

FLOODPROOFING NON-RESIDENTIAL STRUCTURES



Federal Emergency Management Agency



FLOODPROOFING NON-RESIDENTIAL STRUCTURES



Photographs

Sources for photographs included:

- Federal Emergency Management Agency, Washington, D.C.
- U.S. Army Corps of Engineers, Louisville District, Louisville, Kentucky
- U.S. Army Corps of Engineers, Lower Mississippi Valley Division, Vicksburg, Mississippi
- U.S. Department of Housing and Urban Development
- U.S. Water Resources Council

Disclaimer

The statements, recommendations, and procedures contained in this manual are those of Booker Associates, Inc. and do not necessarily reflect the views of the U.S. Government in general or the Federal Emergency Management Agency (FEMA) in particular.

The U.S. Government, FEMA, and Booker Associates, Inc. make no warranty, express or implied, and assume no responsibility for the accuracy or completeness of the information herein.

This manual was prepared under Contract No. EMW-C-0640.

TABLE OF CONTENTS

	PAGE
TABLE OF CONTENTS	iii
SUMMARY	v
 CHAPTER I - INTRODUCTION	
A. Concept of Floodproofing	1
B. Classification of Floodproofing	1
C. Permanent Floodproofing Measures	1
D. Types of Permanent Measures	2
E. Contingent Floodproofing Measures	8
F. Types of Contingent Measures	9
G. Types of Emergency Floodproofing Measures	15
 CHAPTER II - FACTORS THAT INFLUENCE FLOODPROOFING MEASURES	
A. Introduction	17
B. Regulatory Considerations	18
C. Flood Hazard Considerations	21
D. Site Factors	27
E. Functional, Operational, and Economic Factors	28
F. Structure Characteristics	32
 CHAPTER III - FLOODPROOFING DESIGN PERMANENT AND CONTINGENT MEASURES	
A. Introduction	37
B. Elevation on Fill	37
C. Elevation on Posts, Piles, Piers, or Walls	38
D. Watertight Construction (Closure and Flood Shields, Sealants, Membranes)	48
E. Floodwalls and Levees	73
 CHAPTER IV - OTHER FLOODPROOFING MEASURES	
A. Emergency Measures	93
B. Types of Emergency Measures	94
C. Floodproofing Utilities	99
D. Wet Floodproofing Techniques	105
E. Combination of Floodproofing Technique	106
 CHAPTER V - COST AND BENEFITS OF FLOODPROOFING METHODS	
A. Introduction	109
B. Primary Costs	110
C. Secondary Costs	114
D. Future Cost Adjustments	117
E. Expected Damage Reduction	118
F. Annualized Costs	122
G. Summary	123

CHAPTER VI - TYPICAL APPLICATIONS OF
FLOODPROOFING

	PAGE
A. Introduction	133
B. Boulder, Colorado	133
C. Bristol, Connecticut	142
D. Lock Haven, Pennsylvania	149

APPENDICES

A. Bibliography	155
B. Glossary	161
C. Sources of Assistance	167
D. Floodproofing Performances Criteria	179
E. Determination of Expected Flood Depths Using Flood Insurance Maps	195



SUMMARY

A. OBJECTIVE

This manual has been developed to illustrate a broad range of floodproofing techniques that can be used to reduce flood damages to existing or proposed non-residential structures. The manual is primarily directed at local officials, building owners, designers, contractors and other individuals or organizations that are interested in the design and implementation of floodproofing plans.

B. FORMAT

The manual includes six chapters and several appendices. Chapter I introduces the user to the permanent, contingent, and emergency floodproofing techniques that will be addressed in this manual. Chapter II describes the major physical, economic, and social factors that influence the feasibility of floodproofing a structure, and related sources of information and technical assistance. Chapters III and IV provide more detailed information that will facilitate the selection and conceptual design of appropriate floodproofing methods. Representative costs of the various elements of floodproofing are presented in Chapter V. Chapter VI contains several floodproofing case histories. These case histories have been included to provide information on floodproofing plans that are currently in use, and the conditions for which they were designed. Several appendices have also been included in the manual to provide a variety of supplemental information.

C. LIMITATIONS

Only riverine flooding and flooding in non-wave velocity coastal areas are addressed in this manual. Consideration is given to flood characteristics including depth, velocity, and rate-of-rise, and their effects on the various floodproofing techniques. Coastal flooding forces and phenomenon such as wave generated impacts or erosion are not addressed in this manual. The information presented in this manual has been developed specifically to reduce flooding problems associated with non-residential (industrial, commercial, and institutional) structures.

These structures range from small, wood-frame construction, similar to a typical residence, to multi-story concrete and steel structures. Much of the information regarding design criteria, the properties of materials, the values of flood water design forces, and other considerations have been adopted from standard engineering references, building codes, and other documents. Specific case studies (see Chapter VI) were investigated for the purpose of refining and supplementing data presented in prior reports. This manual is intended to serve as a general technical guide on the selection of alternative floodproofing techniques. It must be emphasized that the actual design and construction of the various techniques should involve the services of a registered professional engineer or architect or experienced contractor.



CHAPTER I



INTRODUCTION

A. CONCEPT OF FLOODPROOFING

Floodproofing is a combination of adjustments and/or additions of features to individual buildings that are designed to eliminate or reduce the potential for flood damage. Some examples of floodproofing include the placement of walls or levees around individual buildings; elevation of buildings on fill, posts, piers, walls, or pilings; anchorage of buildings to resist flotation and lateral movement; watertight closures for doors and windows; reinforcement of walls to resist water pressure and floating debris; use of paints, membranes, and other sealants to reduce seepage of water; installation of pumps to control water levels; installation of check valves to prevent entrance of floodwaters at utility and sewer wall penetrations; and location of electrical equipment and circuits above expected flood levels.

For the purpose of this manual, floodproofing of new buildings should primarily be viewed as any method or combination of methods that serve to meet the elevation or watertight floodproofing standards of the National Flood Insurance Program (NFIP) for non-residential structures. Many of these same concepts and methods can also be applied to existing non-protected construction to reduce or eliminate future flood damage.

B. CLASSIFICATION OF FLOODPROOFING

Floodproofing techniques can be classified on the basis of the type of protection that is provided as follows: (1) *permanent measures* (always in-place, requiring no action if flooding occurs); (2) *contingent measures* (requiring installation prior to the occurrence of a flood), and (3) *emergency measures* (improvised at the site when flooding occurs). However, it should be recognized that these classifications are not always clearly defined. For example, a floodwall would normally be considered to be a 'permanent' protection measure even though the success of a particular floodwall design may be dependent upon installation of one or more gates to seal openings. The advantages and disadvantages of alternative floodproofing techniques are also presented in this chapter. Chapters III and IV provide

more specific information that can be used to develop preliminary design concepts for the techniques described herein.

C. PERMANENT FLOODPROOFING MEASURES

Permanent floodproofing measures are those which, once installed, require no further action to be taken when flooding occurs. These measures include closures and sealants, watertight cores, floodwalls and levees, and elevation of the structure. In general, permanent floodproofing measures are most effective when used in areas that are subject to frequent flooding, relatively high flood depths, or where insufficient flood warning time is available to implement contingent floodproofing measures.



For several reasons, permanent floodproofing measures are preferred over contingent or emergency-type techniques. Permanent floodproofing measures reduce reliance on a sophisticated flood warning and preparedness system because the evacuation of the structure occupants may be the only activity that is required prior to the flood. In addition, the effectiveness of these measures during a flood is not jeopardized by human error in installing any portion of the system under adverse conditions that often precede a flood. Furthermore, operation and maintenance costs associated with the floodproofing system will often be less with permanent measures because there is no need to store or maintain parts and supplies that would be required for contingent and emergency floodproofing techniques, and there is no need to train and maintain manpower for installing the floodproofing equipment. Also, permanent floodproofing measures will often meet the minimum floodplain management requirements of the National Flood Insurance Program.

There are also some disadvantages associated with permanent measures. Initial construction costs may be relatively high, particularly for some existing structures and for large floodwall or levee protection projects. Another primary disadvantage to permanent floodproofing is that adjustments made to prevent water from entering a facility may restrict access to and use of certain parts of the structure.

D. TYPES OF PERMANENT MEASURES

1. PERMANENT CLOSURES AND SEALANTS.

A permanent closure basically involves filling an existing window, door, or other opening with some form of water-resistant material, such as concrete blocks, bricks, or cast-in-place concrete (see Figure I-1). The exterior walls and closures will prevent water from entering a building. It is important that walls are impermeable and strong enough to support the expected hydraulic loading, and that the windows and/or doors are not required for the operation of the facility.

Older cast-in-place walls and brick walls generally develop small cracks that allow water to penetrate. In addition, masonry walls are not inherently impermeable; therefore, some seepage can occur through them when they are subjected to floodwaters for extended periods of time. One method that can be used to prevent seepage through a masonry wall is the use of sealants.

A sealant is a waterproof coating that can be applied to the outside of an existing wall, or beneath the veneer of a new wall to reduce or eliminate the wall's permeability. This coating is generally an asphalt-based or polymeric compound that can be painted or sprayed onto the wall. In some cases, polyethylene plastic sheets have been applied in conjunction with these coatings. Some basic considerations for determining whether sealants and closures might be used are:

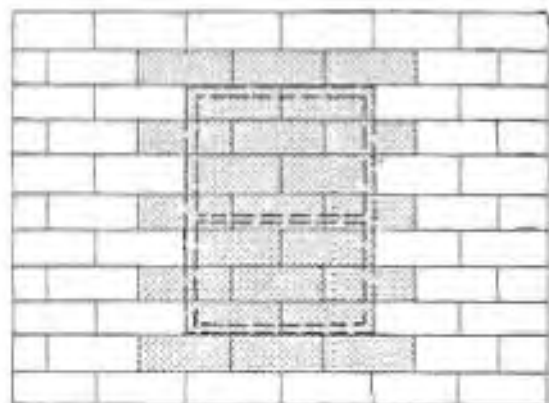

NEW BLOCK USED
 IN CLOSURE AREA
 ORIGINAL WINDOW OPENING

Figure I-1. Permanent Window Closure in existing masonry wall.

- Are the walls of the facility strong enough to withstand the flood-induced loadings without significant structural damage?
- Can these walls be adequately sealed to prevent seepage?
- Can the door, window, or other opening be permanently closed without significantly impairing use of the facility?
- Can a sufficient bond be provided between a closure and the existing wall so that the closure will not fail or crack when subjected to flood loadings?
- Is the floor strong enough to withstand anticipated hydrostatic uplift or buoyancy loads or will a sub-floor drainage system be required?

2. WATERTIGHT CORES. Many existing non-residential buildings do not have watertight walls and often cannot be waterproofed due to physical or economic constraints. In many of these cases some degree of flood-damage reduction can be provided by installing a watertight wall around items within the building that are particularly susceptible to flood damage. This type of watertight enclosure is normally constructed of cast-in-place concrete. However, concrete block or brick may be used if an effective waterproofing compound is applied and sufficient

strength can be developed. Watertight cores are particularly effective when costly items are located together in a small part of the building and it is not feasible to relocate them to non-floodprone areas. For example, important records, vital utilities, or expensive equipment might be enclosed by such a core. (See Figure 1-2.) If properly designed and constructed, a watertight core can be a very cost effective damage-reduction tool for a facility which could not otherwise be floodproofed.

3. FLOODWALLS AND LEVEES. Another method of floodproofing a non-residential structure is the use of small floodwalls or levees. Although these have traditionally been considered as structural flood control alternatives for protecting a large area or a number of structures, they can be a practical and economical floodproofing technique for protecting single or small groups of structures. Floodwalls and levees have been constructed in a wide variety of shapes and sizes throughout the United States. Basically, these facilities act to keep water away from a structure.

Floodwalls are generally of masonry or concrete construction and there are a wide variety of configurations to meet different site conditions. Some of the more common shapes are shown in Figure 1-3.



Figure 1-2. Typical Applications of Watertight Core Floodproofing

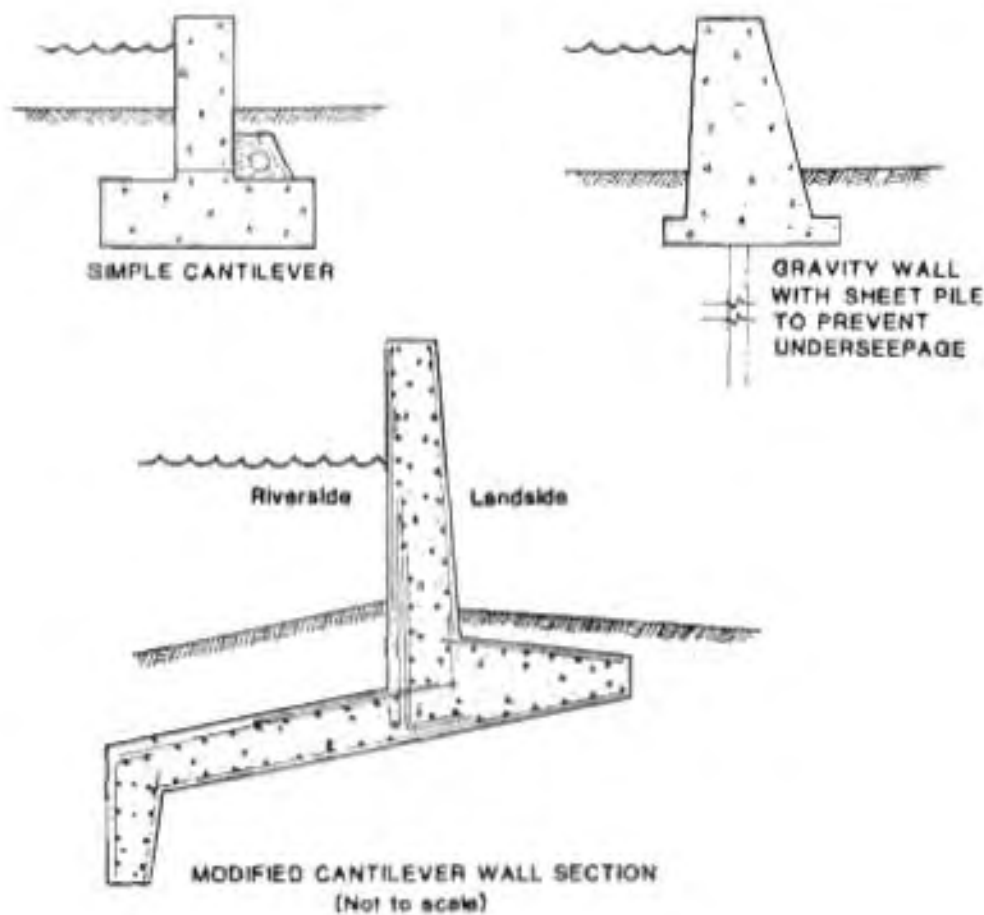

Figure 1-3. Typical Floodwall Configurations

Levees are earth embankments that have low-to-moderately sloped sides, a wide crest, and a cut-off trench or wall as shown in Figure 1-4. The side slopes are usually 3:1 or less to provide greater structural mass and stability. The crest can vary in width from a minimum of 2 feet depending on stability requirements related to the height of the levee and on any allowances which need to be made to facilitate access for vehicles or maintenance equipment.

One of the primary advantages of floodwalls and levees is that they can be used to protect any type of structure. There is no need to alter the building, to block in windows or doors, or to build interior barriers. Floodwalls and levees also have an advantage in that they can be used in areas with relatively high

flood depths. However, high floodwalls and levees are very expensive and pose a significant safety hazard if they are not designed and constructed properly, or their design protection level is overtopped.

One major drawback to the use of levees is the amount of space which they require. For example, if a levee with 3:1 side slopes and height of eight to ten feet is placed on a two-acre site, the levee will occupy approximately one-half of the site (this relationship will vary based on the shape of the site). However, with its relatively flat slopes, the levee can provide open space that may be used for storage or some other activity that does not conflict with proper levee maintenance. Figure 1-5 demonstrates how levee width varies with height.

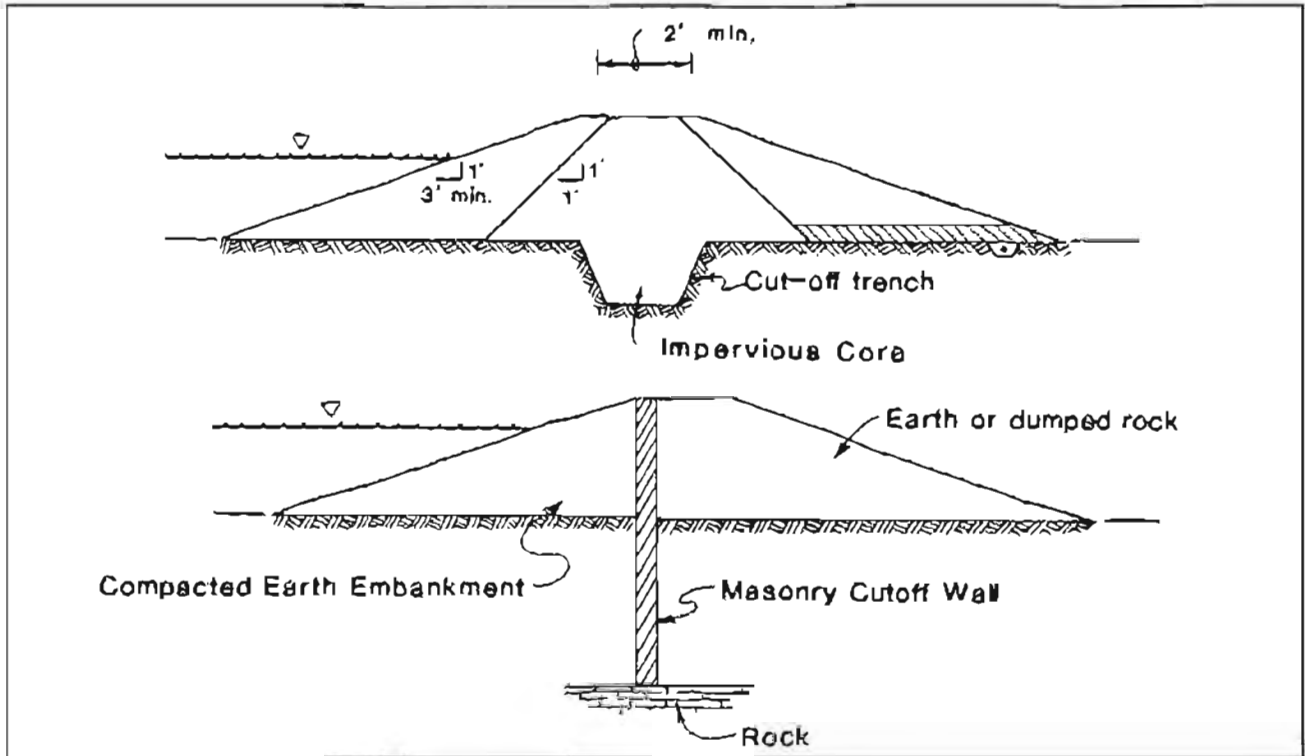

Figure I-4. Typical Levee Configurations

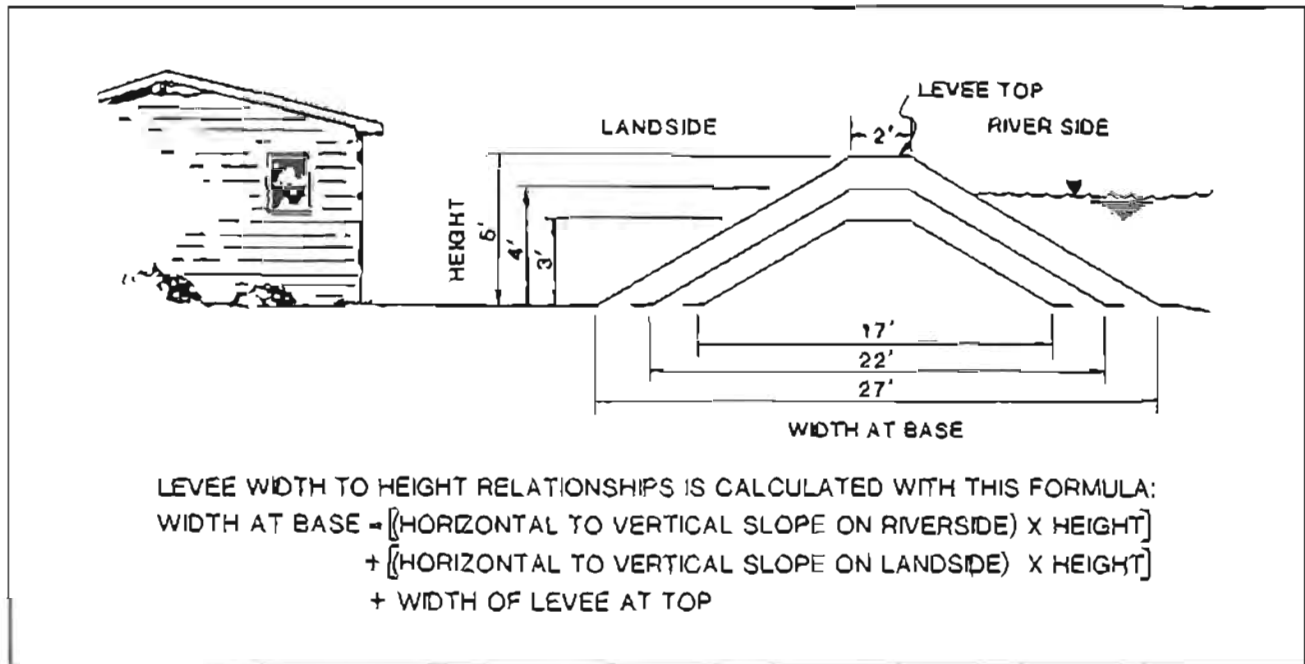

Figure I-5. Section View of Protective Levee

Another common problem associated with levees and floodwalls is related to the need to provide for drainage of rainfall and runoff that collects behind them. Normally this is accomplished by draining all internal water to a central point. Interior drainage may be pumped to the other side of the floodwall or levee, or a valve may be provided to allow drainage by gravity, while preventing backflow during flood periods (see Figure 1-6). Also of considerable importance in the design and construction of floodwalls and levees is underseepage. In areas where the soils are pervious or floods are of considerable duration, seepage under the structure could result in flooding of the site behind it. In such cases, some type of pump system, cut-off trench, sheet piling, or wall should be provided as shown in some of the examples in Figures 1-3 and 1-4.

within the same amount of space that would be required without elevation. If a structure is to be elevated on fill, a considerably larger amount of space may be required to accommodate grade changes on the sides of the structure.

4. ELEVATION. Elevation of a non-residential structure above the base flood elevation is a protective measure that is often feasible for new construction and selected existing structures. Structures may be elevated on concrete columns (Figure 1-7), on compacted fill (Figure 1-8), or a variety of other foundation types. Elevation of a building on walls, columns, piles, posts, or piers can be accomplished

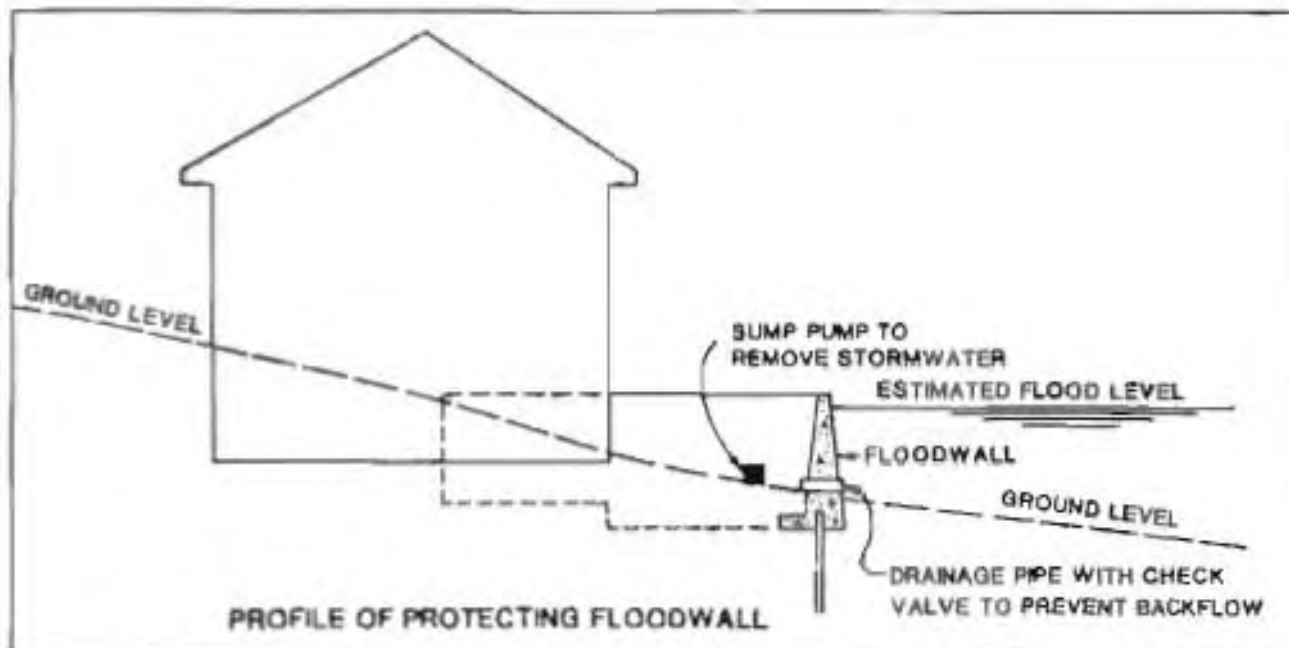

Figure 1-6. Flood Protection With Low Floodwall



Figure I-7. Elevation on Columns



Figure I-8. Elevation on Compacted Fill

Elevated structure design must be capable of resisting the loads caused by flooding including hydrostatic, hydrodynamic, and debris impact. Substantial modifications to standard walkways, steps, ramps and utility systems may also be required. The elevated structure's floor must be insulated and the utility systems leading to the structure must be protected from damage associated with floods and temperature extremes. In addition, elevation of the structure must be designed so that it does not interfere with access to the structure. For example, if a warehouse is to be elevated, some provision must be made for maintaining the required dock height. This problem might be resolved by raising the loading dock area on fill material (see Figure I-9). Similar problems may be encountered if the facility to be elevated is situated near a railroad or river dock. Ideally, plans for an elevated structure should include provisions for safe exit from the structure during a flood. This may be accomplished by elevated walkways or through appropriate grading of the site. For structures where this is not possible, adequate flood warning and evacuation plans must be developed to ensure that occupants are not stranded in the facility during a flood.

Although elevation is most applicable for new construction, there are some cases where this technique can be used successfully to protect existing structures from flood damage. Techniques are available to raise almost any type of structure. However, cost effective elevation of existing structures is generally limited to light, 1-2 story buildings that have a floor system that can be lifted with the structure walls as a single unit. Generally, wood frame buildings constructed on a crawl space or basement foundation are the most suitable candidates for elevation.

E. CONTINGENT FLOODPROOFING MEASURES

Although permanent floodproofing measures certainly have advantages in terms of providing protection from flood damages, they often have accompanying disadvantages such as restricted access and inefficient utilization of space. When these factors represent major obstacles in the application of permanent floodproofing techniques, the use of contingent floodproofing measures may be appropriate.

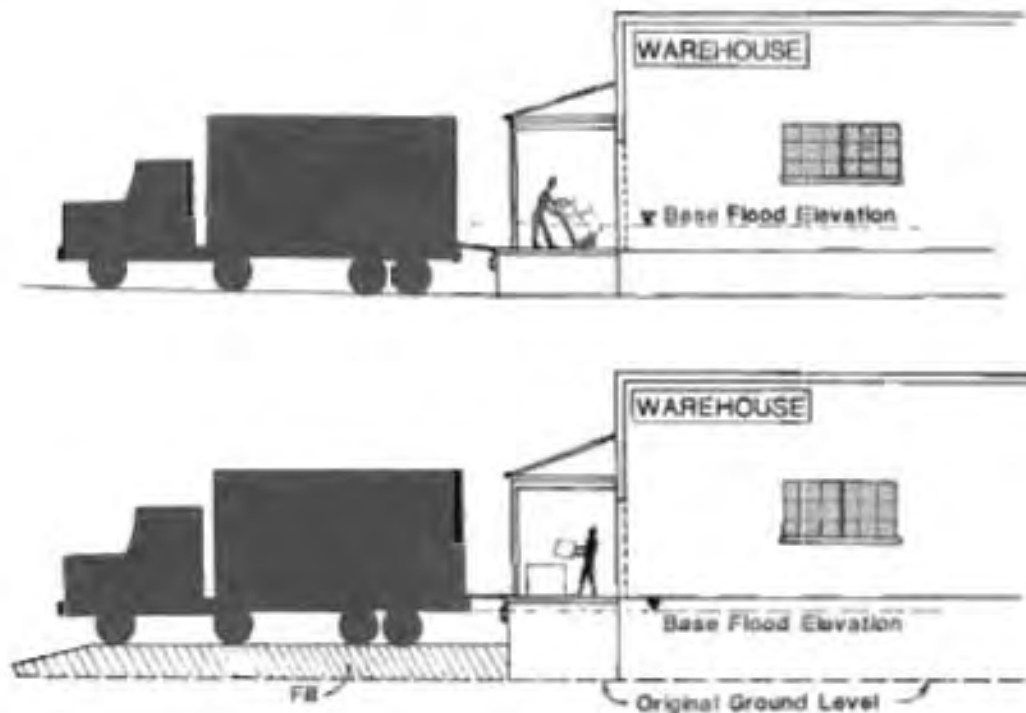

Figure I-9. Elevation of an Existing Warehouse

Contingent floodproofing measures are those that require some type of installation, activation, or other preparation immediately prior to the occurrence of a flood. These measures include flood shields, watertight doors, and moveable floodwalls. In some cases, flood protection provided by levees, floodwalls, or waterproof cores will require access openings that must be sealed with shields or doors during flood events. Obviously, the success of this type of system is dependent upon the ability to install and secure the flood shields and other protective devices prior to flooding. *As with permanent floodproofing measures, the walls and floors must be strong enough to withstand loading forces and significant leakage.*

The primary advantage of contingent floodproofing systems is that components may be moved aside or stored during non-flood periods allowing full access to the doors, windows, and other openings. In addition, contingent floodproofing methods are often very cost effective when protecting against relatively shallow flood depths, especially when a small number of openings are involved. Another advantage of contingent measures is that they are often the most adaptable and feasible techniques for use of existing non-residential structures. Also, these techniques may satisfy the minimum floodplain management requirements of the National Flood Insurance Program.

Although convenience, cost, and adaptability provide major incentives to the use of contingent floodproofing measures, there are several potential disadvantages that must be considered. The major disadvantage is that a contingent system is subject to human error associated with applying the system's components. Inappropriate response may involve inadequate recognition of flood hazards, improper installation, failure to install an element of the system due to an oversight, inability to find elements or installation equipment due to poorly planned or maintained storage areas, or improper training of the installation team. Each of these factors must be carefully considered during the selection and design of contingent floodproofing measures.

F. TYPES OF CONTINGENT MEASURES

1. **FLOOD SHIELDS.** Flood shields are the most commonly used contingent floodproofing method. A flood shield is a watertight barrier designed to prevent the passage of water through doors, windows, ventilation shafts, or any other opening in a structure that might be exposed to flooding. Flood shields have customarily been made of steel or aluminum. However, any material that can be easily maintained and is capable of providing sufficient strength and water resistance may be used.

So that access to protected areas is maintained, flood shields are usually installed only when flooding is imminent. Normally some type of gasket or seal is required to ensure that the shield is watertight. Additionally, the shield should be attached by bolts or some other means to provide proper contact for sealing. It must be stressed that flood shields may only be installed where the walls of the building and the opening's framing system are strong enough to withstand flood-induced forces.

Some mechanical means of transportation and placement should be incorporated in the design of large, heavy shields. As shown in Figure I-10, shields may be mounted on tracks or hinges so that they can be slid or lowered into place. Heavy flood shields may also be placed with a fork lift, overhead hoist system, or any other type of mechanical or electrical device. It is critical that the selected system must have an independent power source because power outages often accompany major floods.

One disadvantage of this floodproofing system is the storage requirement for flood shields. Shields must be located as near to the opening as possible along with any tools required for installation. If storage requirements are improperly implemented, the entire system for protection can fail.

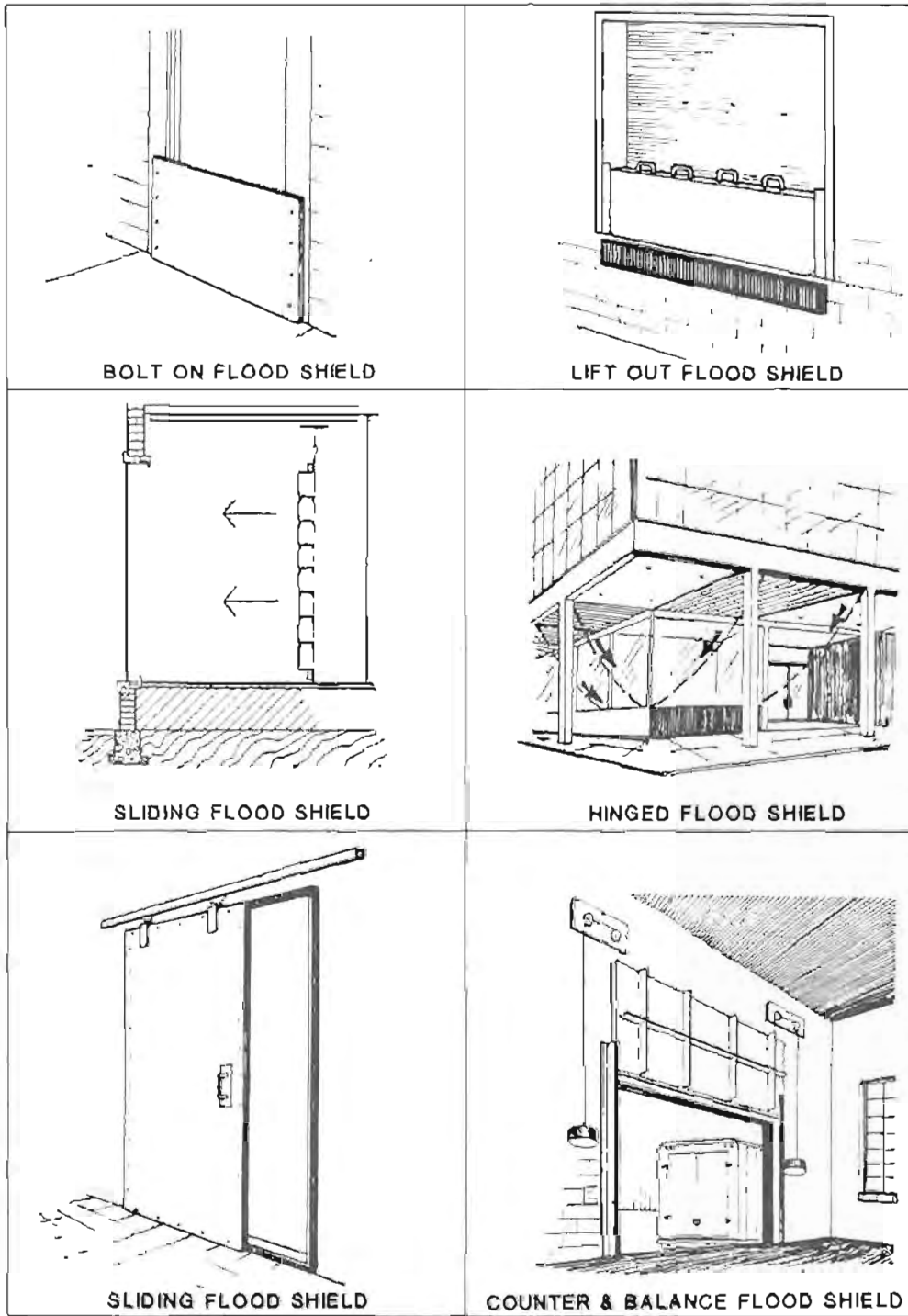

Figure I-10. Typical Flood Shields

2. WATERTIGHT DOORS. Watertight doors are very similar to sliding or hinged flood shields in purpose, yet they are designed to function as actual doors that are used during normal operating conditions. This type of door can be closed and sealed by a simple latch mechanism (see Figure I-11), without the use of bolts that are normally used to secure a flood shield.

Many of the advantages of watertight doors are obvious. Because they are permanently mounted at the area where they are to be used, a separate storage area is not required. Because they will be used on a regular basis, they are more likely to be kept in proper working condition. For structures where all openings could be protected with this type of closure, there would be no need for a contingency plan to floodproof the facility during non-working hours. Waterproof doors are easily secured, thus their use would reduce the amount of time required to implement a floodproofing plan that contained other contingent or emergency measures.

The primary disadvantages to this type of door include their weight (which makes frequent opening and closing difficult), and their cost.

3. MOVABLE FLOODWALLS. Movable floodwalls may be installed in situations where the construction of a conventional floodwall or levee is not acceptable because of related impacts on accessibility or aesthetic values. Several movable floodwall designs have been developed to date. A few of the more common designs are described in this section.

The folding floodwall consists of a flood barrier which is hinged along the bottom so that it can be lowered to a horizontal position to form a walk, or to fit flush with existing ground or pavement. A floodwall in Monroe, Louisiana is based on this concept. Figure I-12 shows a section view of the floodwall in both the raised and the lowered position.



Figure I-11. Watertight Hinged Door

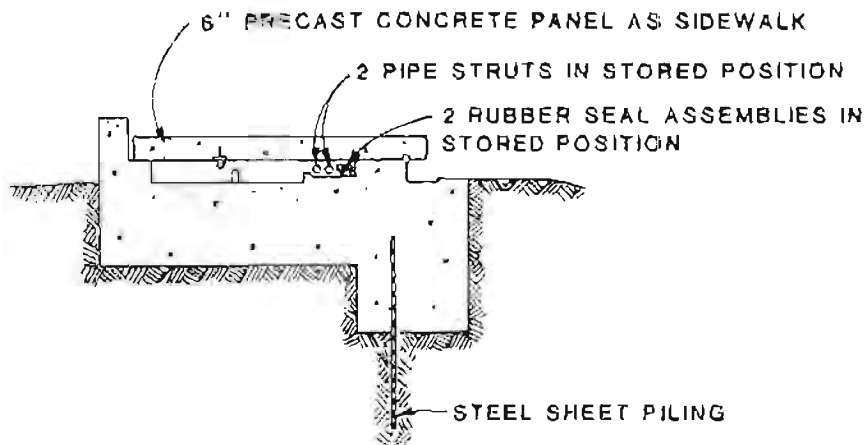
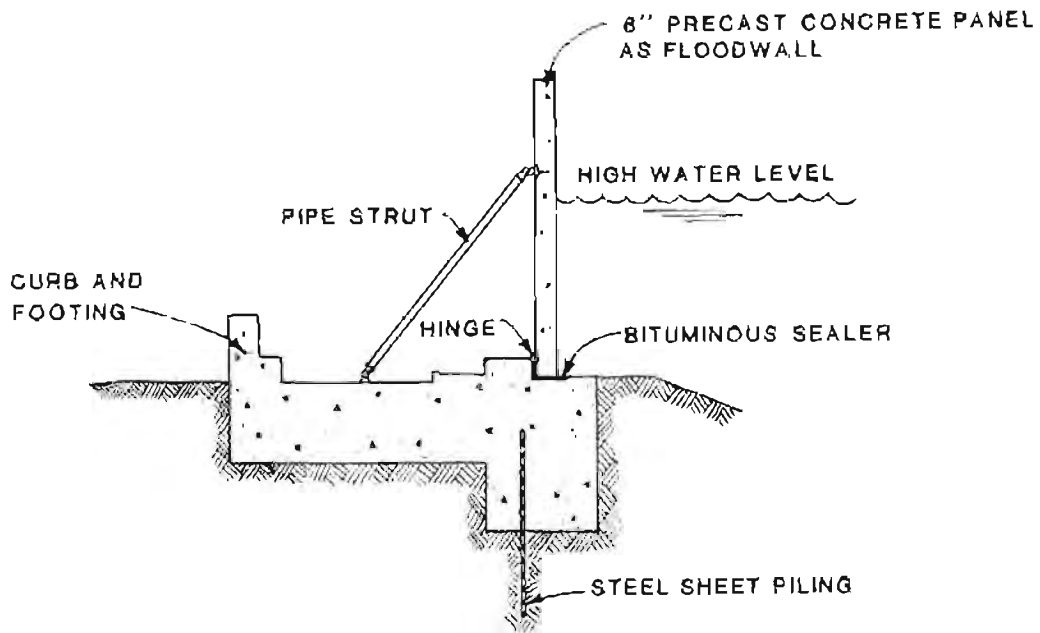

Figure I-12. Folding Floodwall
(Precast Concrete Flood Shield)
Based on Floodwall in Monroe, Louisiana That Was Designed
and Constructed by the Vicksburg District Corps of
Engineers

Because these panels are quite heavy (about 500 pounds per foot of length), they must be raised and lowered by means of a mechanical hoist and must be held in place while the bolts are manually secured. This system is not particularly quick to install. Another floodwall of this type includes a pneumatic lifting system and telescoping struts so that air compressors could be used to lift the panels, thereby substantially reducing installation time.

For those cases where relatively shallow flooding is expected (water depths of two feet or less), a folding floodwall could be constructed using metal shields. These shields could be braced by either permanent or movable posts. The shield faces that are exposed when they are in the lowered position would need to be surfaced with an appropriate texture for any pedestrian or vehicular traffic that would be expected (see Figure I-13).

Another movable floodwall that is suitable for low depth areas involves mounting a flood shield so that it can slide up and down in a recessed area below grade and the flood barrier position as shown in Figure I-14. This particular design has an advantage over the flood shield wall because of the convenient location of the panels. It also has some advantage over the folding or hinged floodwall in that any type of walk, pavement, or grassed area can be accommodated on each side.

If a movable floodwall is correctly designed, built, maintained, and installed it should provide complete protection for a non-residential structure while allowing full view of and access to the structure during normal business operation. However, these advantages must be weighed against disadvantages associated with relatively high construction cost and maintenance requirements.

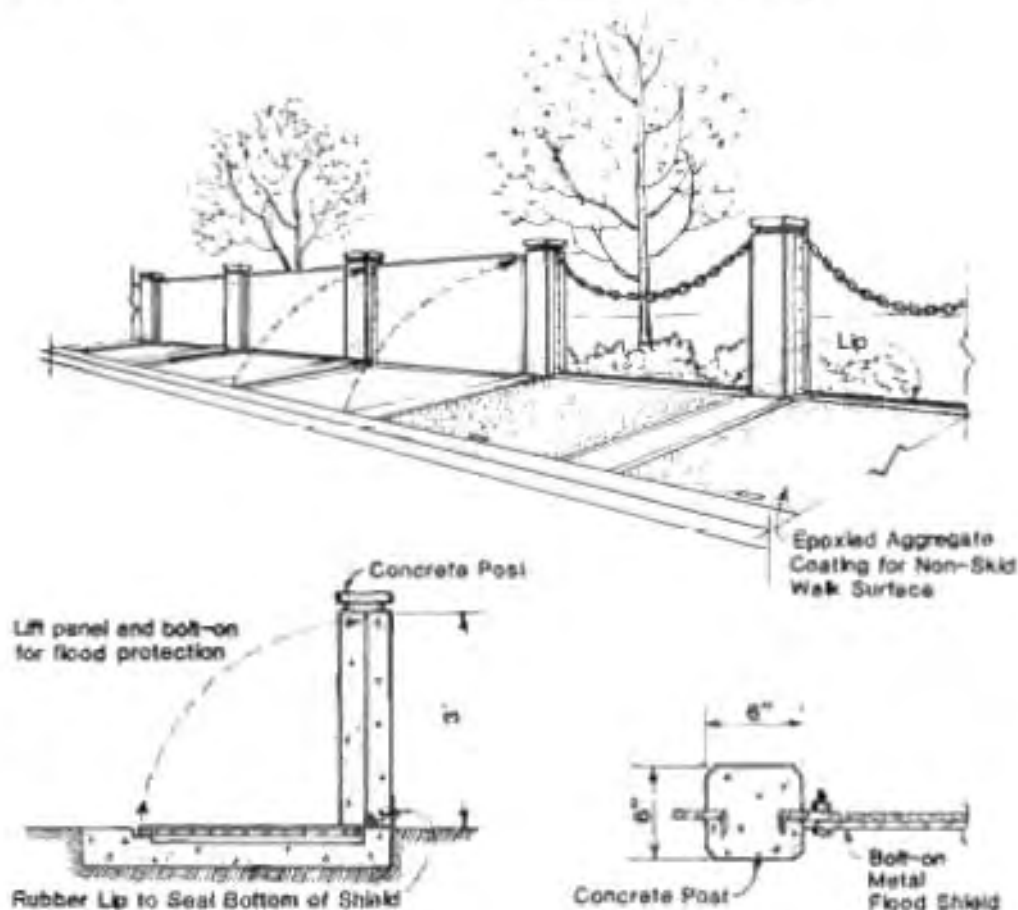

Figure I-13. Folding Floodwall (Metal Flood Shield)

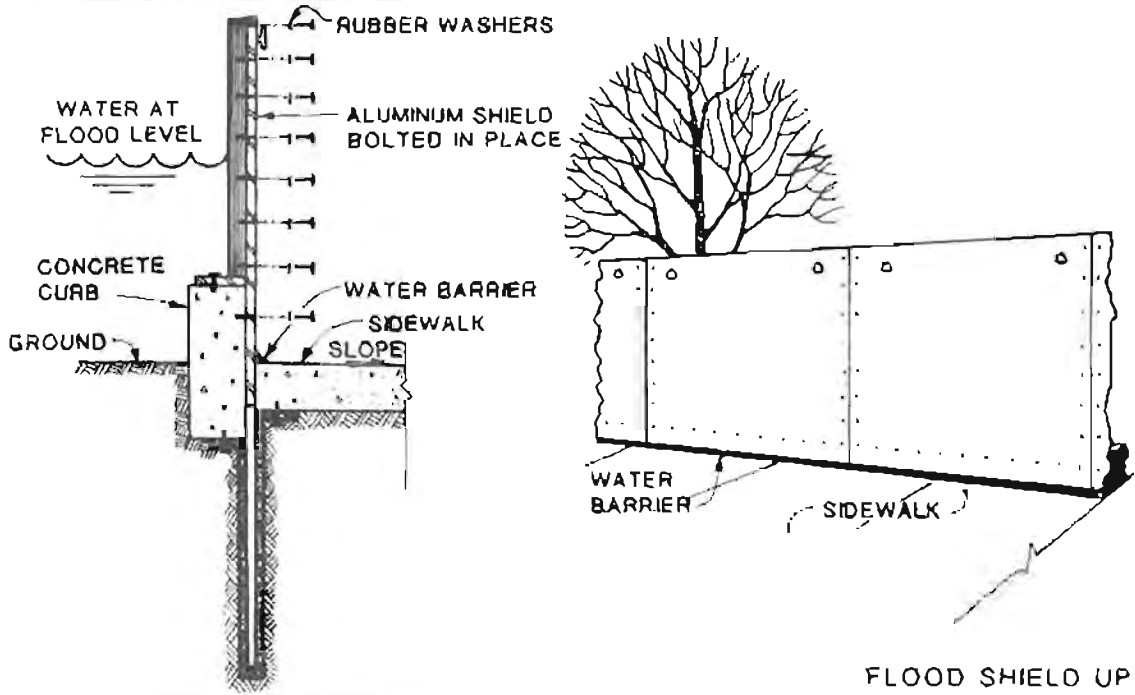
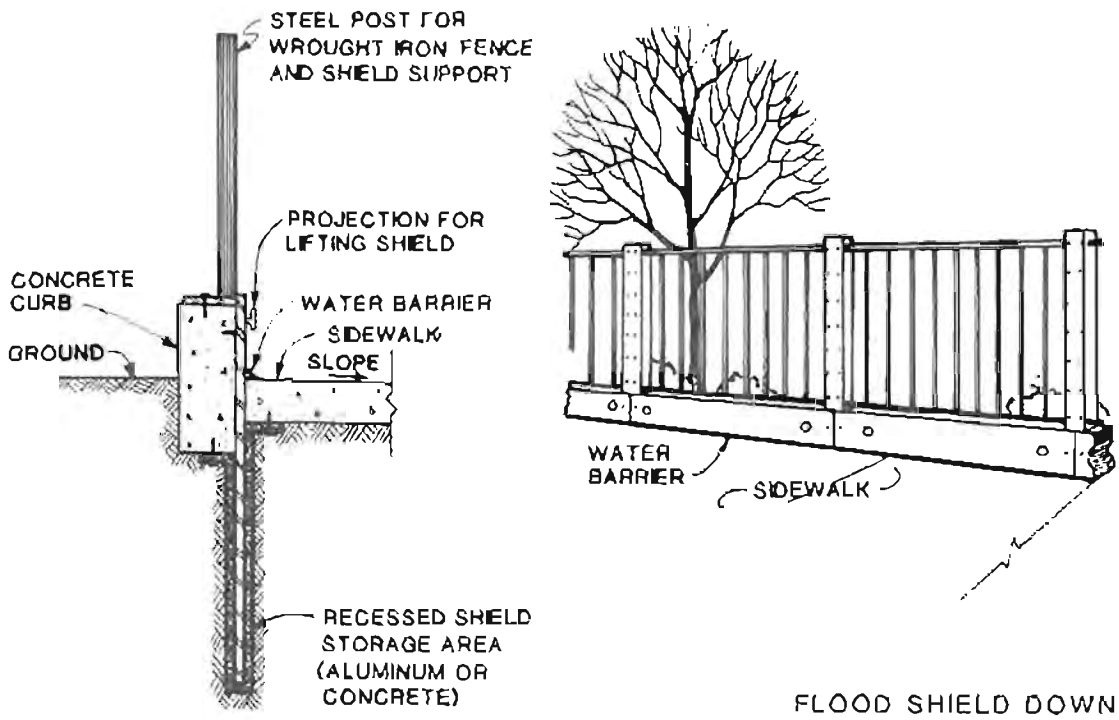

Figure I-14. Recessed Floodwall (Aluminum Flood Shield)

G. TYPES OF EMERGENCY FLOODPROOFING MEASURES

Emergency floodproofing measures are discussed in detail in Chapter IV and are summarized below. These techniques are characterized by their ability to be initiated on relatively short notice using previously obtained and stored materials.

The primary advantage of an emergency method is low cost. Sand and timber are the primary materials and although these measures labor intensive, volunteers are often used. These methods are most effective in flood areas where water velocities are low and depths are shallow, and where floodwaters rise slowly.

A major disadvantage of emergency measures is that substantial advance warning is required to mobilize personnel and install emergency barriers. In addition, in the event of an unexpected increase in the flood magnitude or rate of rise, the emergency measures may fail. It should be noted that emergency measures do not satisfy the minimum requirements for watertight floodproofing as set forth by the National Flood Insurance Program (NFIP), due to their reliance on human intervention. The most common techniques for emergency flood protection include the following:

1. SANDBAG DIKES - This is the most common emergency technique and consists of stacking plastic burlap sandfilled bags atop one another.

2. EARTHFILL CRIB RETAINING WALLS - These temporary walls are typically constructed by placing soil between two timber formed walls.

3. STOP LOG BARRIERS - Stop log barriers are typically constructed by stacking small timber planks on top of each other by dropping them into permanent side channels.

Other techniques used to reduce flood damages are discussed in Chapter IV.



CHAPTER II



FACTORS THAT INFLUENCE FLOODPROOFING FEASIBILITY

A. INTRODUCTION

Many factors influence the decision making process for determining the feasibility of floodproofing options. The optimum solution would be one that:

- Provides for reduction in damages for the selected or **required** design level and does not result in **increased** damages to other property.
- Is responsive to all applicable floodplain regulations.
- Provides for the safety of persons on and adjacent to the site.
- Is cost effective with regard to installation, maintenance and operation of the system.
- Is acceptable to the property owner, employees and the general public with regard to operational efficiency and impacts on the surrounding environment.

To develop a floodproofing plan that can meet these performance goals, it is necessary to conduct a systematic evaluation of physical, social, and economic factors that influence the feasibility of floodproofing. In most situations, it will be necessary to collect basic information related to each of the major categories shown in Figure II-1. This information is required to: (1) identify viable construction sites and/or floodproofing alternatives, (2) develop preliminary design concepts, and (3) select, refine, and implement an optimum floodproofing plan for a new or existing structure. This chapter identifies the specific types of information that may be required, how that information may be used, and potential data sources. The chapter has been arranged to reflect the general outline of information provided in Figure II-1. This format results in an initial discussion of the potential regulatory context of floodproofing, followed by a presentation of physical factors that impact floodproofing alternatives. The chapter concludes with a summary of factors that influence the design, use, and acceptability of floodproofing alternatives.



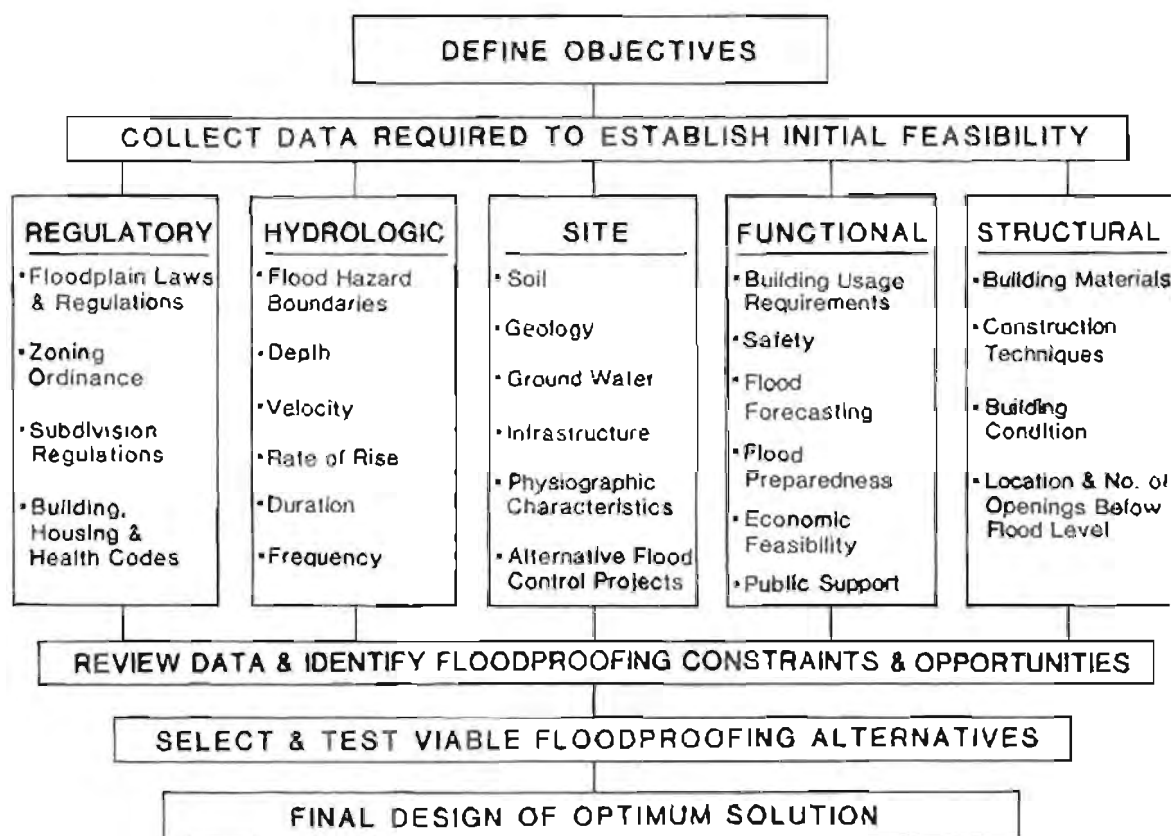

Figure II-1. General Floodproofing Design Process

B. REGULATORY CONSIDERATIONS

A variety of floodplain management programs have been developed and adopted throughout the United States as part of a long term effort to reduce flood damages. The floodproofing analysis process should begin with contacts to appropriate federal, state, regional, and local agencies to identify sources of technical assistance and to develop an understanding of floodplain regulations and other code requirements that are applicable to the proposed action. Figure II-2 provides an overview of the general range of floodplain management services that are available through various levels of government. As described below, the programs and regulations that are administered by these agencies can influence decision on where floodproofing may be applied, what techniques may be used, and the design of specific floodproofing components.

1. FEDERAL PROGRAMS. There are a variety of federal agencies that have direct or indirect involvement in flood protection issues. Several agencies support major research and program efforts in specific areas of floodproofing. For example, many of the Corps of Engineers District Offices have been involved in floodproofing projects and all of them provide flood and floodplain related technical assistance including information on floodproofing through the Flood Plain Management Services Program. The Corps of Engineers also maintains a National Advisory Committee on Floodproofing that has directed several floodproofing demonstrations and tests. Other federal agencies that support major programs related to floodproofing include the Federal Emergency Management Agency and the Soil Conservation Service.

FLOOD PLAIN AGENCIES	Floodwater Control	Floodproofing Information	Preserve Channel Capacity	Development Regulations	Land Use Controls	Public Information	Flood Fighting	Post-Flood Relief	Flood Warning System
• FEDERAL EMERGENCY MANAGEMENT AGENCY		●		●		●	●	●	
• U.S. ARMY CORPS OF ENGINEERS	●	●	●	●		●	●	●	●
• U.S. SOIL CONSERVATION SERVICE	●	●	●			●		●	
• DEPARTMENT OF HOUSING AND URBAN DEVELOPMENT				●				●	
• NATIONAL OCEANIC AND ATMOSPHERIC ADMINISTRATION						●			●
• U.S. GEOLOGICAL SURVEY						●			
• FEDERAL HIGHWAY ADMINISTRATION	●		●				●		
• STATE FLOODPLAIN MANAGEMENT COORDINATING AGENCY	●	●	●	●	●	●			
• REGIONAL AUTHORITIES	●	●	●	●		●	●	●	
• LOCAL GOVERNMENT PLANNING AGENCIES				●	●	●			

Figure II-2. Floodplain Management Services

Appendix C provides a listing of agency offices that may be contacted to obtain information about programs and regulations that apply to a specific project. In addition, agency representatives may be able to provide technical assistance in the form of basic information and reports.

2. NATIONAL FLOOD INSURANCE

PROGRAM. The National Flood Insurance Program (NFIP) represents the primary floodplain regulatory program that has been adopted at the federal level. The NFIP is administered by the Federal Insurance Administration of the Federal Emergency Management Agency (FEMA). The NFIP's primary purpose is to reduce the amount of personal

hardship and property damage associated with flooding. The program makes flood insurance available to communities that implement comprehensive land use planning and management to reduce flood damage in their jurisdictions. Community response to this requirement generally involves the adoption of zoning, building code, and development regulations and strategies that feature various damage mitigation measures for new construction and substantial improvements to existing structures in identified flood hazard areas. The minimum standards for floodplain regulations, as published by FEMA, (44 CFR Part 60) require that: (1) all new or substantial improvements to residential buildings have the lowest floor (including the basement) elevated to or above the base flood

elevation (BFE); (2) all new or substantial improvements to *non-residential* buildings must have the lowest floor (including the basement) elevated or floodproofed to or above the BFE. Under the floodproofing option, structures must be made watertight, with walls substantially impermeable to the passage of water and with structural components that are able to resist flotation, collapse, lateral movement, or other forces associated with a 100-year flood. Furthermore, specific floodproofing plans must be certified by a registered professional engineer or architect as meeting the minimum requirements of the National Flood Insurance Program.¹ Floodproofing techniques are not allowed in 'V'-zones (Coastal High Hazard Areas) as indicated on the Flood Insurance Rate Maps.

3. STATE PROGRAMS. The majority of states have adopted some form of floodplain regulations that must be considered during the planning of a floodproofed facility. Some state floodplain management laws and regulations do address floodproofing directly. State regulations also often include provisions that specify the amount of encroachment a facility may have on the floodplain, regulate the location of potentially hazardous materials, and restrict the location of such activities as schools, hospitals, and public services facilities. In addition, state building and utility permit systems may also impact the location and design of floodproofing measures. In association with the NFIP, each state has a designated State Coordinating Agency that provides assistance required to implement the program. These agencies (see Appendix C) generally represent the best place to begin an investigation of regulatory issues and to identify sources of technical assistance.

¹ Section 60.3 (c)(4) of the National Flood Insurance Program Regulations states that "...where a non-residential structure is intended to be made watertight below the base flood level, (i) a registered professional engineer or architect shall develop and/or review structural design, specifications, and plans for the construction, and shall certify that the design and methods of construction are in accordance with accepted standards of practice...and (ii) a record of such certificates which includes the specific elevation (in relation to mean sea level) to which the structures are floodproofed shall be maintained with the official designated by the community...



4. REGIONAL JURISDICTIONS. There are several regional jurisdictions within the United States that have an interest in floodplain management activities. These include several federal and state River Basin Commissions and the Tennessee Valley Authority. These agencies participate in a wide range of structural and non-structural floodplain management activities. The listing provided in Appendix C may be used to contact specific agency representatives.

5. LOCAL AGENCIES. In response to the National Flood Insurance Program and other federal and state floodplain management programs, most local jurisdictions have implemented regulatory programs through their zoning, building code, or

other permit agencies. Zoning ordinances may specify allowable uses for a particular floodplain zone and various restrictions on the location and size of a structure. In addition to use of zoning ordinances, a variety of other regulatory tools such as subdivision regulations, building codes, sanitary regulations and plumbing codes are used by local jurisdictions.

C. FLOOD HAZARD CONSIDERATIONS

To develop an effective floodproofing scheme for a facility, several hydrologic factors must be properly evaluated. These factors include the regulatory floodplain boundaries and the anticipated flooding characteristics for the site such as flood velocity, duration, rate of rise, and frequency. This type of hydrologic base data may be available from several agencies as summarized in Figure II-3, or may have to be independently determined for the specific site.

AGENCIES	DATA TYPE													
	Crestal Surveys & Reports	Flood Control Measures	Flood Boundary Maps	Flood Insurance Rate Maps	Floodplain Information Reports	Flood Records & Photographs	Floodplain Technical Studies	Hydrologic Studies	National Flood Insurance Program Regulations	State Floodplain Regulations	Technical Assistance	Topographic Maps	Zoning Ordinances And Maps	Soil Maps
• Local government planning agency or municipal engineer	●	●	●	●	●	●	●		●	●	●	●	●	
• State floodplain management coordination agency	●	●	●	●		●	●		●	●	●			
• Federal Emergency Management Agency	●	●	●	●					●		●			
• National Oceanic and Atmospheric Administration (Department of Commerce)	●				●	●								
• Soil Conservation Service (U.S. Dept. of Agriculture)		●			●	●								●
• U.S. Army Corps of Engineers (Department of Defense)	●	●	●	●	●	●	●				●	●	●	
• U.S. Geological Survey (Department of the Interior)					●	●	●	●				●		
• Regional Authorities (e.g. T.V.A.)		●			●	●	●				●	●		

SOURCE: ADAPTED FROM DESIGN GUIDELINES FOR FLOOD DAMAGE REDUCTION, FEMA, 1981

Figure II-3. Summary of Hydrologic Data Sources

If a Flood Insurance Study has been developed by FEMA, the study will often offer the most current and detailed information that is available (see Figure II-4). Many such studies will include a 'Flood Boundary and Floodway Map' and supplementary stream profiles. For those areas where data is not available, hydrologic specialists can develop the necessary design information from site specific investigations. These may involve development of hydrologic relationships in some cases using knowledge of historical flood events and the physiographic conditions of the site and watershed. Detailed information regarding the specific structural loading impacts that floodwaters can exert on structures is provided in Appendix D (Floodproofing Performance Criteria). A general overview of considerations associated with other hydrologic factors is provided below.

1. FLOOD HAZARD BOUNDARIES. The proper identification of flood hazard boundaries is significant in that these boundaries define the regulatory floodplain, and the relative extent of flood hazard within various floodplain zones. Flood hazard boundary classifications must also be investigated to determine areas that may restrict the use of certain floodproofing measures such as areas identified as the regulatory floodway or areas that are subject to high flood velocities.

In accordance with the NFIP requirements, the 100-year or 'base flood', that is, the flood having a one percent chance of being equalled or exceeded in any given year is used as the basis for floodproofing designs for new and substantially improved construction. Base flood elevations may be determined at any point within the 100-year floodplain by referring to the appropriate 'Flood Insurance Rate Map' (see Figure II-5). For areas that do not have a Flood Insurance Study, floodplain boundaries may be obtained from other sources such as a Flood Hazard Boundary Map, floodplain information studies, zoning maps, or through analyses performed by hydrologic/hydraulic specialists.

2. DEPTH. The depth of flooding associated with the required regulatory flood (usually the 100-year return frequency or other selected protection level) is one of the primary factors that influence floodproofing design. This factor must be determined to design against over-topping of the system (freeboard consideration) and to formulate a design that can withstand associated loading pressures.

STUDY ELEMENT	FLOODPLAIN DATA ¹	FLOOD HEIGHTS	ELEVATION REFERENCE MARKS	FLOOD PLAN BOUNDARIES	FLOODWAY DATA	FLOOD INSURANCE ZONES
FLOOD INSURANCE STUDY REPORT	●	●				●
FLOOD BOUNDARY & FLOODWAY MAP (FBFM)			●	●	●	
FLOOD INSURANCE RATE MAP (FIRM)		●	●	●	● ²	●

¹ Flood profiles, water velocity, floodway widths, historical flood information, etc.

² Some FIRM's do not depict floodway data.

Figure II-4. Summary of Key Information Provided by Flood Insurance Study Effort

There is considerable variation among floodproofing techniques regarding the maximum flood depth for which each method can be applied (see Figure II-6). Elevation of non-residential structures on posts, piers, or piles as high as 12 feet is not uncommon. Elevation on fill has been used to protect against flooding depths in excess of 10 feet depending upon the characteristics and availability of fill material. The upper limit of permanent and contingent closure systems is generally limited by the building's wall or floor strength and cost considerations. Existing non-residential buildings of reinforced concrete or heavy masonry construction can often resist flood loading up to depths of four to six feet, including allowance for both hydrostatic and hydrodynamic loads (see Chapter III and Appendix D).

Estimates of flood depths for a particular site can normally be inferred from flood insurance studies or similar hydrologic reports. Where a Flood Insurance Study Report is available, the elevation of various probability events (100-year, 500-year) for a particular stream channel may be obtained from a flood profile (see Figure II-7). For floodproofing purposes, the depth of flooding may be calculated by subtracting the elevation of the lowest grade adjacent to the structure to be floodproofed from the Base Flood

elevation as determined from an appropriate flood profile. If a Flood Insurance Study or other floodplain studies have not been conducted, flood depths may be determined through site specific evaluations or historical information.

3. VELOCITY. In addition to depth of flooding, velocity has a direct relationship to the amount of force applied to a structure by floodwaters. Water velocity also can result in higher depths of flooding on the upstream side of a building. An allowance for freeboard, particularly on upstream side of a facility, can address this concern. The velocity of flow also determines the force which could be applied to the structure through the impact of objects being carried by the flood (see Appendix D for more detailed information on flood loads). High velocities also have an impact on the design of levees or embankments that can be subject to scour and erosion.

Experience has shown that floodproofing is generally not appropriate in areas where flood velocities exceed 10 feet per second. Information on stream velocity may be obtained from the Floodway Data Table contained in the Flood Insurance Study Report, other technical studies, or through site specific hydrologic investigations.

	DEPTH	VELOCITY	RATE OF RISE	DURATION
LEVEES	4-7'	< 10 FT/SEC	MAY NEED ADVANCE WARNING IF GATES NEED TO BE INSTALLED	NO CONSTRAINTS
FLOODWALLS	4-7'	< 12' FT/SEC		NO CONSTRAINTS
CLOSURES	4-8'	< 8 FT/SEC	NEED 5-8 HOURS ADVANCED WARNING	< 24 HOURS
FILL	10'+	< 10 FT/SEC	WILL REQUIRE EVACUATION TIME UNLESS FILL CONNECTS TO HIGH GROUND	NO CONSTRAINTS
PILES, PIERS COLUMNS	10-12'	< 8 FT/SEC	NEED ADEQUATE EVACUATION TIME	NO CONSTRAINTS

* BASED ON STATE OF THE ART REVIEW OF ACTUAL SITES, INFORMATION PRESENTED IS GENERAL AND WARRANTS CAUTION

Figure II-6. General Limits of Floodproofing Methods

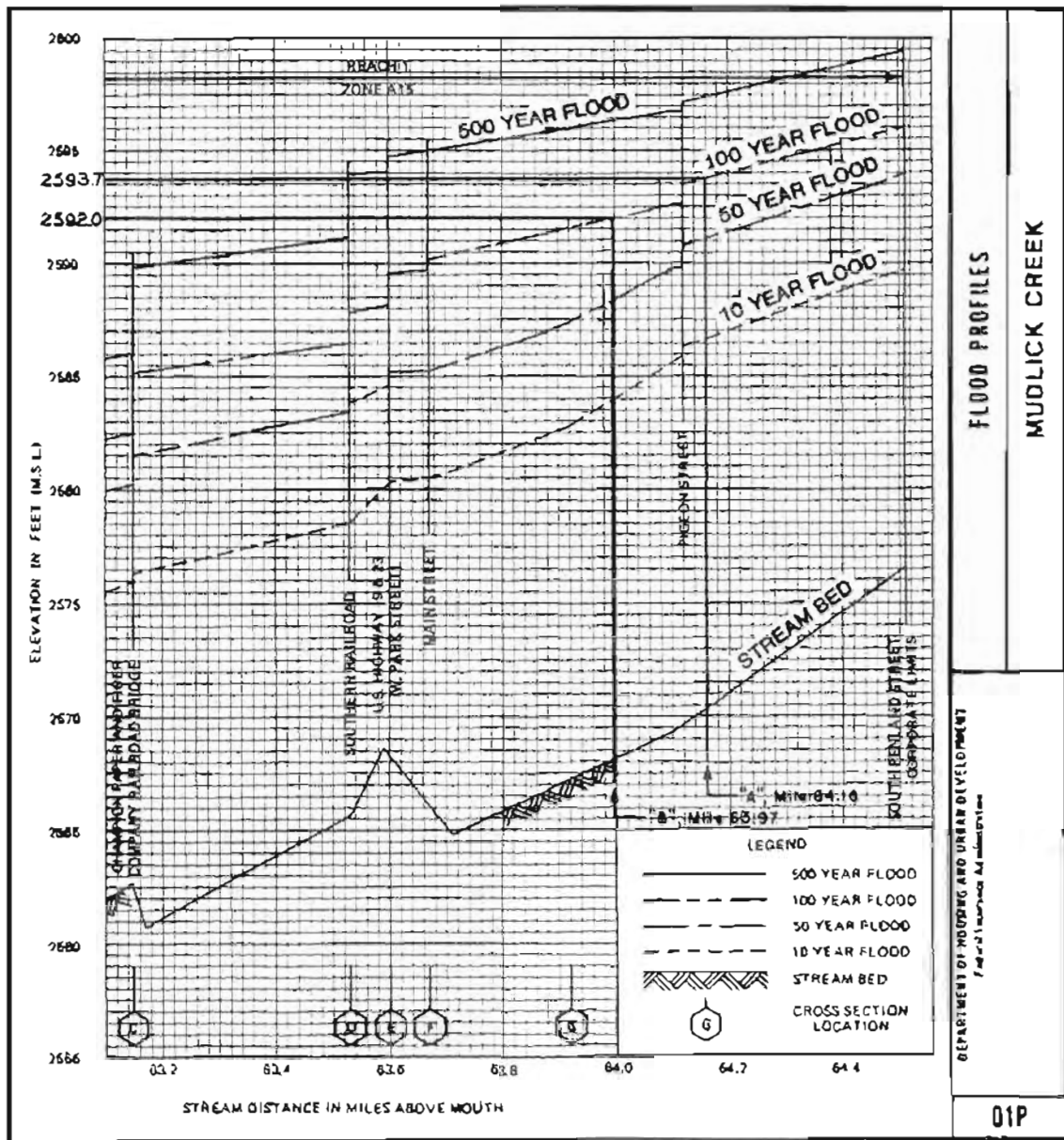
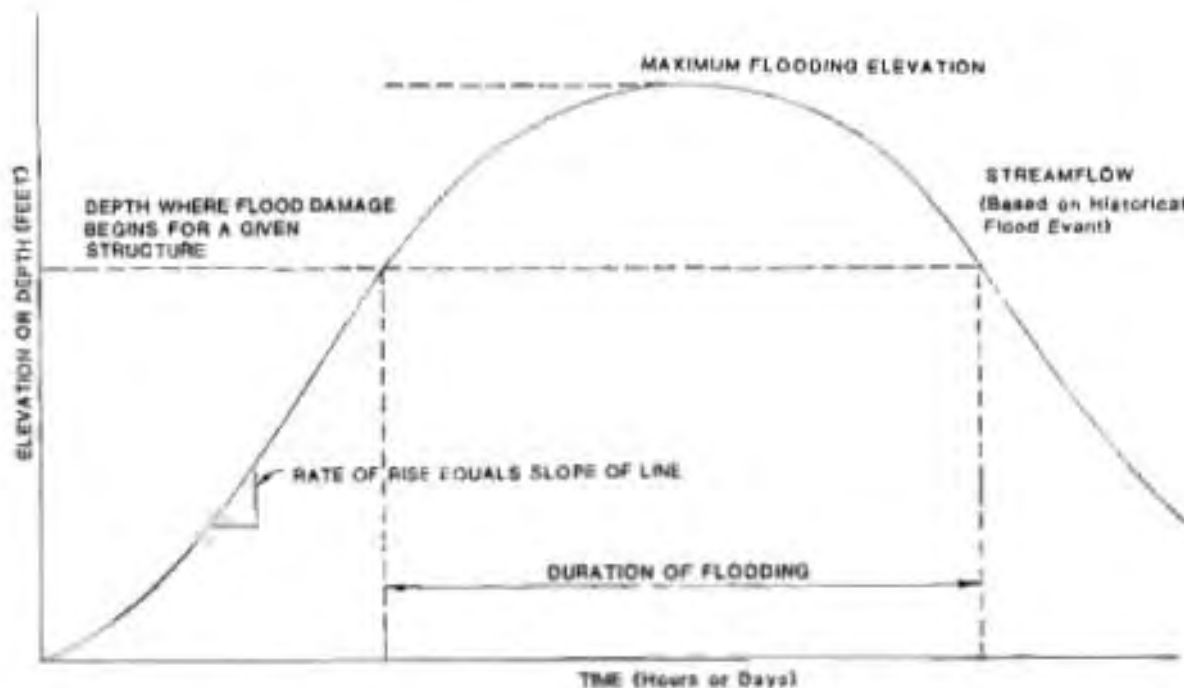

Figure II-7. Typical Flood Profile

4. RATE OF RISE. The rate of rise of a flood is an expression of how rapidly water depth increases during a flooding event. This factor is important when determining whether sufficient lead time is available to permit the use of contingent floodproofing methods; and for designing appropriate emergency evacuation plans. The rate of rise of floodwaters can be derived from a streamflow hydrograph for the area under consideration that relates flooding depth to time (see Figure II-8). The rate of rise can be determined from the hydrograph by the slope of the hydrograph at the depth and time in question.

Information required to determine rate of rise may be available from existing hydrologic studies, on-site investigations, local civil defense offices, or historical records.

5. DURATION. The duration of a flood is an important floodproofing consideration because it affects the saturation of soils and building materials, seepage rates, and the amount of time facilities might be inaccessible. Floodproofed structures that will be subjected to long periods of flooding must be carefully designed to reduce the risk of failure as a result of soil or building material saturation, internal pump system failures, or similar problems related to extended flood duration. The duration of flooding can be derived from an applicable streamflow hydrograph or, in some cases, from historical flood information. As shown on Figure II-8, the depth at which damage from flooding begins at a particular structure can be plotted on the hydrograph. The amount of time that the water level remains above this elevation indicates the duration of flooding.



*Can be used to determine the rate of rise (amount of advance warning), and the duration of flooding.

Figure II-8. Streamflow Hydrography*

6. FREQUENCY. The frequency of flooding must also be considered in determining the best method for floodproofing a structure. Frequency of flooding is defined as the probability (in percent) that a random flood event will equal or exceed a specified magnitude in a given time period, usually one year. The frequency of flooding can be statistically determined using historical records of flooding at the location under consideration.

The owner of a structure subject to a high frequency of flooding may choose to install permanent floodproofing measures instead of contingent measures to reduce operational costs and the chance for system failure resulting from an inadequate response.

D. SITE FACTORS

In addition to the collection of information that defines the extent and characteristics of floodwaters, there are several other site specific features that must be investigated as part of a pre-design analysis of floodproofing alternatives. The designer must identify floodproofing constraints and opportunities associated with geologic, ground water, and soil conditions, existing infrastructure, and physiographic characteristics of the project area.

1. GEOLOGY, GROUND WATER, AND SOIL CONDITIONS. The selection and design of most floodproofing measures requires an evaluation of geologic, groundwater, and soil conditions. Although geologic features do not generally represent a key design factor in floodproofing design, basic data should be collected to identify any major geologic constraints including presence of Karst (sink-hole) features, faults, or extremely shallow depth to bedrock. Likewise, the depth of the groundwater table in the area should be determined because a high water table in combination with flooding conditions could have a significant impact on foundation and floor system design.

Soil characteristics will often have a major effect on the selection and performance of floodproofing systems. Factors that are of primary importance include permeability, erosion potential, slope stability,

and bearing capacity. Soil characteristics are particularly important in determining the feasibility of elevating structures on fill material, the construction of earth berm levees, and foundation design for floodwalls and elevated structures. General soil characteristics can be determined by referring to Soil Survey Reports published by the U. S. Department of Agriculture's Soil Conservation Service. However, final floodproofing design must be based on site specific detailed soil analyses conducted by a qualified soils engineer.

2. INFRASTRUCTURE. Existing road and utility systems can influence the selection and design of various floodproofing measures. For example, levees and floodwalls must be compatible with road, rail or water-borne transportation systems; and elevated facilities must be designed so that they are accessible to people and materials. In addition, the floodproofed facility must be designed so that it is compatible with existing utility systems. Information concerning existing and planned road and utility systems that may influence floodproofing design may be obtained from local and state planning agencies and utility companies.

3. PHYSIOGRAPHIC CHARACTERISTICS. An analysis of the various physiographic features of a proposed floodproofing site is an important step in the identification of the best location for a new building or the location of a floodwall or levee. Characteristics that should be considered include the size and shape of the land parcel, site elevations, slope, and existing drainage patterns. The physiographic characteristics of an area may have a significant impact on the feasibility of floodproofing systems that require a substantial amount of space, such as levees and fill used to elevate a structure. In addition, levees and earth fills must be carefully designed so that they do not create a significant constriction of flood flows, thereby increasing hazards for other facilities in the area. Physiographic features can be determined from topographic maps, floodplain studies, and on-site investigations.

E. FUNCTIONAL, OPERATIONAL, AND ECONOMIC FACTORS

Viable floodproofing alternatives must be responsive to the functional usage requirements of the structure, the safety of the structure's occupants, and the reactions of local officials and citizens to the proposed measures. In addition, the ultimate test of feasibility lies in the relative cost of the measure weighed against the economic benefits to be gained by taking action.

1. USAGE REQUIREMENTS. The functions that must take place in a non-residential building can have a major impact on the types of floodproofing measures which may be used. For example, if a doorway must be used for delivery of freight or personnel access, it is obviously not feasible to permanently close that opening. Likewise, critical facilities such as hospitals or fire stations cannot function properly if access is restricted by floodwalls or some other floodproofing technique. The current and future use of the structure must be carefully evaluated in deciding to what degree access can be limited and in determining how long the facility can be closed during a flood and how well the effects of the design flood being exceeded can be tolerated.

2. SAFETY. The relationship of various floodproofing options to occupant safety must be evaluated in the pre-design phase. In situations where a floodproofed facility is likely to be completely surrounded by floodwaters, provisions must be made for the evacuation of all personnel and residents before flooding affects the structure. Evacuation is essential because it is always possible that a flood may exceed the design capacity of the floodproofing measures, which could result in extreme danger to any occupants that remain at the site.

Federal Executive Order 11988 on Floodplain Management requires that all federally funded critical service non-residential facilities (such as fire stations, nursing homes and hospitals) be located outside the 500-year floodplain. These facilities should always be restricted to areas that are only exposed to low flood depths and velocities and where access to the site can be assured at all times including peak flooding conditions. These and similar safety requirements

must be carefully evaluated in developing alternative floodproofing plans.

3. FLOOD FORECASTING. As mentioned in preceding sections, contingent and emergency floodproofing methods cannot be successfully implemented without an adequate flood warning and forecasting system. The length of warning time that will be required can vary from a few hours to several days depending upon the complexity of any contingent or emergency techniques that must be implemented. Therefore, flood warnings must be issued promptly and the forecasts must be accurate if they are to be effective. This section provides a brief description of a standard flood forecasting system.

A flood forecasting system must perform two functions: first, it must determine when a flood is imminent, and second, it must predict when specific areas will be flooded. In some cases it may also be necessary to determine when and at what elevation the flood will crest.

For most major streams in the United States, this type of information is provided through the National Weather Service's river forecast centers or its river district offices. (Appendix C provides a listing of these offices.) Unfortunately, many facilities are located on smaller streams not included in a major forecasting network. In these areas, interested property owners can work with appropriate local and state agencies to develop an adequate flood forecasting system.

An organizational structure is required to implement a flood forecasting system. The typical organizational structure that has been used in many parts of the United States includes a flood coordinator, a central staff, observers, and/or a computerized gauge system to collect critical streamflow data. The size of the organization may range from a dozen members to over one hundred based on the size and complexity of the watershed to be monitored. The sequence of activities to be performed by this group during potential flood periods consists of (1) activating the system, (2) reporting observed data, (3) assembling and analyzing the data, (4) developing the forecast, and (5) disseminating the information.

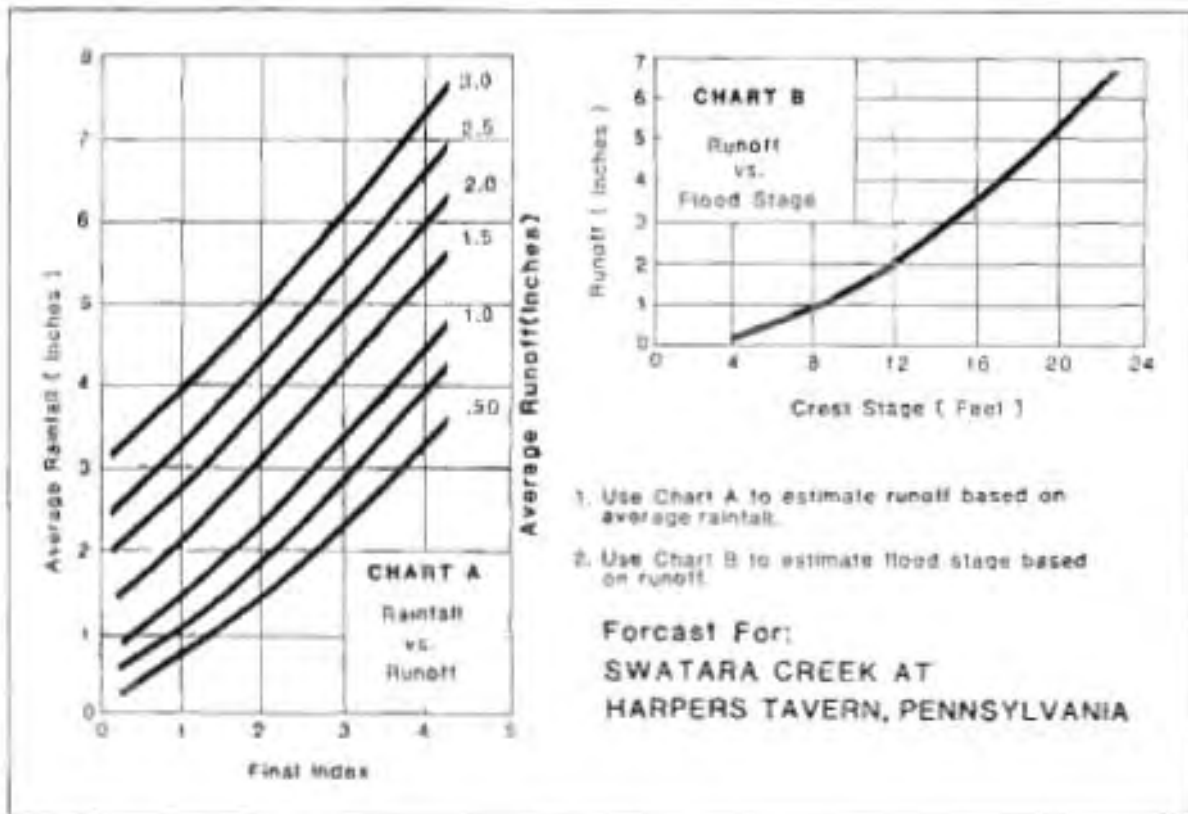

Figure II-9. Flood Forecasting Charts

Source: *Cooperative Flood Loss Reduction*, a technical manual for communities and industry, SEDA-Council of Governments, June 1981.

For a flood forecasting system to be effective, it must begin functioning immediately when conditions indicate that a flood is imminent. The system may be activated in one of two ways. First, it may be activated by the flood coordinator. The person designated for this role should always know when conditions are favorable for the development of floods. This information can be obtained from the National Weather Service or through private meteorological agencies. The flood coordinator should closely monitor the development of such conditions and activate the system as soon as it is determined that flood-producing events may occur. The system could also be activated by an observer or automatic gauge system when a predetermined stream level or amount of rainfall occurs.

Activation of the system requires the flood coordinator and the central staff to report to a

prearranged location and that the system's observers, if any, begin to record and report data on a regular basis. The central staff should immediately begin to assemble and to analyze information being reported from the observers and/or automatic gauges. The method of reporting this information must be highly reliable because the accuracy of all predictions will be based on the receipt of correct and timely data.

Data analysis is normally performed by hand, using charts that have been prepared for the area. These charts are usually designed to use the average precipitation over the drainage area to develop an estimate of runoff amount (see Figure II-9). This runoff amount is then multiplied by a correction factor that is designed to adjust for antecedent moisture conditions, ground cover type, and other factors. This final step allows the forecasters to estimate the net magnitude of flood runoff, which can

then be used to estimate anticipated flood elevations, rate of rise, and duration of flooding. The National Weather Service can provide assistance required to prepare these charts, or input data may be obtained from historical information (where accurate information exists) or from computer simulations of the watershed. Because it is very important that flood forecasts be as accurate as possible, the forecasting charts should be updated and modified after every flood event. The flood coordinator is generally responsible for deciding that specific areas are likely to be flooded, and for issuing a flood warning when appropriate.

4. PREPAREDNESS PLANS. Proper design of floodproofing measures for a facility, and provision of the necessary equipment and floodproofing devices represent important components of a successful floodproofing program. However, these actions alone cannot ensure success. It is still necessary for all measures to be properly installed within the limited amount of time that is available prior to flooding. The best means of ensuring that this can be done is through the preparation and implementation of a flood emergency preparedness plan.

A preparedness plan must be comprehensive and specific. The plan must cover every aspect of the floodproofing procedure ranging from the initial receipt of a flood warning to post flood cleanup requirements. Each activity must be clearly specified in its order of occurrence, with enough detail to ensure that the personnel who will be required to perform these activities will know exactly what to do and how to do it. Each task must be specifically assigned to an individual or group to minimize confusion and duplication of efforts.

The first item that the flood emergency preparedness plan must consider generally involves the evacuation of all personnel except those required to install the floodproofing measures. For those times when the structure is not occupied, the plan should include provisions for the efficient notification and assembly of personnel that are responsible for initiating all contingent and emergency floodproofing measures.

The plan must also recognize that many vital services to the facility may be disrupted during a flood. For example, if communications and electrical service must be maintained to install the floodproofing elements and to run critical equipment during the flood, it may be necessary to provide a supplemental radio system and portable electrical generators.

Hazards to persons and property on and off the site must also be identified and resolved in the preparedness plan. When flooding occurs on the site, several potential hazards may exist such as electrical wiring in or near standing water or ruptured gas lines or tanks. In addition, emergency personnel working at the site could be stranded without provisions, utilities, or water. Off site hazards might include hazardous substance spills resulting from broken fuel lines or small buildings or tanks that could float off the site and damage other property. The plan must identify these types of hazards and identify appropriate safety measures that will reduce these risks.

Two final items that the flood preparedness plan should cover are maintenance and training. The preparedness plan should include a checklist of maintenance items to be performed regularly. A completed checklist verifying that all items were inspected during specified time intervals should be maintained as part of the facility's permanent records. A regular training program should be established to ensure that those who are responsible for various steps in the floodproofing procedure can perform their tasks efficiently.



Back-up personnel should also be assigned to key positions and participate in the training program so that an adequate number of qualified personnel can be obtained at any time. The training program should include actual installations of various measures as part of impromptu preparedness drills to identify the amount of time that will be required to activate the system and to indicate problems which might occur.

In summary, the flood emergency preparedness plan should define all of the steps involved in implementing floodproofing procedures at a facility and give a thorough explanation of how each step is to be performed. In addition, the plan should anticipate any problem that might arise during the floodproofing of the structure and develop solutions to those problems. Finally, the plan should provide for regular maintenance of all floodproofing elements and auxiliary equipment and should establish a permanent training program for personnel involved in implementing the floodproofing measures.

5. ECONOMIC FEASIBILITY. Once it has been determined that floodproofing is feasible in terms of regulatory requirements and the physical characteristics of the floodplain and the structure, it is possible to identify the floodproofing program that is most cost effective. A cost effective plan would be one where the total cost of floodproofing (installation, operation, and maintenance) is less than the amount of physical flood damages, lost earnings, and other economic impacts that are likely to occur if the structure is not floodproofed.

Damages are generally calculated on an average annual damage basis over the economic life of the structure. These average annual damages that would be incurred without floodproofing are then viewed as the average annual benefits associated with the proposed floodproofing plan. Other benefits, such as reductions in flood insurance premiums, reduction in lost production time, or the advantageous use of the space beneath an elevated structure should also be included in the calculation of annual benefits.

The total cost of implementing a floodproofing plan must also be calculated. All factors must be considered, including the cost of installation,

operation, maintenance, financing, training, installation of contingent methods, and the cost of maintaining an adequate warning system. Once these variables have been identified, it is possible to amortize the total project cost over the economic life of the structure to identify an average annual cost. The average annual cost can then be directly compared with the average annual benefits (damages prevented) to determine the relative cost effectiveness of proposed floodproofing plans. Chapter V provides more detailed guidelines that can be used to estimate the costs and benefits of specific floodproofing plans.

If public opinion is not considered in the preparation of floodproofing plans, it is possible that a technically sound and cost effective program can be jeopardized. Therefore, a coordination program should be considered during the initial stages of the project to ensure program success.



F. STRUCTURE CHARACTERISTICS

The physical characteristics of a structure must also be carefully evaluated to determine appropriate floodproofing applications. For existing structures, it is important to identify the type and quality of construction techniques that were used and the present structural condition of the facility. With regard to structures that are still in the planning and design stages, it is necessary to identify how alternative designs will contribute to or detract from the ability to minimize future flood damages.

There are an infinite variety of structure types in terms of size, shape, materials, and construction techniques. However, it is possible to identify the most common non-residential building types and to illustrate the general applicability of each type to the floodproofing techniques described in this manual. The reader can refer to Figure II-10 and the following discussion as a general aid in the identification of alternative floodproofing methods that may be applicable for a given structure. These options must then be evaluated in terms of hydrologic and site constraints, functional acceptability, and cost effectiveness based on guidance provided in other sections of this manual.

The matrix illustrated in Figure II-10 begins by making a distinction between structures that have basements and those that do not and between proposed and existing structures. After these distinctions have been made, the reader can refer to the matrix and the following narrative to determine the general applicability of various floodproofing options to particular building types. The following discussion is organized to reflect the three general floodproofing options shown in Figure II-10 including elevation on columns or fill, protection by floodwalls and levees, and floodshield/closure systems.

1. ELEVATION. As indicated by the matrix, elevation of existing buildings is generally limited to structurally sound frame structures with wood or metal siding. In addition, elevation is easiest for existing structures that have a unified floor system that remains intact and can support the structure walls when it is raised from an existing crawl space or basement foundation. This technique is most

applicable to structures that: (1) are small enough to be lifted as a single unit, (2) are light enough to be elevated with standard equipment; and (3) have sufficient space below the first floor to place supporting beams and jacks. Elevation of slab-on-grade structures is possible but more difficult. Elevation of existing masonry, masonry veneer, or concrete structures is also possible. However, elevation of these structure types is generally not cost effective because of the weight of the structures and their general lack of tolerance to the stresses imposed by elevation.

Existing structures that are suitable for elevation may be placed on supporting columns in their present location or they may be physically moved to a new site and placed on a new foundation system or compacted fill. The use of fill material under a structure that is to be elevated in its current location is not feasible because the cost of placing and compacting the fill material under the structure is generally prohibitive. If an existing structure with a basement is elevated, the cost associated with the loss of use of the basement must be considered in the feasibility of this approach.

With regard to new construction, the matrix demonstrates that all structure types may be elevated on columns or fill if this factor is included as an initial design objective.

2. FLOODWALLS AND LEVEES. As shown in Figure II-10, floodwalls and levees could be used to protect virtually any existing or proposed structure regardless of materials, condition, or other structure characteristics. Therefore, the various hydrologic, site, and functional parameters of a particular area must be investigated to determine the feasibility of floodwalls or levees.

GENERAL STRUCTURE TYPE		FLOODPROOFING OPTION			
		ELEVATE ON COLUMNS OR FILL 2	FLOODWALL OR LEVEE	FLOOD SHIELDS & CLOSURES 3	
WITH BASEMENT	PROPOSED STRUCTURE	WOOD OR METAL SIDING	X	O	X
	EXISTING STRUCTURE	MASONRY (CONCRETE BLOCK OR BRICK VENEER)	X	O	O
		CONCRETE (CAST-IN-PLACE OR PRE-CAST)	X	O	O
		WOOD OR METAL SIDING	O	O	X
	EXISTING STRUCTURE	MASONRY (CONCRETE BLOCK OR BRICK VENEER)	X	O	O
		CONCRETE (CAST-IN-PLACE OR PRE-CAST)	X	O	O
WOOD OR METAL SIDING		O	O	X	
WITHOUT BASEMENT	PROPOSED STRUCTURE	MASONRY (CONCRETE BLOCK OR BRICK VENEER)	O	O	O
	EXISTING STRUCTURE	CONCRETE (CAST-IN-PLACE OR PRE-CAST)	O	O	O
		WOOD OR METAL SIDING (WITH UNIFIED FLOOR SYSTEM)	O	O	X
		WOOD OR METAL SIDING (SLAB ON GRADE)	O	O	X
		MASONRY (CONCRETE BLOCK OR BRICK VENEER)	X	O	O
		CONCRETE (CAST-IN-PLACE OR BRICK VENEER)	X	O	O
	O-MAY BE APPLICABLE X-GENERALLY NOT APPLICABLE				

- 1 Table assumes that goal is to prevent water from entering basement (i.e. dry floodproofing)
- 2 Elevation of existing structure on fill may be feasible if structure can be physically moved to a new site that has been properly filled and compacted.
- 3 Flood shields may not be applicable in areas subject to flash flooding conditions; and shields and closures can only be used in structures that have a floor system that can prevent water entry.

Figure II-10. Relationship of Floodproofing Options to Structure Type

3. FLOOD SHIELDS AND CLOSURES.

Assuming flood conditions that reach the first floor elevation of a structure with a basement, and recognizing that the surrounding soil may become saturated, the hydrostatic pressure imposed on the basement walls and floor may exceed the resistance of standard basement construction techniques. This must be considered prior to the use of flood shields and closures to protect existing structures with basements. Flood shields and closures may be used to floodproof new masonry or concrete structures with basements, assuming that the design includes provisions to resist flood forces.

For structures without basements, flood shields and closures may be similarly used when the walls and floor of the facility are impermeable and strong enough to resist loads produced by the design flood. These requirements generally limit the use of flood shields and closures to masonry and concrete structures that are built on a slab-on-grade concrete foundation. Most existing masonry construction is reinforced and its ability to resist extensive hydrostatic forces is usually questionable. Unless construction plans are available indicating reinforced masonry, the walls should be assumed to be reinforced.

Steel or wood frame structures with wood or metal siding are not watertight and have low resistance to flood forces. Therefore, these type of structures are not suitable for flood shields and closures. Other considerations that must be made in the use of floodshields for a structure include the size, location and number of window and door openings to be closed, and the strength of the frames around these openings.



CHAPTER III

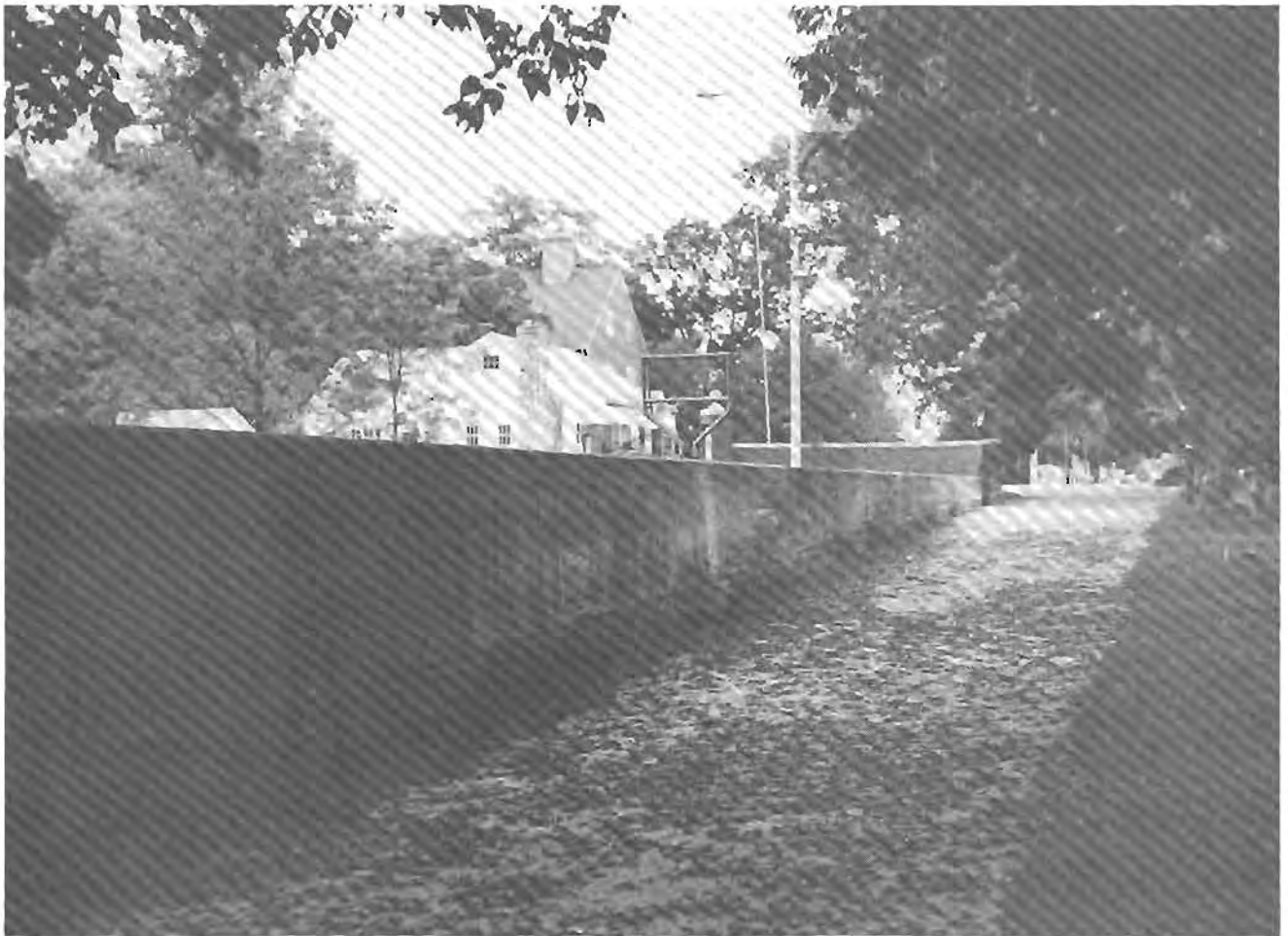

FLOODPROOFING DESIGN PERMANENT AND CONTINGENT MEASURES

A. INTRODUCTION

Based on information contained in Chapters I and II, several alternatives for floodproofing a given structure can be identified. This chapter provides guidelines for the technical evaluation of permanent and contingent floodproofing alternatives and for the assessment of required construction materials. Chapter IV provides similar guidelines for emergency floodproofing measures. Information provided in Chapter V can then be used to develop preliminary cost estimates for floodproofing alternatives.

Many of the design aids in Chapters III and IV are based on general and conservative assumptions. These guidelines are sufficient for preliminary studies, but they are not intended to replace necessary detailed site investigations and professionally prepared construction design documents.

B. ELEVATION ON FILL.

Structures may be placed on elevated fill to protect them from flood damages. Fill placed in a floodplain may, however, cause increased flood heights or velocities. In this case, the potential damage to structures in the area is increased. In particular, fill material cannot be placed within a designated 'floodway' (as specified by the National Flood Insurance Program), unless it can be shown that such placement will not cause a significant increase in flood levels. When placement of fill will not increase flood levels, construction on fill can be a viable flood protection method.

1. FILL STABILITY. Structures on fill may be designed and constructed using standard materials and procedures, however, the effect of soil saturation on foundations may still have to be considered. This potential problem would be applicable for fill areas that are highly permeable and subject to extended periods of flooding. If soil saturation is probable, the foundation support and components of the structure should be designed to withstand all hydrostatic pressures, including uplift forces (see Performance Criteria in Appendix D).



Traditional construction practices can generally be used for the structure itself, with the exception of the case noted above. Therefore, the following presentation is limited to the design of the earth fill. A properly constructed fill may often provide a better building foundation than the original material underlying the fill.

The preliminary design of a fill should include laboratory testing to determine the bearing capacity of the foundation soil and the soil to be used as fill. Soil tests can also establish the potential for long and short term settlement. Well-graded sands and gravels that may contain a small percentage of fine clay materials are the most suitable soil materials for fills used to support buildings. However, most inorganic soils are acceptable with the exception of some of the highly plastic, expanding clays. Cohesionless silts and very fine uniform sands are undesirable because they are very difficult to compact.

To safeguard against excessive settlement, fill should be placed when it is at or near the optimum moisture content for compaction. All vegetation and unstable topsoil must be removed from the area to be filled. The fill should be placed in layers not exceeding 12 inches, and each layer should be compacted with appropriate equipment (i.e., pneumatic rollers, sheepfoot rollers, or vibrating compaction equipment). For most building applications, compaction to 95 percent of the maximum density obtainable with the Standard Proctor Test Method issued by the American Society for Testing and Materials (ASTM Standard D-698) is usually sufficient.

2. FILL DESIGN. After the analyses of the fill material and foundation soils are completed, the design of an earth fill primarily consists of establishing its geometry. In determining the height of fill, some amount of freeboard (margin of safety) may be appropriate between the finished floor and the Design Flood level. The amount of freeboard depends on the incremental damage above the Design Flood level, safety considerations, the incremental cost of fill, and local regulations.

Riprap of the slopes is generally required where the velocity of the stream is greater than 5 feet per

second (fps). A one foot thick layer of riprap with a maximum stone size of 150 pounds is considered adequate for most inland flooding situations. The riprap should have a smooth size distribution with a median rock size of about 25 pounds (eight inch diameter), with 80% of the rocks larger than four inches in diameter and ranging down to gravels.

With a distributed size range, the spaces formed by the larger stones are filled with smaller sizes which prevents the formation of open pockets. Angular stones are more suitable for riprap than rounded stones. The rock should be hard, dense, and durable to withstand long exposure to weathering. Rock should be dumped directly from trucks to minimize segregation of rock sizes.

Vegetation may provide acceptable levels of protection for velocities exceeding 5 fps depending on the type, condition and density of vegetation, and the erosive characteristics of the soil. A more detailed discussion of erosion protection and embankment slope stability is provided in Section E, Item 6, below.

3. FILL MAINTENANCE. Little maintenance is required for elevated fills. Fills in high stream velocity areas may require some repair to the riprap embankment protection. The frequency of repair is a function of the frequency of flooding and the adequacy of the original erosion protection. Some fills may include perforated drain pipe as part of a subdrain system. A well-designed subdrain system needs to be cleaned out once every twenty to thirty years.

C. ELEVATION ON POSTS, PILES, PIERS, OR WALLS

1. GENERAL. In situations where a structure cannot be elevated on fill, the functional floors of the structure may be raised above the Design Flood on supporting posts, piles, piers or walls. This solution is particularly appropriate where fill material is not available, where the space below the elevated structure can be used for a secondary purpose such as parking, or where fill cannot be used due to flood characteristics.

Elevated building support systems may be constructed of a variety of materials including wood, steel, masonry, and concrete. Concrete and masonry systems are generally considered most durable under all environmental conditions; but steel and wood will perform satisfactorily if these materials are protected from the elements. Local construction practice and the intended function of the elevated structure will generally indicate the most economical and suitable building material for a particular area.

Whatever materials are used, the elevated structure must be capable of meeting the performance criteria provided in Appendix D. The support system must be designed to minimize the effects of floodwater forces from moving water, debris, impact forces, and accumulation of flood debris without compromising the strength and stability of the total structure. Special attention should be given to the effect of wind loads in combination with floodwater forces, and to the impact loads that may be exerted on exterior structure supports. It may be necessary to 'over design' the exterior upstream supports of a structure to withstand impact forces if a significant amount of debris will be present. It may also be necessary to add a bracing system to the elevated foundation to withstand all anticipated forces. Ideally, braces should be installed above expected flood levels.

2. POSTS. Light frame structures may be elevated on wood, steel, or concrete 'posts'. Posts are generally installed in pre-dug holes. After the post has been lowered into position, the hole may be backfilled with soil, gravel, crushed rock, or some other loose fill material. The backfilling technique, however, does not generally provide adequate bearing capacity, stability, or uplift resistance for non-residential elevated structures. Because the bearing capacity of a post is primarily derived from its end bearing capacity, the capacity may be increased by enlarging the surface that acts on the underlying soil. Bearing capacity may also be increased by using concrete for a portion or all of the backfill operation as shown in Figure III-1. Total encasement will result in maximum stability and resistance to uplift. As shown in the figure, the posts should be anchored to the concrete backfill to increase uplift resistance.

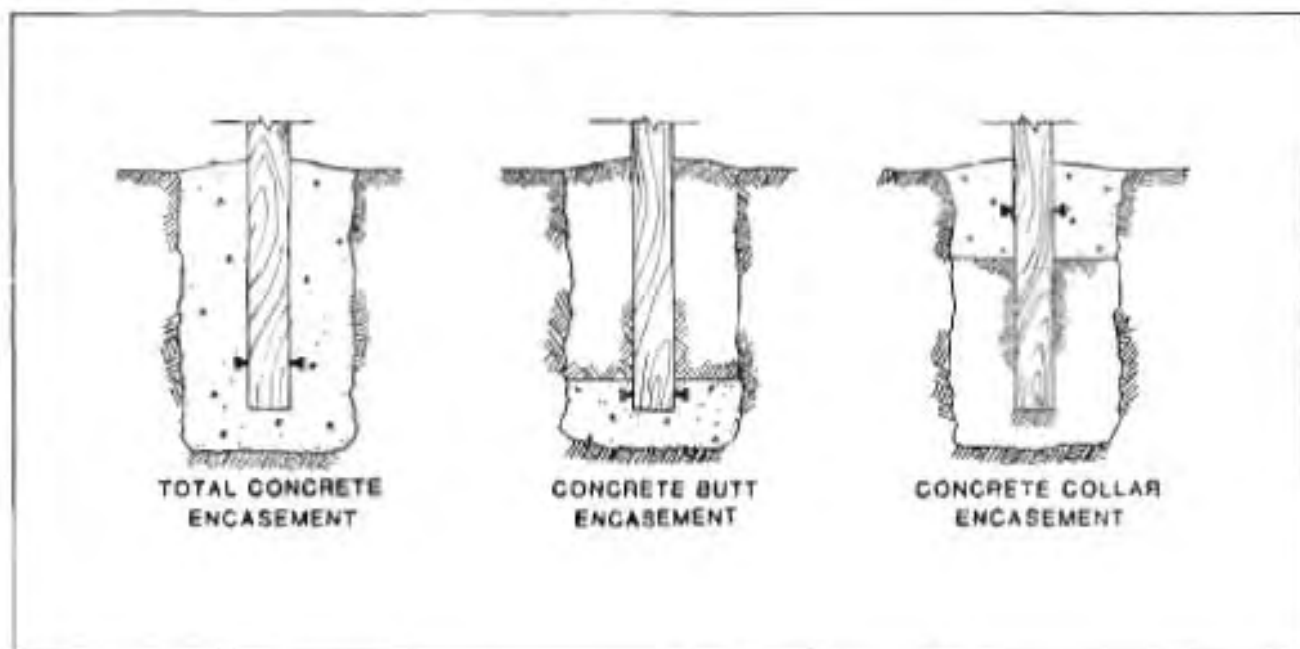

Figure III-1. Concrete Backfill

If poor soil conditions are encountered, the bearing capacity of the post may be improved by the use of a pile or spread footing foundation as shown in Figure III-2. As shown in Figure III-3, the post may be attached above ground level to a reinforced concrete friction pier or a pier that is designed to rest on some other type of footing. If this technique is used it is critical that the post be firmly anchored to the elevated pier to resist overturning and uplift forces.

Posts are generally square or rectangular as these types are easiest to frame into. However, round posts are also used in many cases. As shown by Figure III-4, an elevated structure may be designed to rest on top of the posts (platform construction); or, they may be designed to extend through the structure deck to the roof (pole frame construction) as shown in Figure III-5. Pole frame construction generally increases a structure's resistance to lateral loads.

The number of posts that will be required depends on the diameter and length of the posts, and the amount of load that each column is required to support. Figure III-6 may be used to estimate the approximate size of wood posts after the load per post and the length of the post has been calculated.

Although this nomograph considers only square and rectangular members, round members may be used provided their cross sectional area is equal to or greater than that found in the chart. The nomograph also shows the minimum size post that may be used for a given load and/or a given length.

3. PILES. Piles are slender shafts that are driven to a predetermined design depth (friction pile) or to a stable load bearing strata (hardpan, bedrock, etc.). Piles differ from posts in that piles are driven into the ground whereas posts are set in pre-drilled holes. Pile construction generally results in a much greater degree of strength, stability, and resistance to scour than can be achieved with post construction.

Piles can be placed by driving with a steady succession of blows applied by a drop hammer or compressed-air powered hammer. Piles have also been placed by vibration methods, by the aid of water jets in sandy soils (i.e., displacing the soil at the pile point by using a stream of water under high pressure) and by augering in clayey or silty soils. Longer piles are usually required with the latter two methods, because tamping around the pile is required, and load resistance is less than that achieved with driving.

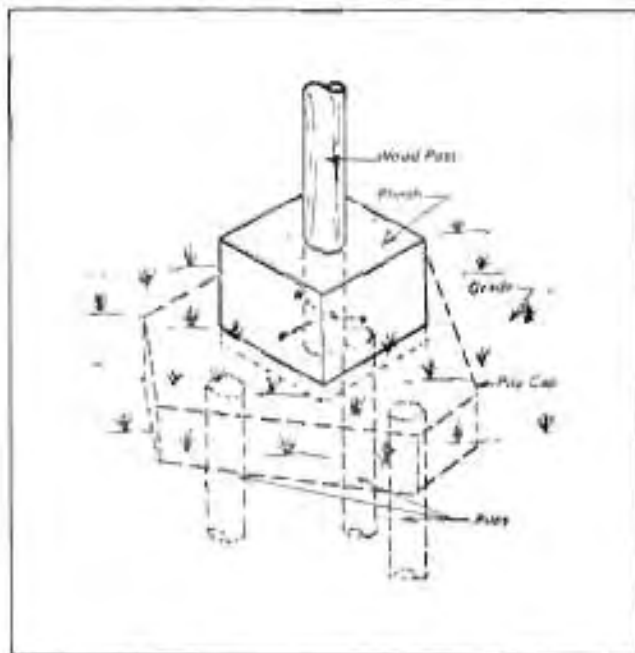

Figure III-2. Pile/Pole Foundation for Low Load Capacity Soils

Source: *Elevated Residential Structures*.

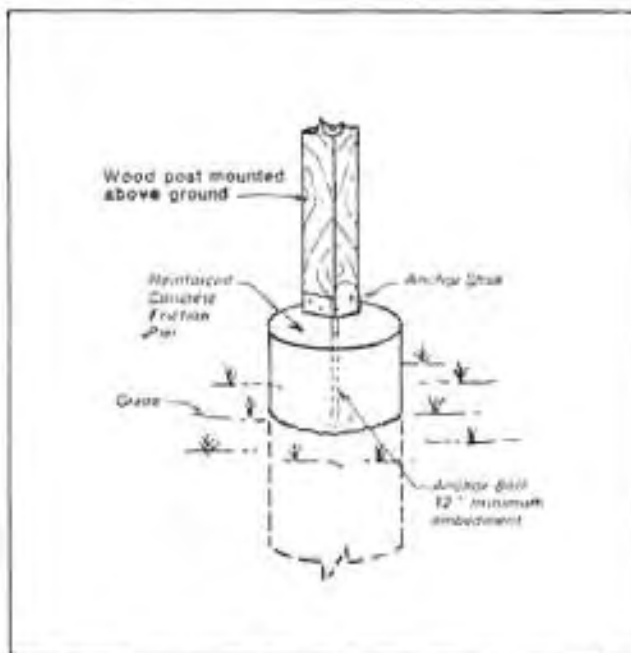

Figure III-3. Reinforced Concrete Friction Pier

Source: *Elevated Residential Structures*

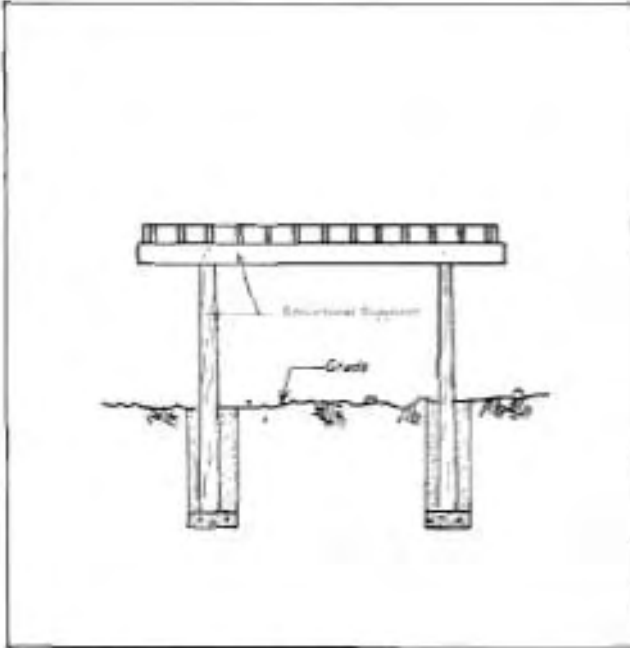

Figure III-4. Platform Construction
Source: *Elevated Residential Structures*

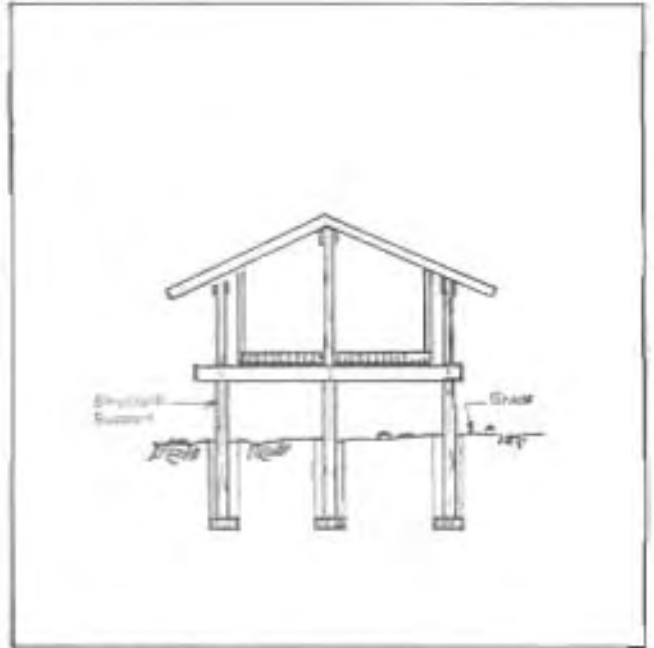

Figure III-5. Pole Framing Construction
Source: *Elevated Residential Structures*



Pre-1970 lumber sizes
Lumber dried below 19%
No. 1 Southern Pine, Douglas Fir or equiv.

Examples:

- 14,000 lbs, 8' length: 4x6 needed
- 24,000 lbs, 5' length: 4x6 needed (load exceeds max for 4x4, List B)
- 3,000 lbs, 20' length: 6x6 needed (length exceeds max for 4" thick columns, List D)

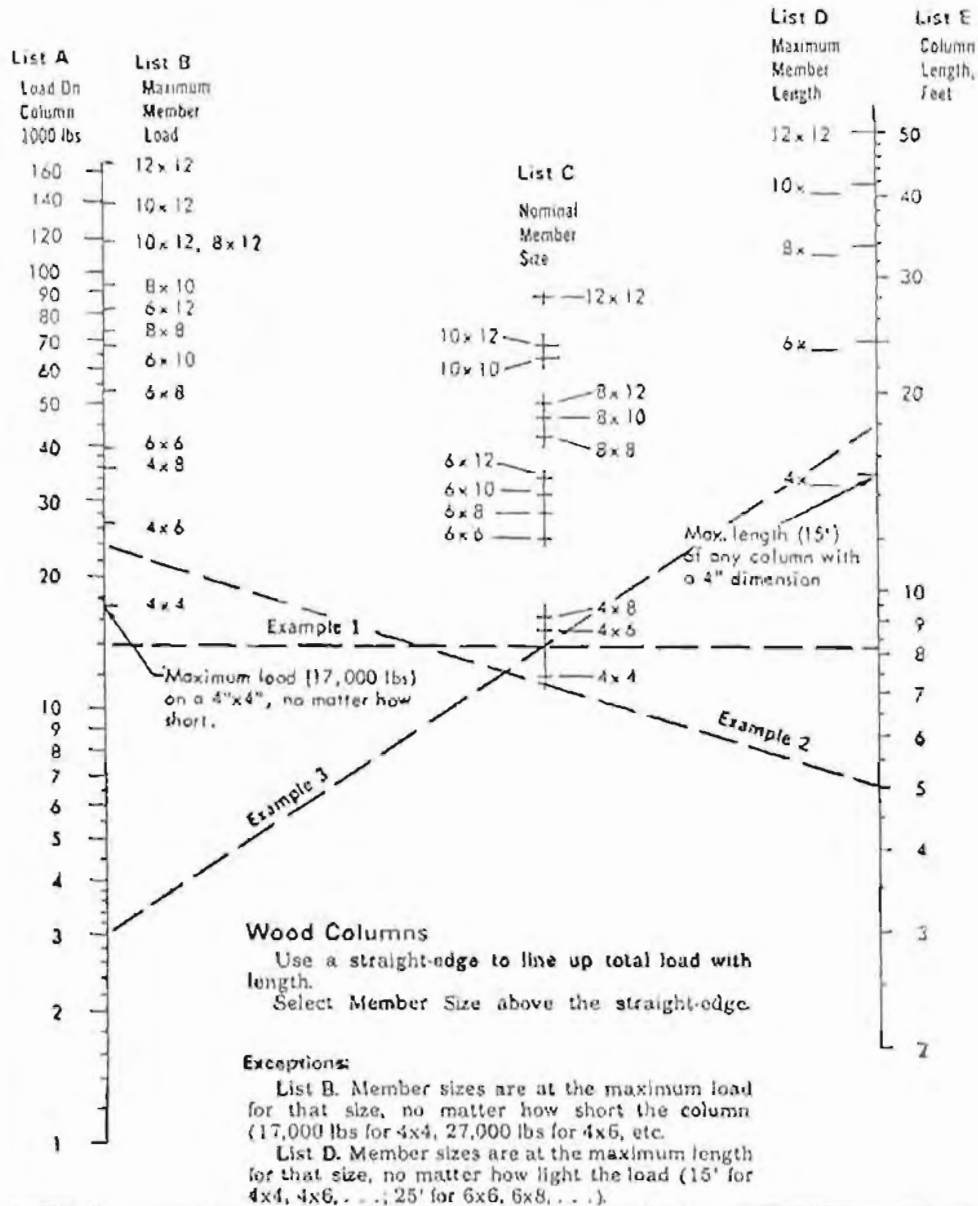

Figure III-6. Approximate Loads on Wood Posts

Source: Timber Construction Manual American Institute of Timber Construction

Piles transmit surface loads to the lower levels in the soil mass through a complex soil structure interaction. This load transfer is commonly accomplished by soil-pile friction, pile-tip bearing, or a combination of the two methods. Actual soil conditions will govern the number of piles required to support a given load and the depth of embedment.

The use of timber piles is somewhat restricted by the hardness of the receiving material. Damage to the ends of timber piles may be reduced by using a steel tip or shoe, however it is still possible to break a timber pile under hard driving conditions. For these reasons, timber piles are generally limited to applications where the maximum load will not exceed 30 tons per pile. Southern yellow pine, Douglas fir, and oak are among the principal species used for piling. On the other end of the strength scale, open-end concrete-filled pipe piles are capable of withstanding maximum single pile loads of up to 250 tons.

Piles may also be driven to or below ground level to provide a foundation for posts or piers, or they may extend out of the ground to a level that is at or near the Design Flood and used to support the structure floor (see Figure III-4, Platform Framing). Although piles may be designed to extend to the roof line of a structure (exterior framing construction as shown by Figure III-5) this procedure is generally more difficult because of problems encountered in maintaining precise alignment of the pile as it is driven.

The number of piles that will be required to carry a given load will generally be determined by the ability of the piles to transmit their load to the soil or bearing strata. Pile size and strength is important in resisting lateral loads from wind and floods. Figure III-7 summarizes typical characteristics of timber, steel, and concrete piles.

4. PIERS AND WALLS. Structures may also be elevated on a system of piers and/or wall components. Piers are essentially heavy columns that are constructed out of brick, masonry block, or cast-in-place concrete. Supporting walls may be constructed from these same materials.





	PILE TYPE		
	TIMBER	STEEL	CLOSED-END PIPE CAST-IN-PLACE CONCRETE
General Working Length	30-60 ft	40-160 ft.	30-80 ft.
Maximum Design Load Per Pile: Piles on Rock Friction Pile	25 tons 30 tons	150 tons 60 tons	120 tons 60 tons
Application	Best suited for friction pile in granular material	Best suited for end bearing on rock or where extreme depths are required to develop adequate friction	Best suited for medium length friction piles
Advantages	Low initial cost Ease of handling	Easy to splice High Capacity Small Displacement	Can be redriven Shells not easily damaged
Disadvantages	Difficult to splice Vulnerable to damage in hard driving Vulnerable to decay	Vulnerable to Corrosion Easily damaged or deflected by major obstructions	Considerable Displacement Hard to splice after concrete has been placed
Typical Elevation			
Typical Cross Section	 Cross Section	 Typical cross sections Rails or Sheetpile sections can be used as shown below Welded Rail Welded Sheetpile	 12 to 24 dia. Typical cross section (fluted shell) 16 to 36 dia. Sheet thickness 1/8 to 1/4 Typical cross section (Spiral welded shell)

Figure III-7. Typical Pile Characteristics

Source: Adapted from Foundation Analysis & Design by Joseph E. Bowles

Piers constructed of brick (Figure III-8) or concrete masonry block (Figure III-9) must be anchored to an appropriate footing and voids must be filled with concrete and reinforced as required to withstand anticipated loading conditions. The minimum size of brick or reinforced masonry block pier is recommended to be 12" X 12". Masonry piers should be limited in height to a maximum of ten times their smallest dimension.

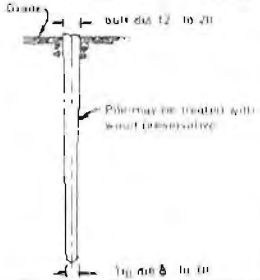
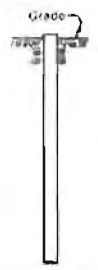
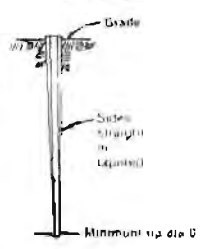
Cast-in-place concrete piers (see Figure III-10) can be either reinforced or non-reinforced. High lateral loading conditions will require reinforcing. The recommended minimum size of a cast-in-place concrete pier is 10" X 10", or 12" in diameter.

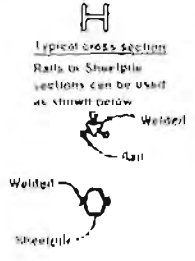
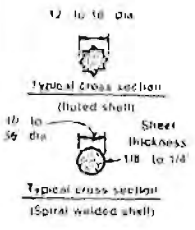
In cases where extreme loading conditions exist and floodwater velocities are low to moderate, additional strength may be obtained by using pier (shear) wall sections. These walls should be constructed of cast-in-place concrete or reinforced

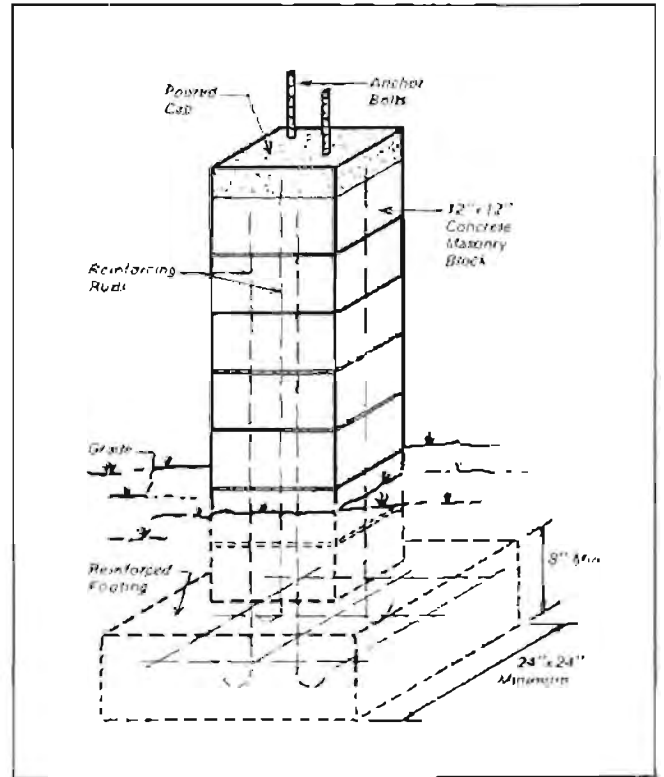

Figure III-9. Reinforced Concrete Masonry Pier
Source: *Elevated Residential Structures*

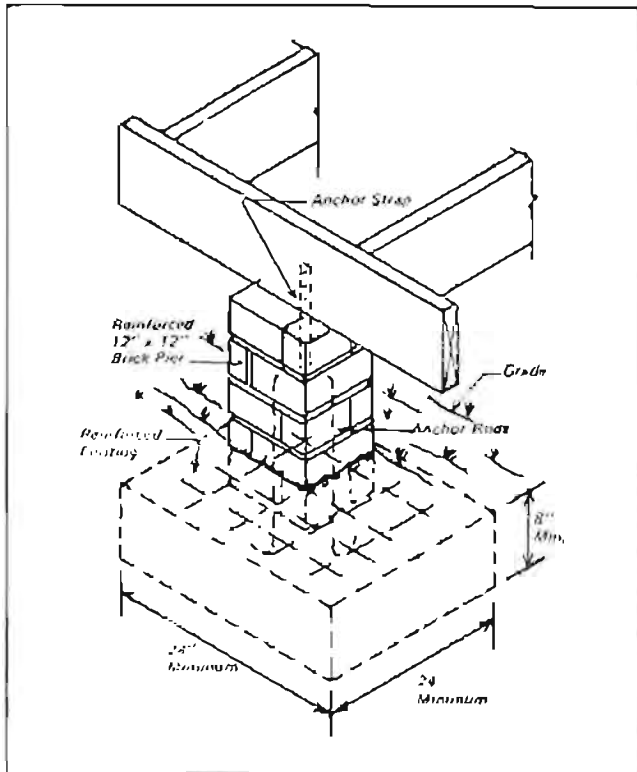

Figure III-8. Brick Pier
Source: *Elevated Residential Structures*

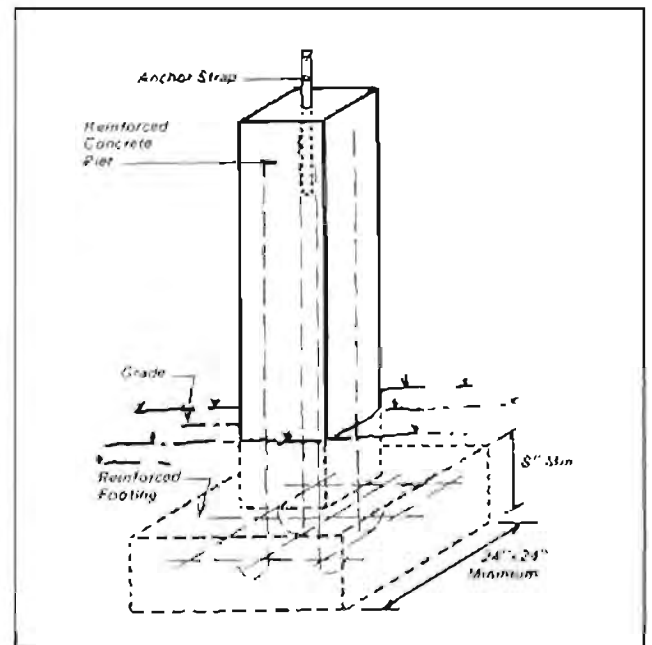

Figure III-10. Reinforced Concrete Pier
Source: *Elevated Residential Structures*

masonry. Wall sections should be placed parallel to the direction of flood flow as shown in Figure III-11, and should be spaced to provide the least obstruction to flow and the least potential for trapping floating debris. Shear wall sections may also be attached to posts or piles in the above manner to increase the lateral stability of the post or pile system.

Piers may be supported on isolated spread footings (Figure III-11) or a deep pile foundation (Figure III-2). The bottom of the footing should be placed below the local extreme frost penetration level and at a depth that is capable of resisting anticipated lateral, uplift, and scour forces. Table III-1 summarizes some of the major requirements for reinforced pier construction.

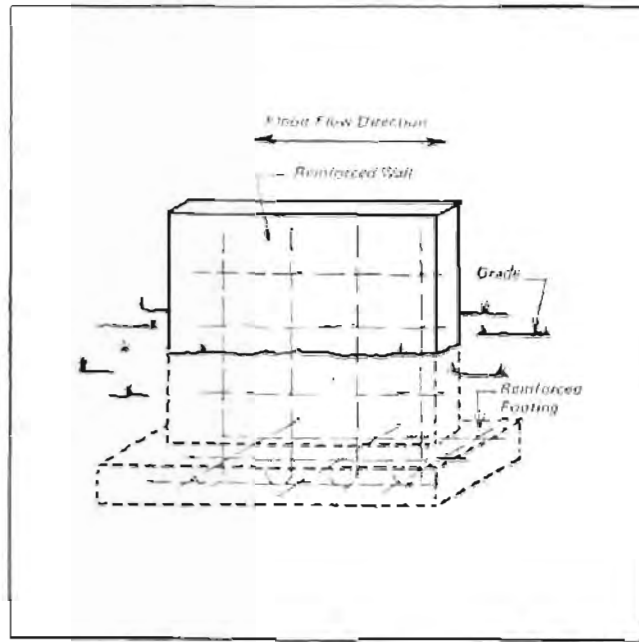

Figure III-11. Reinforced Pier or Solid Wall
Source: *Elevated Residential Structures*

TABLE III-1

MINIMUM REQUIREMENTS FOR REINFORCED PIERS

Pier Material	Min. Pier Size	Min. Footing Size	Pier Spacing		Useful Elevation Range
			Right Angles to Joists	Parallel to Joists	
Brick	12" x 12"	24" x 24" x 8"	8' o.c.	12' o.c.	18" to 6'
Concrete Masonry	12" x 12" or 8" x 16"	24" x 24" x 8" or 20" x 24" x 8"	8' o.c.	12' o.c.	18" to 8'
Poured-in-Place Concrete	Min. 12" dia. or 10" x 10"	20" x 20" x 8"			18" to 12' +

Source: *Elevated Residential Structures*

5. BRACING. Additional lateral support for elevated structures may be provided through the use of knee and diagonal bracing and shear wall bracing.

Knee and diagonal braces (Figure III-12) are bolted to the base of one post or pile and just below or to the floor beams at the adjacent post or pile. Lumber (recommended to be greater than 2 inches thick) or steel rods can be used to brace wood posts or piles. The rods can be fitted through holes filled with wood preservative and fastened with nuts and cast beveled washers. Welded connections or drill holes can be used to provide rod bracing in steel post or pile foundations. Such rods are usually 5/8 to 3/4 inches in diameter. Maintenance requirements for steel bracing are greater due to corrosion. Although diagonal bracing is more likely to be struck by debris than knee bracing, this disadvantage is usually outweighed by the greater stability provided by diagonal bracing.

6. MAINTENANCE. Structures elevated on posts, piles, piers or walls will require more maintenance attention than those elevated on fill. Repair requirements are a function of the frequency of flooding and the adequacy of the original design and construction. If concrete piers are used, maintenance may never be necessary. If steel columns of piers are used, painting will be required at least every three to five years. Timber piers will also require treatment at these intervals. Timber needs to be protected from insect infestations and organic deterioration. Scoured areas around the piers need to be repaired after each flood. The degree of scour repair will be a function of floodwater velocities.

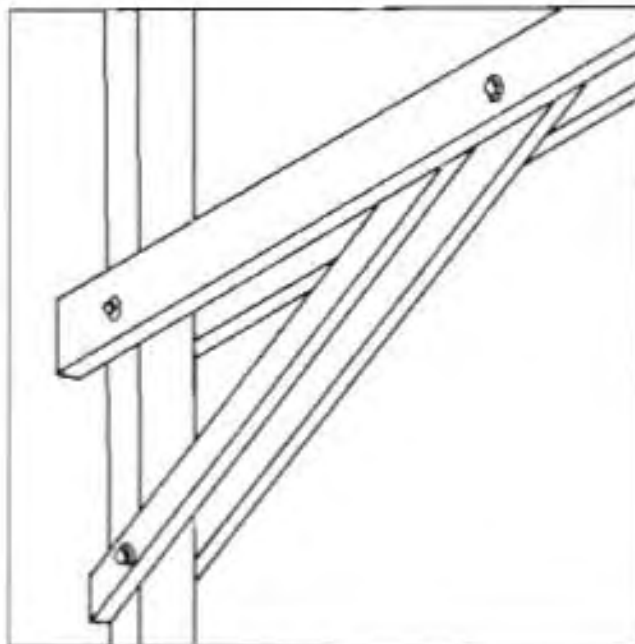

Knee Brace

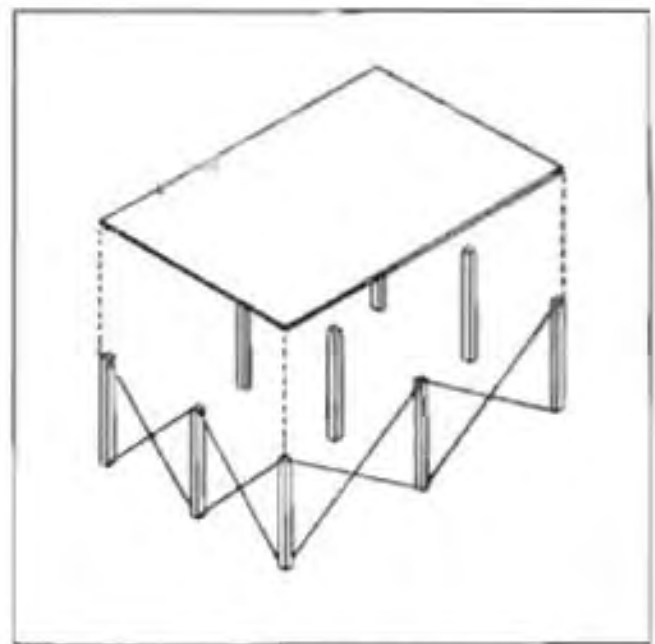

Diagonal Bracing

Figure III-12. Knee and Diagonal Bracing

**D. WATERPROOF CONSTRUCTION
(CLOSURES, FLOOD SHIELDS,
SEALANTS, AND MEMBRANES)**

1. INTRODUCTION. The term "watertight construction" (or, "waterproof construction"), as used in this manual, denotes the floodproofing of a structure to prevent floodwaters from reaching its interior. This approach can result in extreme loading on the exterior surfaces (walls and floor) of a structure. Because of the variety and magnitude of forces that are applied to a watertight structure, all structural components must be carefully analyzed.

Appendix D provides appropriate design criteria. The following sections present structure strength and stability characteristics, waterproofing techniques, closure and flood shield design, and building support systems that must all be evaluated in the design process. The information presented herein may be used to develop initial design concepts. However, the complexity of designing a safe and effective waterproofing system is extremely great. Because of this complexity, final system design must be prepared by an appropriate design professional.

2. WALL STRENGTH. In terms of strength characteristics, there are three basic wall types that may be considered for watertight construction: brick veneer, unreinforced masonry and concrete, and reinforced masonry and concrete.

a) Brick Veneer. Tests have shown that standard brick veneer walls can be used to protect against very low flooding depths. Because the common brick veneer wall leaks excessively, this type of wall must be waterproofed. Best results can be obtained by installing a water barrier between two layers of brick. Without modifications, a standard brick veneer wall should not be expected to withstand more than 2 feet of hydrostatic pressure. If a safety factor is desired, the protection height should be limited to 1.5 feet of water.

b) Unreinforced Masonry and Concrete. Unreinforced concrete and concrete block masonry walls are generally 8 - 12 inches in thickness and contain no vertical or horizontal reinforcement to enhance loading capabilities. These materials are

normally used for structures that are under 24 feet in height. Dead loads for 1-2 story 8" block structures typically range from 500-1500 pounds per linear foot. Dead loads for similar concrete wall structures typically range from 800-2000 pounds per linear foot.

As the vertical load on a wall increases, the water height it can withstand increases. For example, an unreinforced wall 8 feet high and 8 inches thick, subjected to a dead load of 1,000 pounds per linear foot, may withstand water heights up to 3.2 feet, whereas the same wall with a load of 3,000 pounds per linear foot may withstand water heights up to 4 feet. As the height of the wall increases, resistance to failure is lowered.

The *maximum* protection depth for any unreinforced walls, regardless of their thickness, height, or vertical loading characteristics, should be no more than 6 feet. *However, the reader should be cautioned that the strength characteristics as discussed in the paragraph above are based only on lateral forces imposed by non-velocity water loads.* This maximum must also be reduced to allow for forces imposed by soil, impact loads, flood water velocity, etc. For example, floodwater velocity effects on the recommended maximum protection are shown in Figure III-13.

Additional reductions in the protection heights shown in Figure III-13 would be required by soil, impact, and other loads and discussed in Section D, Item 2. *It is necessary that an evaluation of the wall strength capabilities be made by qualified personnel before any watertight protection measures are applied to unreinforced masonry or concrete.*

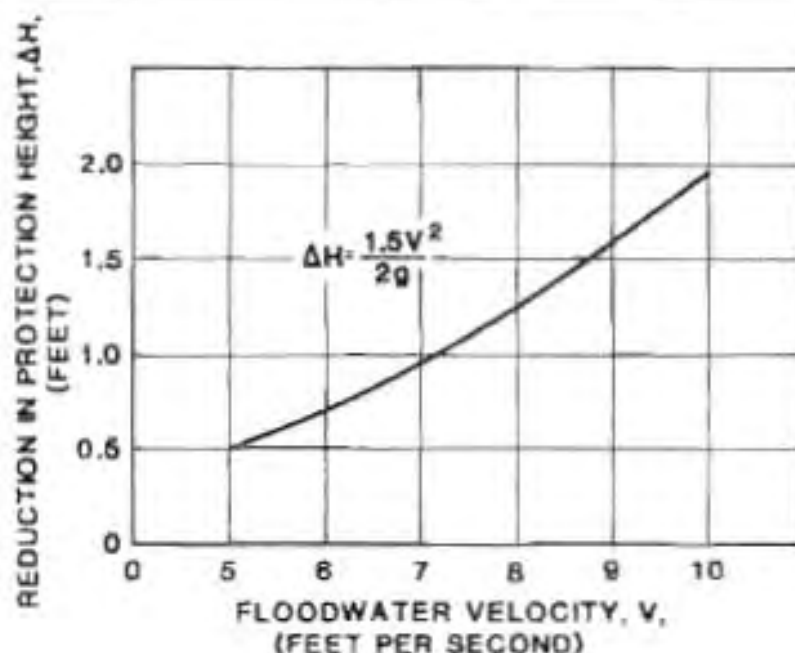

Figure III-13. Reduction in Protection Height as a Function of Floodwater Velocity.

c) **Reinforced Masonry and Concrete.** The design of reinforcement for masonry and concrete walls for commercial and industrial structures cannot be addressed in detail in this manual. The wide range of loading conditions and configurations require that a structural analysis be performed for each design. *Typical re-bar configurations for simple block and concrete walls are given in this section for illustrative purposes only.*

Reinforced masonry walls are generally constructed of 8 or 10 inch thick blocks (Figure III-14). The block units are set in mortar with vertical reinforcing bars grouted into the block cavities. In some cases, horizontal mild steel wire reinforcing is also grouted between every second or third block course, and a block bond beam is often placed on the top course with reinforcing bars. Reinforced cast-in-place concrete walls are also generally 8 - 10 inches thick and are reinforced with vertical mild steel reinforcing bars for bending loads and horizontal temperature and shrinkage steel (Figure III-15). Reinforced wall systems for new structures can be designed to withstand large hydrostatic and

hydrodynamic flood loads. For existing walls, it will be necessary to assume that no reinforcement exists, unless original design plans showing the reinforcement can be found.

d) **Determination of Strength.** The strength of a wall is determined through a series of calculations that require the expertise of a registered engineer. Maximum flood protection depth and flood velocity are factors which need to be determined in addition to consideration of the two common modes of wall failure. The first consideration would be a translation of the bottom of a wall, most probably at the floor line (Shear Failure), driven by an outside horizontal force such as a hydrostatic or a soil force.

The second would be a failure of the block wall somewhere near the mid-height of the wall (Flexural Failure). In determining whether either one of these modes of failure are possible for a given non-reinforced wall, an engineer would calculate the total weight of all of the vertical loads applied to the top of the wall, such as the contributing portion of the weight of the building (i.e., dead loads).

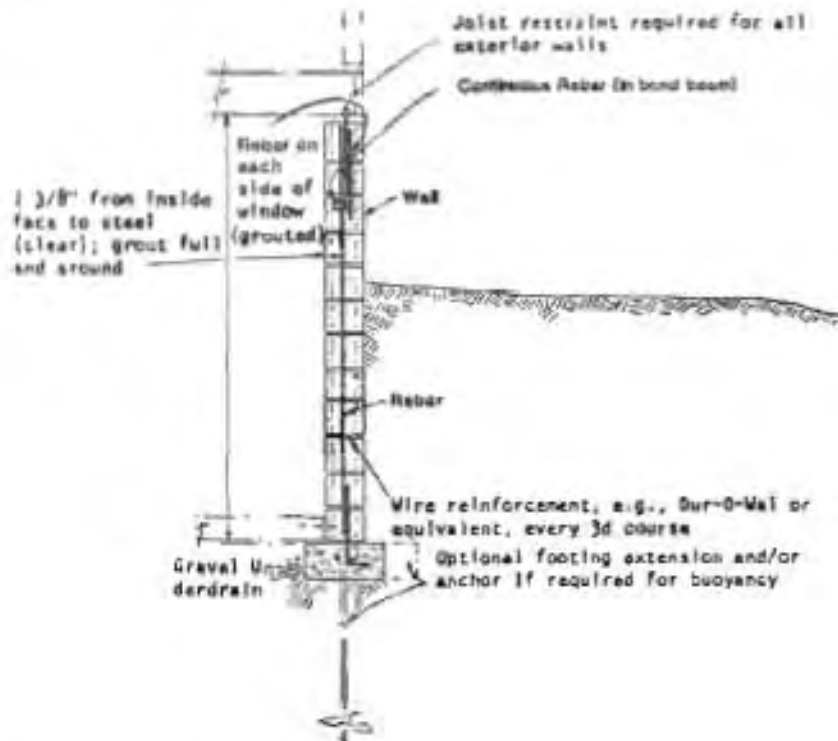

Figure III-14. Typical Reinforced Masonry Block

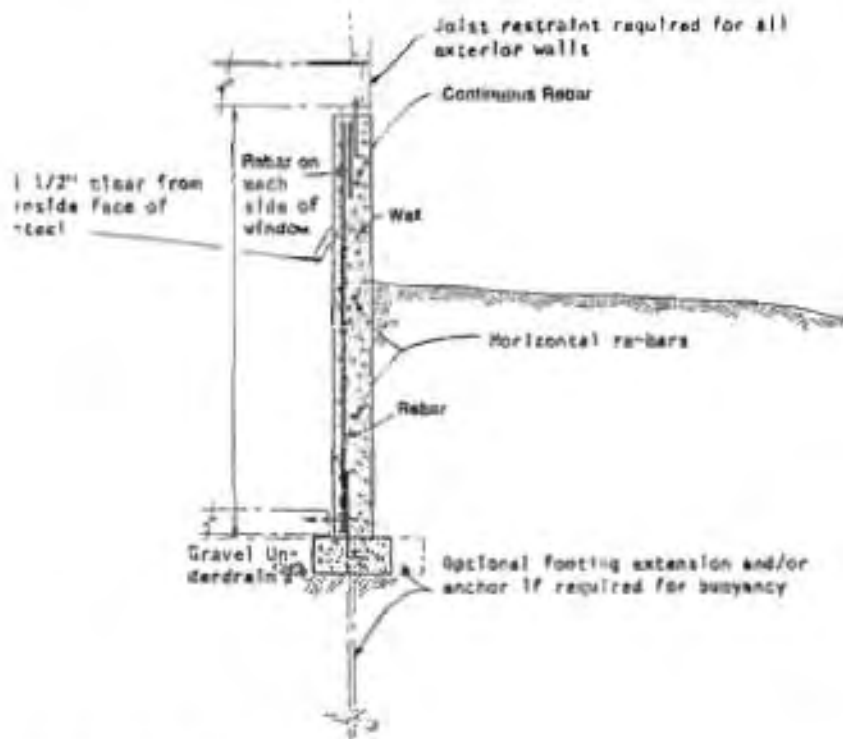

Figure III-15. Typical Reinforced Concrete

One would then sum all of the horizontal loads applied to the wall, such as hydrostatic pressure. The ratio of horizontal to vertical loads is an important parameter in determining the capacity of a wall. The more vertical load the wall is carrying, the more horizontal load it can resist. Knowing the external applied loads, the physical properties of the masonry wall need to be checked. These properties (or variables) include: height, thickness, and tensile and compressive strengths of the mortar and of the block. The relationship of the loads and physical properties are described in other engineering manuals.

The unreinforced wall is usually good for small horizontal hydrostatic pressures such as three feet or less. The usual mode of failure is a tensile failure where the mortar fails in tension. The compressive capacity of mortar is at least 10 times greater than the tensile capacity. Therefore, to offset this deficiency, reinforcing steel bars are grouted into the cells of the masonry block. Once again, the formulas necessary for proportioning the correct amount of steel and where to place it can be found in numerous engineering text books and publications by the Masonry Institute including :

Building Code Requirements for Concrete Masonry Structures (ACI 531-79) & Commentary (ACR 531R-79), American Concrete Institute, 1978.

Masonry Structural Design for Buildings, TM 5-809-3, AFM 88-3, Chap. 3, Departments of the Army and the Air Force, December 1973.

Partially Reinforced Concrete Masonry Walls, National Concrete Masonry Association, 1975.

Reinforced Concrete Masonry Design Tables, National Concrete Masonry Association, 1971.

Reinforced Masonry Design by Robert R. Schneider & Walter L. Dickey, Prentice-Hall Inc., 1980.

The reader should note that the more vertical load a non-reinforced masonry wall is carrying, the more horizontal load it can resist, and reinforcing a masonry wall with steel bars is always a desirable alternative for a plain masonry block wall.

3. FLOOR STRENGTH AND STRUCTURAL STABILITY. Cast-in-place concrete is the only construction material that has the design capability to resist full hydrostatic uplift pressures. Slab floors can resist uplift pressures in two ways. First, an unreinforced slab can be designed to be thick enough to have sufficient strength and dead load to resist the uplift pressures. Unreinforced concrete slabs can withstand a hydrostatic head approximately 2.25 times their thickness above the bottom of the slab. Reliance upon the thickness and weight of the floor slab may be applicable for upgrading the strength and stability of an existing floor system, or for relatively small new structures where the total weight of the proposed structure is not adequate to resist maximum uplift forces. However, this solution is generally not cost-effective.



The second, and preferred technique involves the use of a reinforced concrete slab that is tied into the structure walls, columns, and footings so that the total weight of the structure is used to counteract uplift pressures. This type of construction (see Figure III-16) is generally referred to as a mat or raft foundation. The raft foundation acts as a combined footing that covers the entire area beneath the structure and supports all walls and columns. If the raft is reinforced to resist all applied loads this type of construction provides additional stability and resistance against overturning and flotation forces as a result of the total structural dead and live loading forces on the slab. This technique is generally a very cost-effective way to provide adequate stability for relatively large heavy non-residential structures. Raft construction can also be supported on pile or pier foundations where additional bearing capacity is required.

If detailed analyses show that a structure cannot be stabilized by the slab design techniques described above, it may be possible to reduce uplift pressures or to anchor the structure. These techniques are described in the following sections.

4. COUNTERACTING OF HYDROSTATIC FORCES. In many cases, hydrostatic uplift forces represent a critical loading force that must be reduced if a structure is to be waterproofed successfully. Excessive uplift pressures may be reduced to tolerable levels through the use of impervious blankets and cutoffs, and subsurface drainage systems, and anchorage.

a) Impervious Cutoffs. Various types of impervious cutoffs may be used to decrease the amount of seepage that can flow under a floodproofed structure and to reduce hydrostatic pressures. Cutoffs may be constructed of steel sheet piling, cement grout curtains, impervious compacted soil, or similar materials. The cutoff may be placed directly beneath the foundation footing or it may be placed some distance away from the footing. For new structures, it may be possible to extend the foundation system to connect to an impervious stratum as shown in Figure III-17. This approach is cost-effective only where an appropriate impervious stratum is encountered at a shallow depth. In all cases, when floodwaters are expected to rise above ground level, the cutoff must be designed as an integral part of the

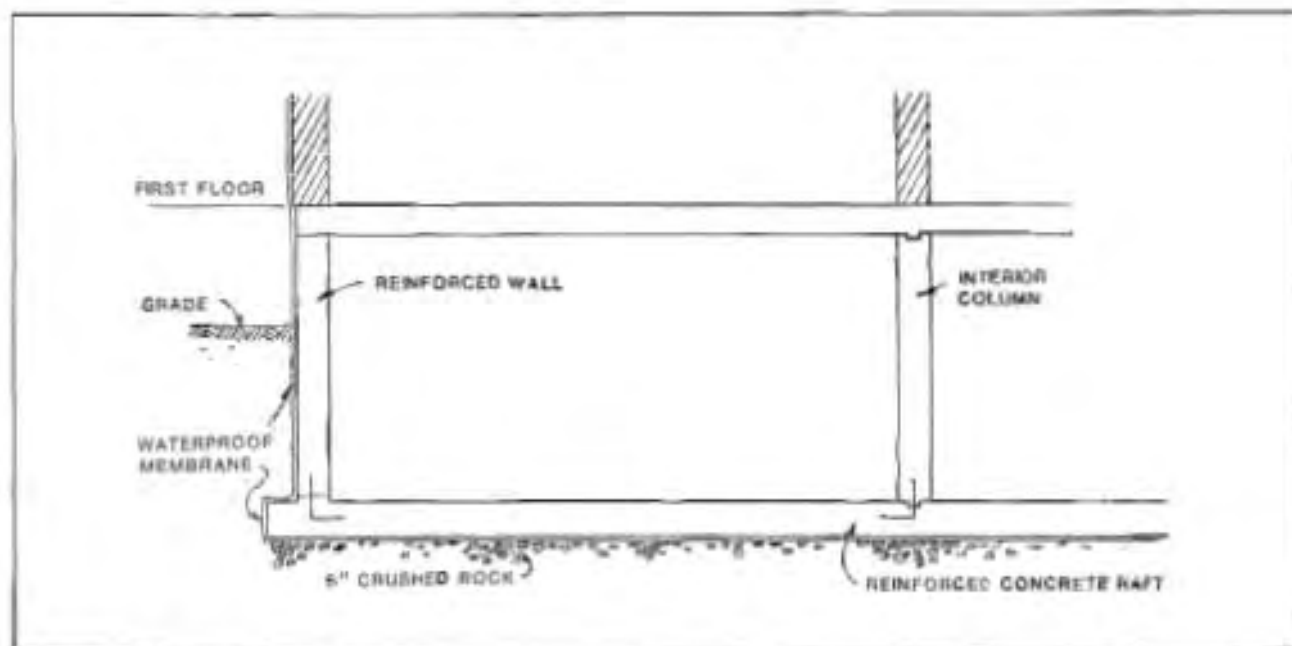

Figure III-16. Raft or Mat Foundation

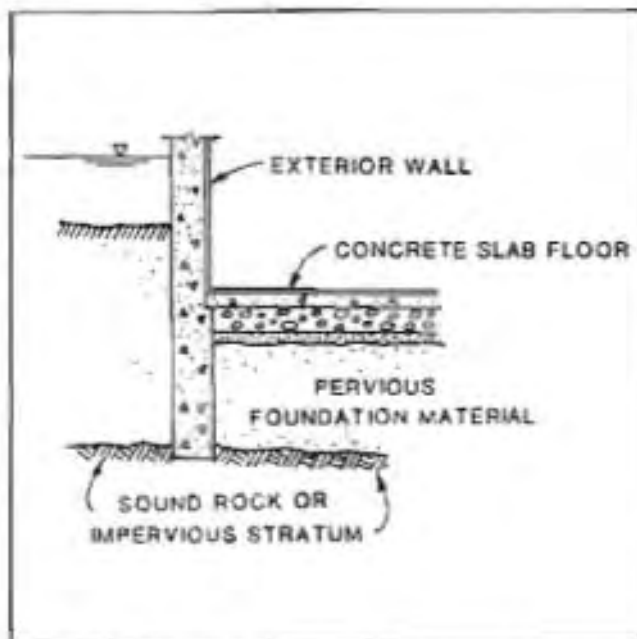

Figure III-17. Wall Extension to Reduce Seepage and Hydrostatic Pressures

structure, or it must be tied into the structure with impervious blankets or membranes as shown in Figure III-18. In addition, the cutoff must extend to an impervious stratum to be effective. Cutoffs, impervious blankets, and membranes must be carefully installed as even a minor defect in the system can result in application of full hydrostatic pressure loading on the foundation wall and floor system.

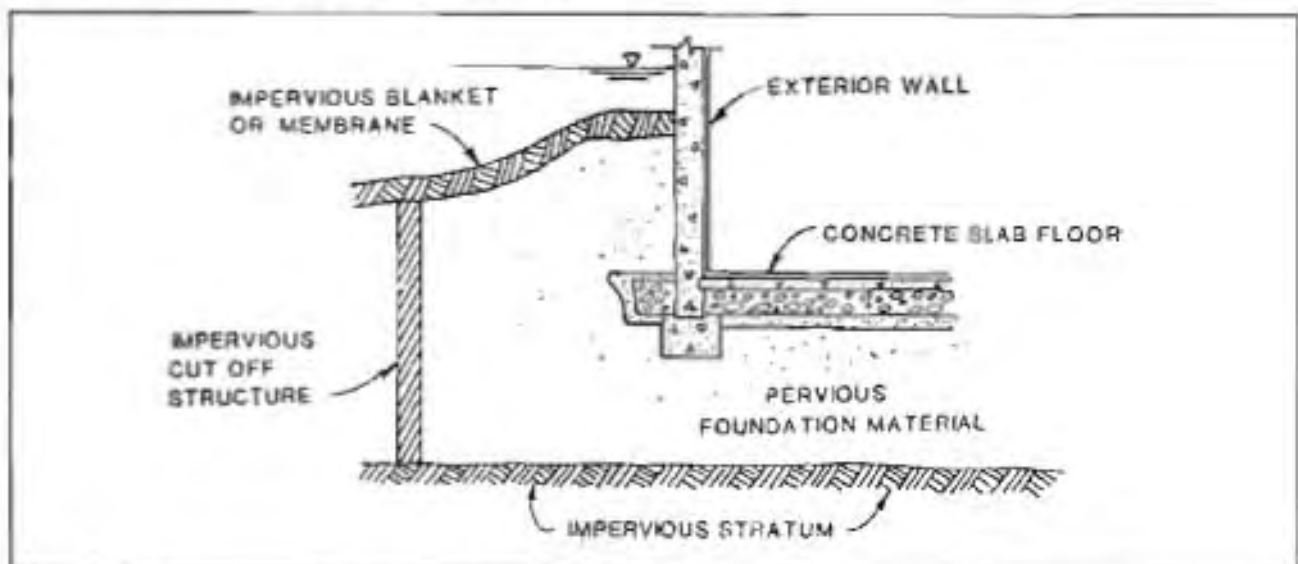

Figure III-18. Impervious Blanket and Cutoff to Reduce Seepage and Hydrostatic Pressures

b) Subsurface Drainage. Subsurface drainage systems may be used alone or in combination with cutoff systems to reduce hydrostatic pressures. Drainage systems are generally not effective in reducing lateral pressures on walls during severe flooding conditions, and even the best foundation drain system is likely to be ineffective when an infinite source of water exists. However, drainage systems can be used to significantly reduce uplift pressures on the floor slab. The degree that pressure can be reduced depends on the permeability of adjacent soils and the adequacy of the subdrainage system design.

The most effective subdrain system requires a blanket drain extending under the total structure foundation as shown in Figure III-19. The blanket drain material must provide adequate bearing capacity while maintaining a high degree of permeability. A system of perforated drain pipes may be used to direct seepage to a sump pump for discharge above the flood level. Provisions for cleaning the drains should be incorporated in the design. The size of the pump (or pumps) required for this purpose will depend on many factors including the permeability of the soil, the length of the seepage path and the depth of flood water exerting pressure on the system. If the pumping system is critical to the stability of the structure, standby equipment must be provided in case the pump fails or the power supply is disrupted.

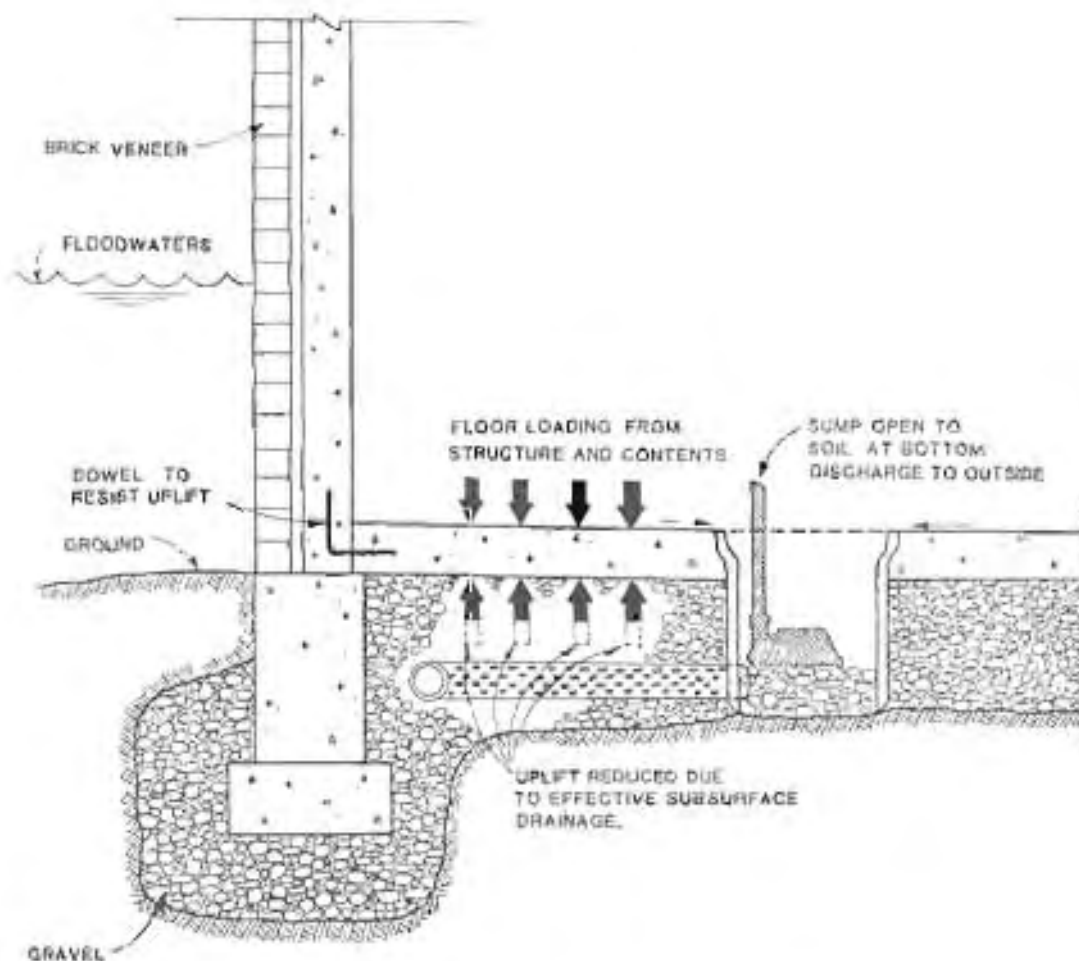

Figure III-19. Drained Subfloor Detail

e) Pressure Relief Systems. As an added degree of protection against structural failure of a new building, or for an existing structure that cannot be modified to reduce uplift pressures, it is generally desirable to install some type of pressure relief system.

If sump pumps are used, the bottom of the sump area may be left open to the foundation soils or relief pipes may be used to direct water from beneath the floor slab to an enclosed sump area. These provisions are required to provide an exit point to relieve pressures that might develop if the drainage system fails. Another method is to install pressure relief valves in the floor slab as shown in Figure III-20. These valves are designed to allow water to flow into the structure at some pressure that is below the

structure failure point. Experience has shown that a 4" diameter valve should be installed for every 750 square feet of floor slab space. More valves should be located near the exterior walls than toward the center of the slab.

d) Anchorage. Another technique that can be used to stabilize a structure against flood forces is the integrated anchorage of all structural elements. For example, concrete foundation walls, piers or posts may be anchored to footings with hooked 1/2" rods extending from the footing to the cap. Anchor bolts 4' to 6' apart may be used to anchor sills or plates to the foundation walls. (See details in Figures III-14 and III-15.)

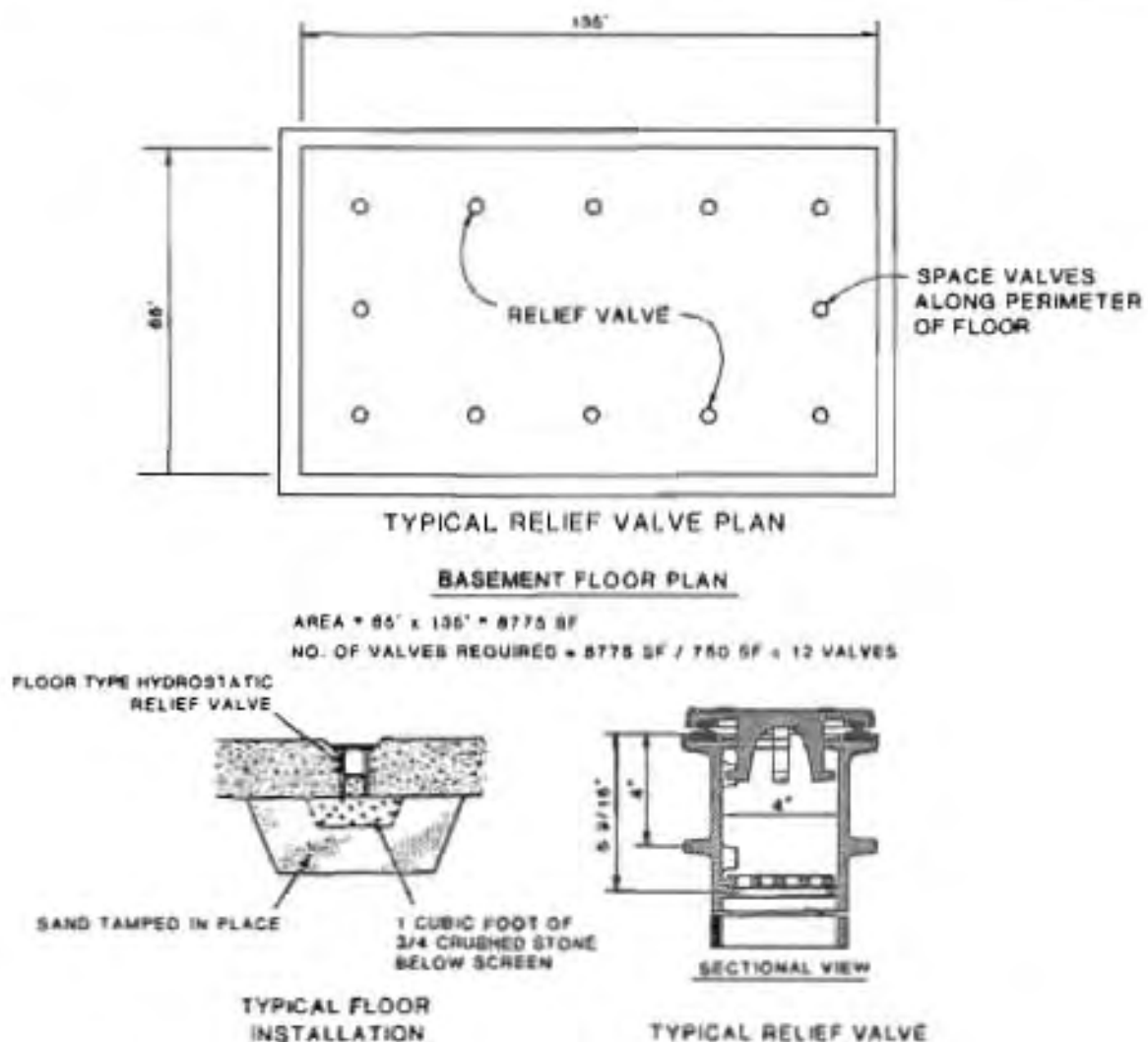

Figure III-20. Typical Pressure Relief Valve System

5. WATERPROOFING. Concrete and masonry walls are not generally impermeable unless special construction techniques are applied. Waterproofing can be accomplished through the use of (a) high-quality concrete, (b) sealant materials, and/or (c) impermeable membranes.

Sealing existing walls and floors can significantly increase hydrostatic pressures unless an alternative drainage system is provided. If an existing structure cannot be designed to withstand anticipated pressures, the most feasible course of action may be to allow water to continue to enter through existing structural faults and remove the water with a sump pump.

a) Integral High Quality Concrete Construction. An impervious concrete can generally be obtained by using a richer cement mix than normal with well-graded fine aggregate. The consistency of the concrete should be as stiff (low water content) as possible and the mixture should be thoroughly worked as it is placed. Leakage through joints can be prevented by the use of grouted structural keys and non-corrosive waterstops. Typical water-tight construction details are shown in Figure III-21.

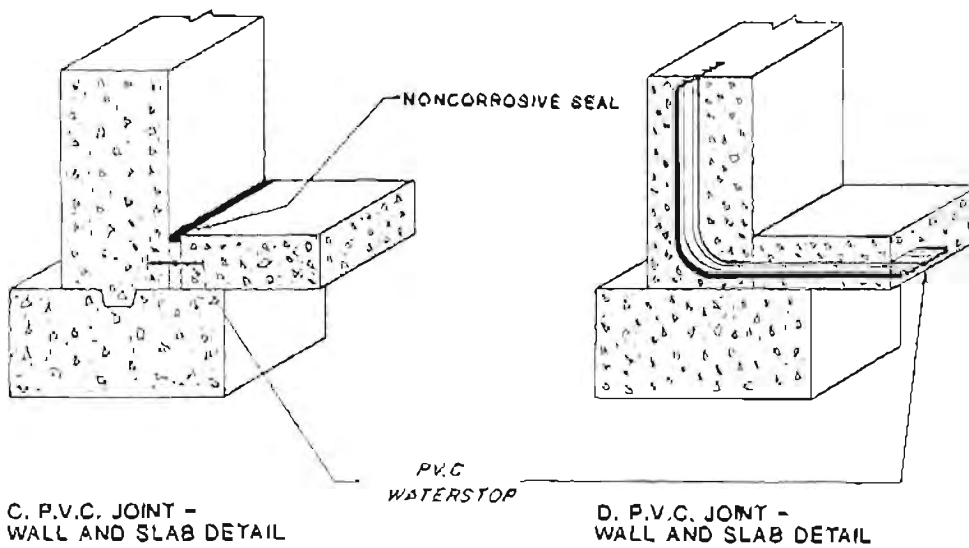
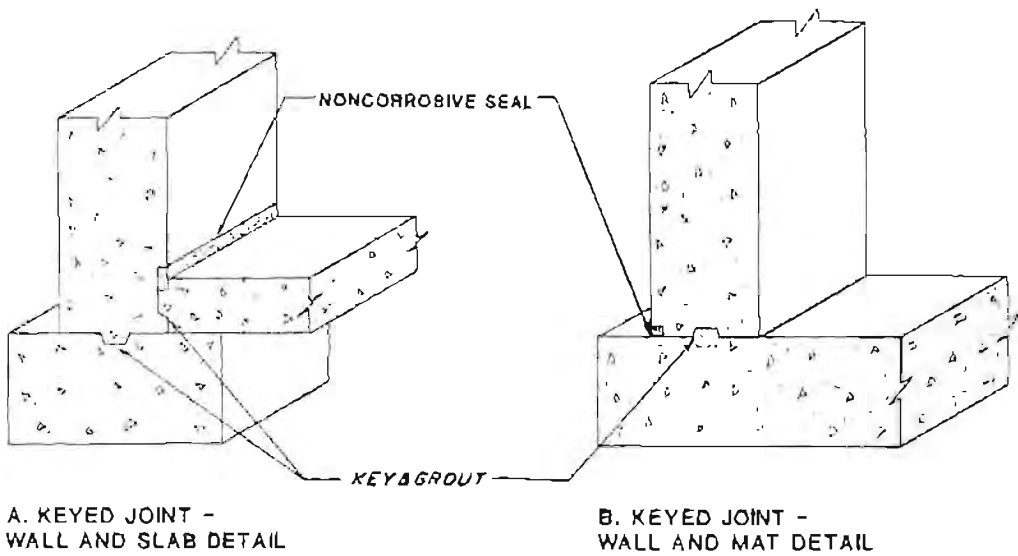

Figure III-21. Waterproof Wall and Foundation Joint Details Integral Concrete Waterproofing

Source: Anti Hydro Company

The water-tightness of very lean (low in cement) concrete mixtures will be improved by the addition of almost any fine, inert material. Their function is to fill the voids or pores of the concrete with a more or less soapy, insoluble filler, and thus prevent the percolation of water through the concrete. Substances that may be used included finely ground clay or sand, hydrated lime, chloride of lime, oil emulsions, and lime soaps. The increased plasticity resulting from the use of this material will reduce segregation and improve workability. Water-repellent admixtures reduce absorption and retard moisture penetration by capillary action, but are not effective against water under pressure.

Waterproofing admixtures are commercially available. A typical mix design consists of 1 part portland cement and approximately 5 1/2 parts of clean, well-graded fine and coarse aggregates designed

for maximum strength and denseness. Each cubic yard contains a minimum of 5.6 bags of portland cement and not more than 39 gallons of total liquid, which includes 1 1/2 gallons of the manufacturer's admixture. (Source: Anti-Hydro Company.)

b) Sealants. Masonry and concrete structures may be waterproofed by applying sealants to interior and/or exterior surfaces that are exposed to floodwaters (see Figure III-22). Common sealant materials include hydraulic or portland cements and a variety of bituminous materials that may be applied hot or cold. Exterior applications are generally preferred. Sealants may also be used between structural elements (i.e., between a structural floor slab and a concrete topping slab, or between a concrete masonry wall and a layer of brick veneer as shown in Figure III-23).

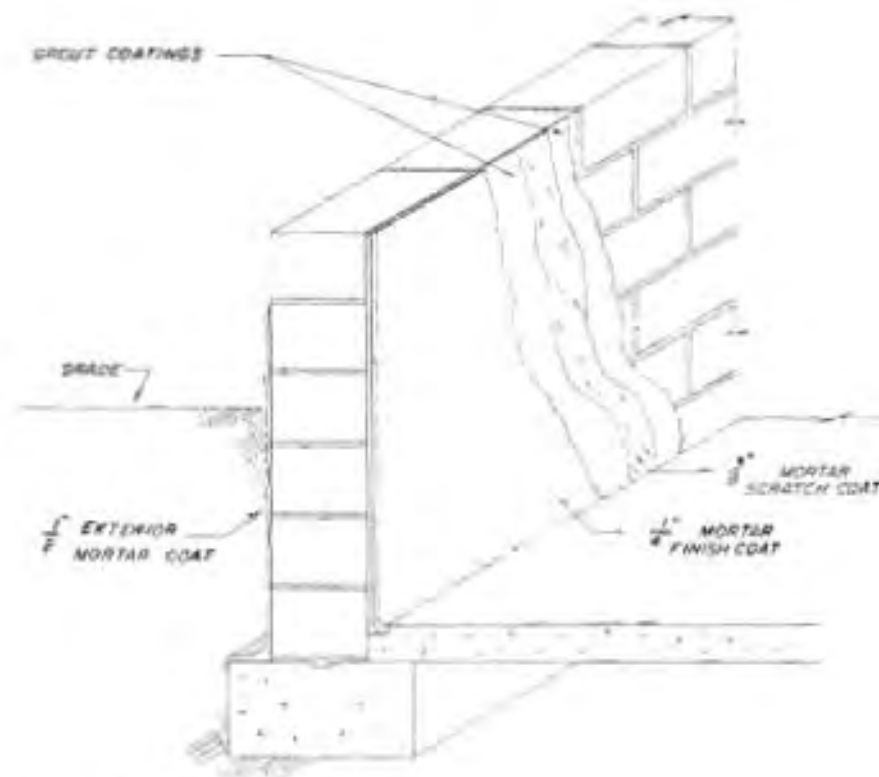

Figure III-22. Waterproofing With Mortar Sealant Coatings

Source: Anti Hydro Company

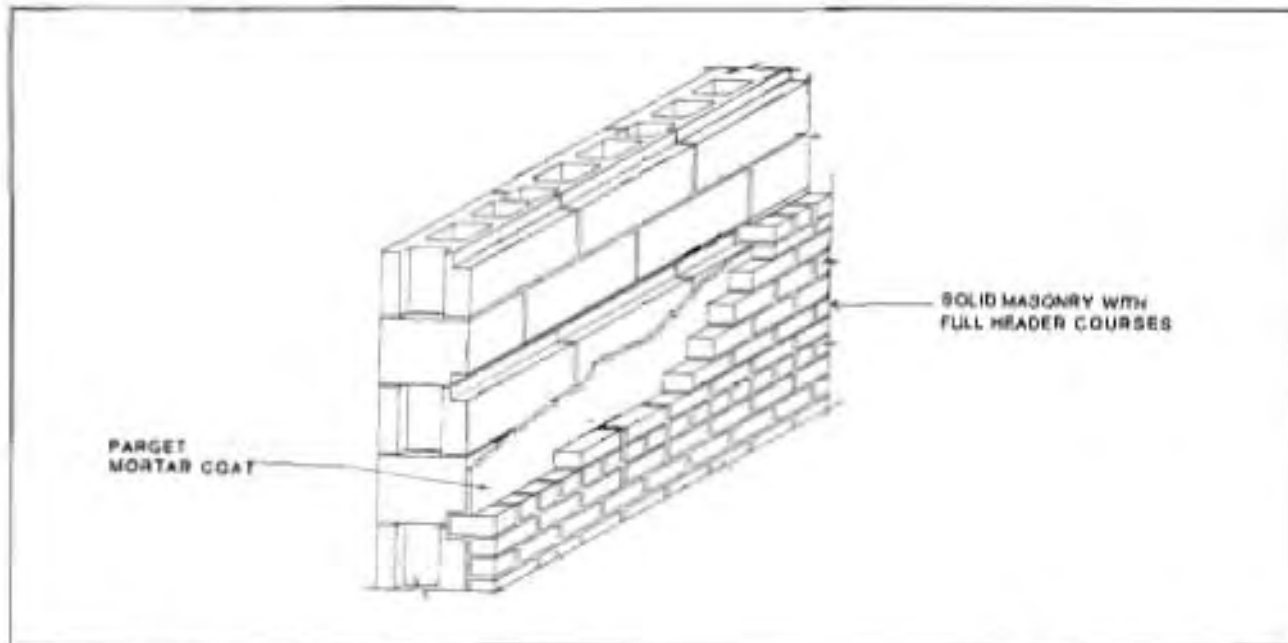

Figure III-23. Sealant Applied Between Masonry Block Wall and Exterior Veneer
Source: Anti Hydro Company

c) Membranes. The membrane method of waterproofing consists of surrounding all flood-prone surfaces of a structure with an impermeable membrane. Common membrane materials include PVC sheets, or coatings of felt, canvas or similar materials that are set in layers of hot bituminous coatings (coal tar, pitch, or asphalt). The membrane method of waterproofing is applicable to all types of masonry and concrete construction. To be effective, the membrane must be continuous and it should be protected against injury by a layer of brick, concrete or sand (Figure III-24). An existing building may be waterproofed on the inside by applying a membrane and then constructing an additional wall and slab within the existing wall and slab.

6. WATERTIGHT CORES. When waterproofing of exterior walls is not feasible for either physical or economic reasons, it may be possible to create a watertight core around an interior area. Watertight cores are particularly effective when costly items are located together in a small part of the building. For example, vital utilities or expensive equipment might

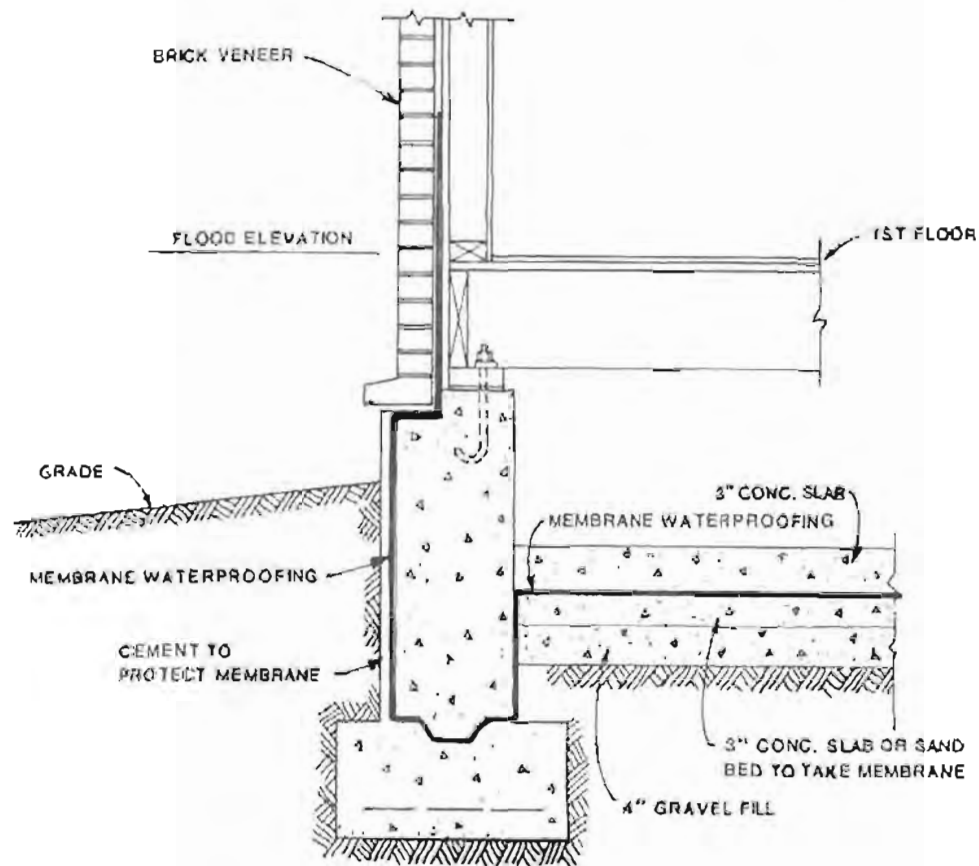

Figure III-24. Membrane Waterproofing

be enclosed by such a core. The top of the core wall must be as high as the Design Flood elevation plus suitable freeboard. A typical watertight closure is constructed of reinforced cast-in-place concrete. The design of core walls and the floor system follows the guidelines discussed in previous sections. The core system must be capable of withstanding uplift and lateral flood forces, and all water-proofing considerations discussed earlier must be met.

With the exception of very low walls (less than 18 inches), access openings, steps or ramps must be provided. The use of openings requires that flood shields be available (to be presented in the next section). An advantage of this type of access is that normal entry and exit to the area occurs during non-flood conditions. Disadvantages are the difficulty in assuring a watertight seal for the shield, storage of the shield, and insuring that the shield is properly installed in a timely manner.

Providing steps as access to the area eliminates the problems associated with flood shields, but entails more difficult entry and exit. This may be a problem for areas of heavy traffic. In addition, steps may not be feasible if bulky or large amounts of material must be moved in and out of the area. Access for handicapped personnel is also limited. Ramp access eliminates many of the problems of both openings and steps.

Ramps may even be made to accommodate machinery, if necessary. The primary disadvantages to a ramp system is the additional space required for the ramp.

The type of access provided for a watertight core is a function of the particular needs and usage of the area as discussed above and must be selected by the designer.

7. CLOSURES AND FLOOD SHIELDS. If the walls and floor of a structure can be designed or modified to provide the required impermeability and resistance to flood forces, then permanent or temporary closure systems may be used. Closures and shields must be able to support all flood loads that act on their surfaces. In addition, the closure or shield must be installed so that flood loads are uniformly transferred into the supporting walls or structural elements of the building.

For existing buildings, permanent closures are preferable if they do not alter the function or safety of the structure. Unused openings may be permanently sealed with concrete, masonry blocks or metal assemblies. All closure assemblies should be reinforced and keyed or anchored to the framing system, floor, or walls.

Flood shield assemblies must be used to protect openings that cannot be permanently closed. Shields may be constructed of any durable material that can withstand the design loads. The most common materials are steel and aluminum. Exterior grade plywood may also be used for openings that are not exposed to extreme loading conditions. For example, A-C grade exterior 3/4" marine plywood may be used with a maximum recommended unsupported span of 24". Plywood should be coated with fiberglass. Neoprene rubber gasket material may be used as a seal. Aluminum or steel reinforcement may also be used. Experience has indicated that it may be simpler and as cost effective to fabricate steel closures than to try to adapt plywood to this use.

The shields should normally be attached to the wet side of the opening so that the pressure of the water helps to seal the flood shield to the receiving frame. The frame, usually metal, should support the shield on at least three edges. Shields may be attached to their frames with standard bolts, T-bolts, latching dogs, wedge assemblies, or a variety of other latching devices. Preference should be given to simple, quick disconnect fasteners that can be activated with a minimum of time, effort, and skill. Regardless of the type of latching mechanism, the shield must be designed to ensure a watertight seal.

Several types of flood shields are illustrated in Figure 1-10. Figure III-25 through III-31 summarized below, provide details of various framing, sealing and latching techniques.

FIGURE	TECHNIQUE DESCRIBED
III-25	Recommended reinforcement of masonry walls around small openings
III-26	Flood shield for small basement window
III-27	Bond beams & vertical reinforcement of flood shields at large openings
III-28	Flood shield for typical door openings
III-29	Typical flood shield for display windows
III-30	Typical flood shields for horizontal openings below Design Flood level
III-31	Typical flood shield fastening methods

These details have been adapted from *Floodproofing Regulations* as published by the U.S. Army Corps of Engineers.

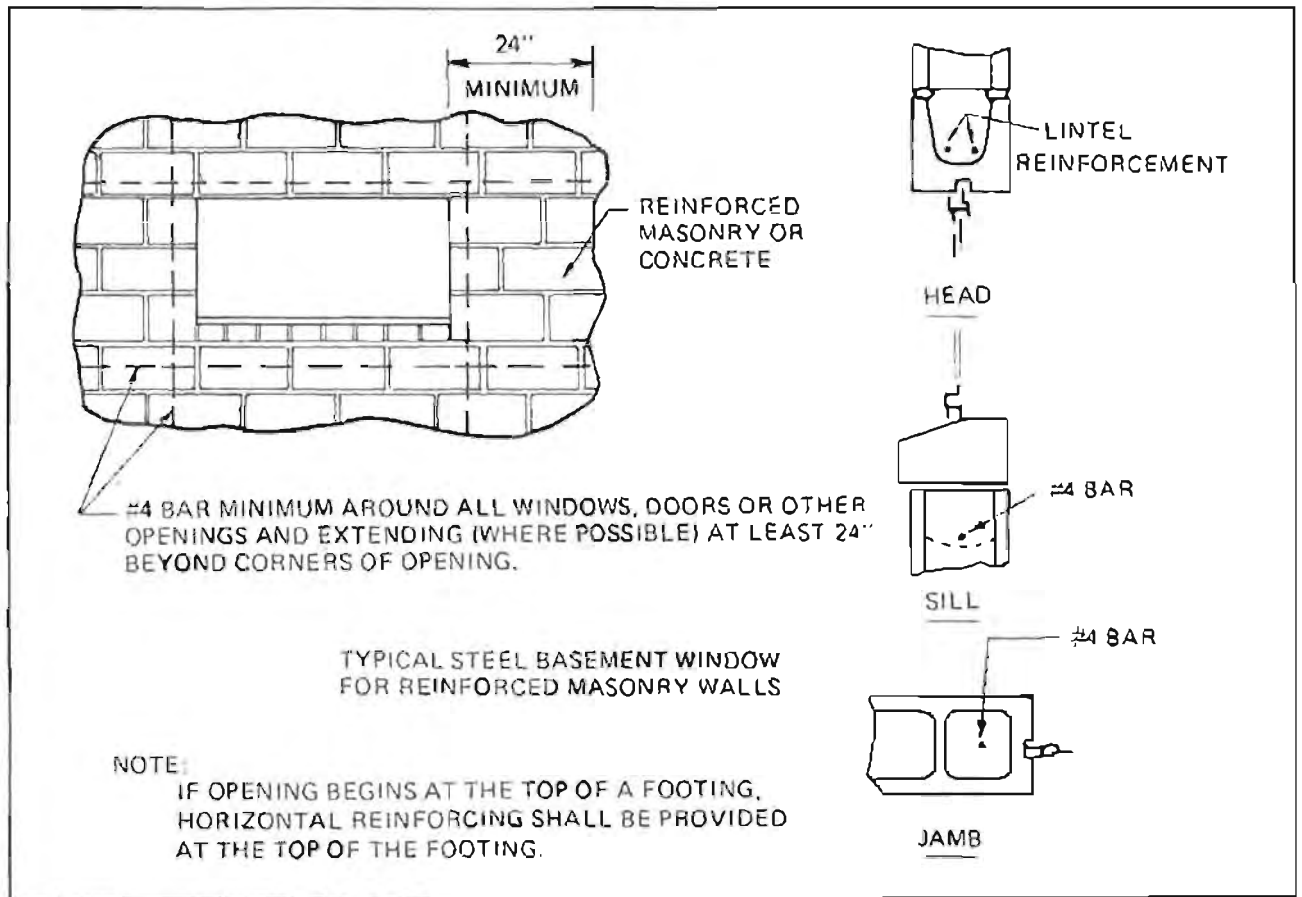

Figure III-25. Recommended Reinforcement of Masonry Walls Around Small Openings

Source: *Floodproofing Regulations*

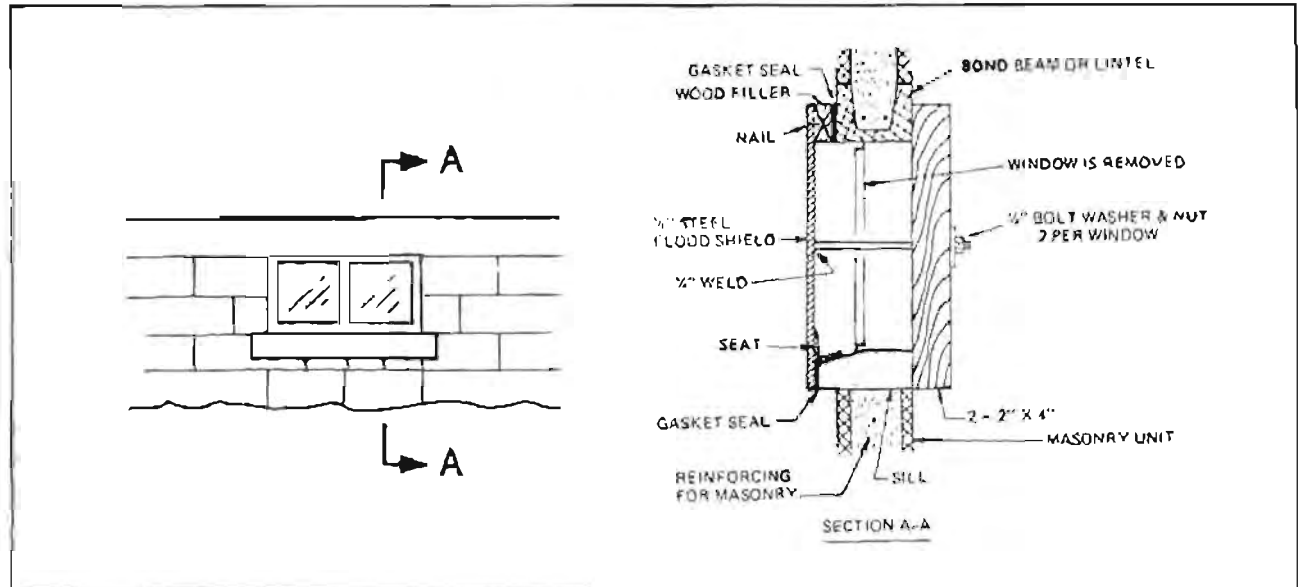

Figure III-26. Flood Shield for Small Basement Window

Source: *Floodproofing Regulations*

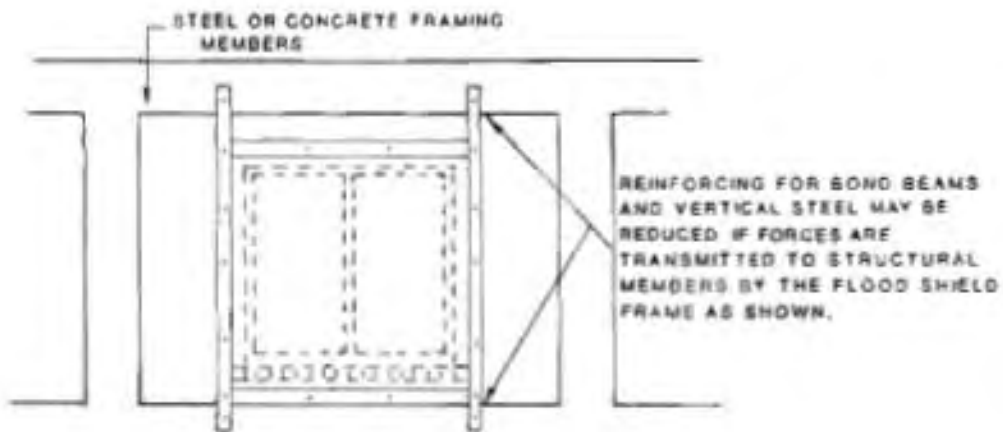
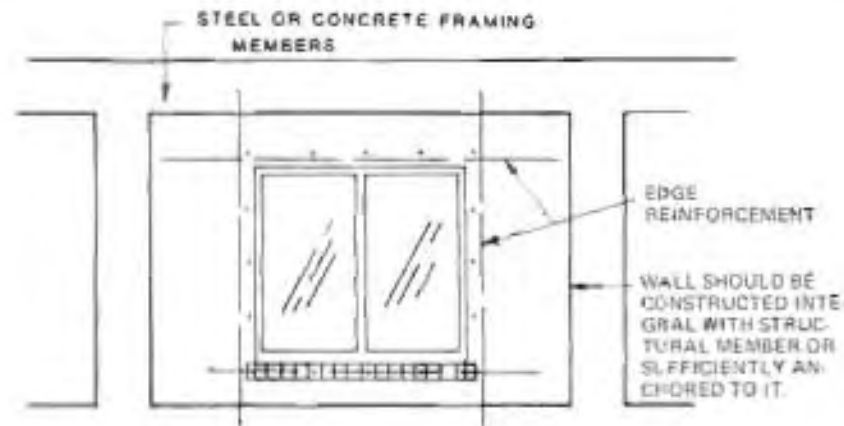
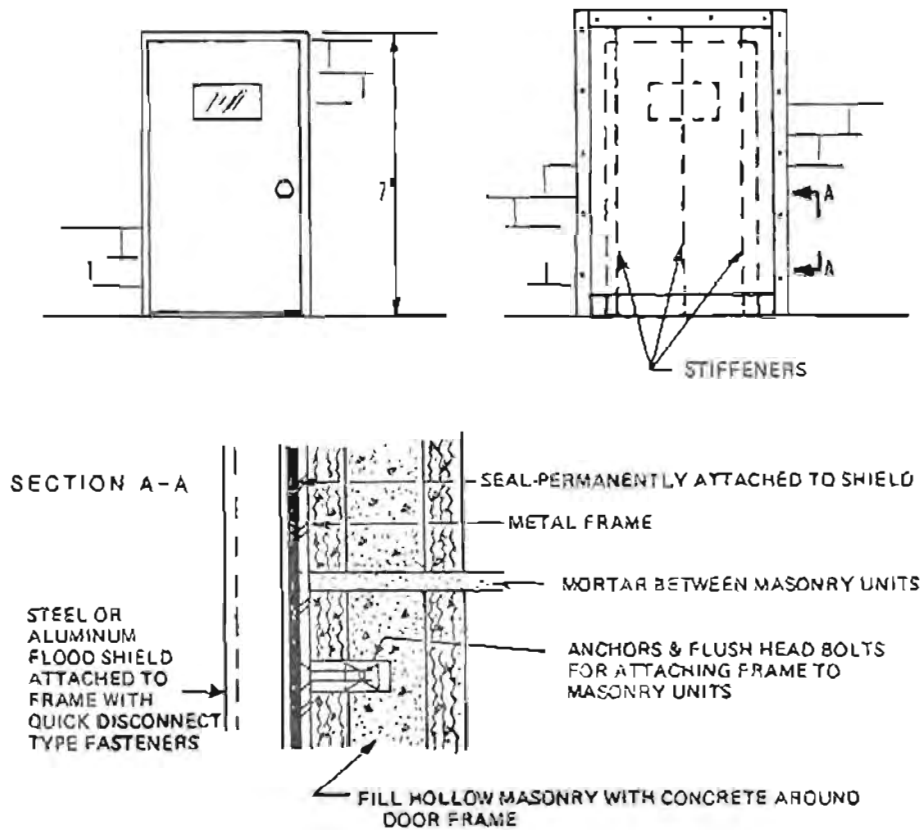

Figure III-27. Bond Beams & Vertical Reinforcement of Flood Shields at Large Openings

Source: *Floodproofing Regulations*

TYPICAL DOOR



ALL CELLS AROUND OPENINGS IN HOLLOW MASONRY CONSTRUCTION SHOULD BE FILLED WITH CONCRETE. LARGE OPENINGS SHOULD HAVE BOND BEAMS, VERTICAL REINFORCEMENT, AND METAL FRAMES AROUND OPENING.

MORTAR JOINTS THAT LIE WITHIN FLOOD SHIELD SHOULD BE STRUCK FLUSH WITH THE MASONRY UNITS SO THERE WILL BE A BETTER SEAL.

Figure III-28. Flood Shield for Typical Door Opening

Source: *Floodproofing Regulations*

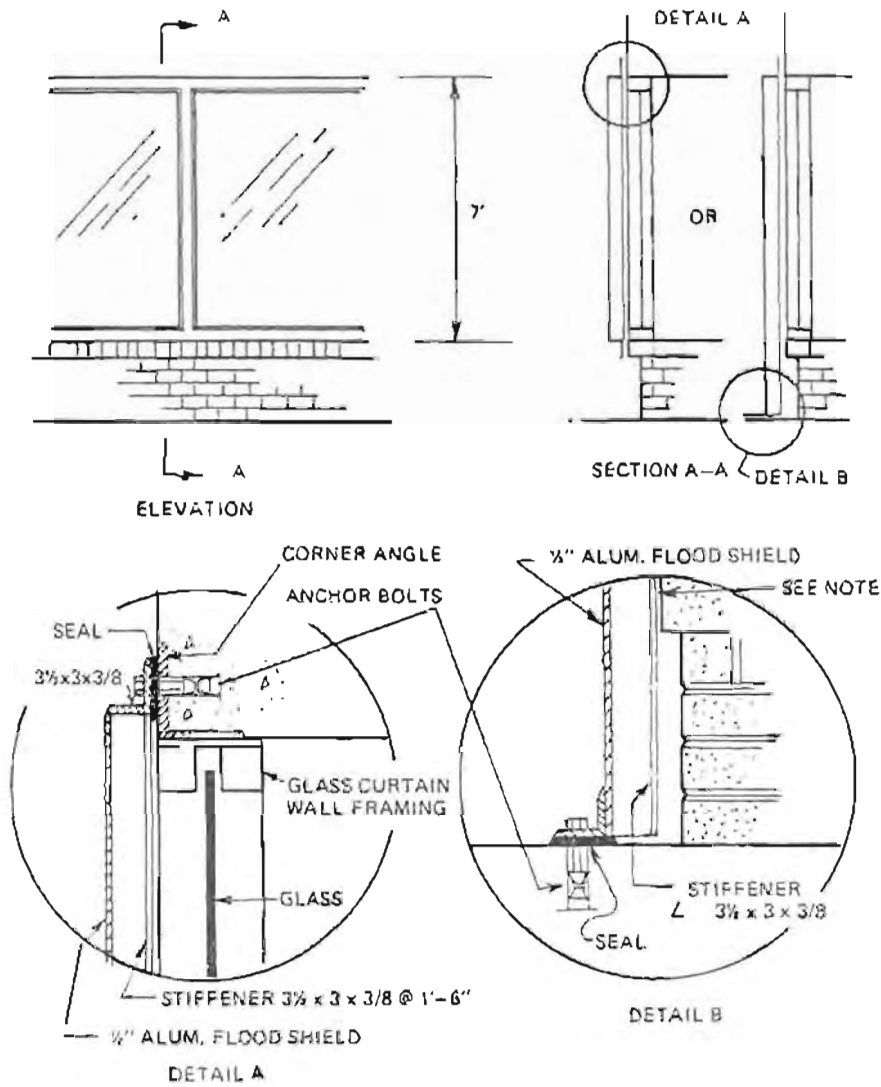

Note: The shield material specifications assume that support is available at the bottom of the display window (i.e. 7' high shield). If support is not available at this point, increase size or number of stiffeners and provide support at bottom. Members are sized for water level at top of display window.

Figure III-29. Typical Flood Shield for Display Windows

Source: Flood Proofing Regulations

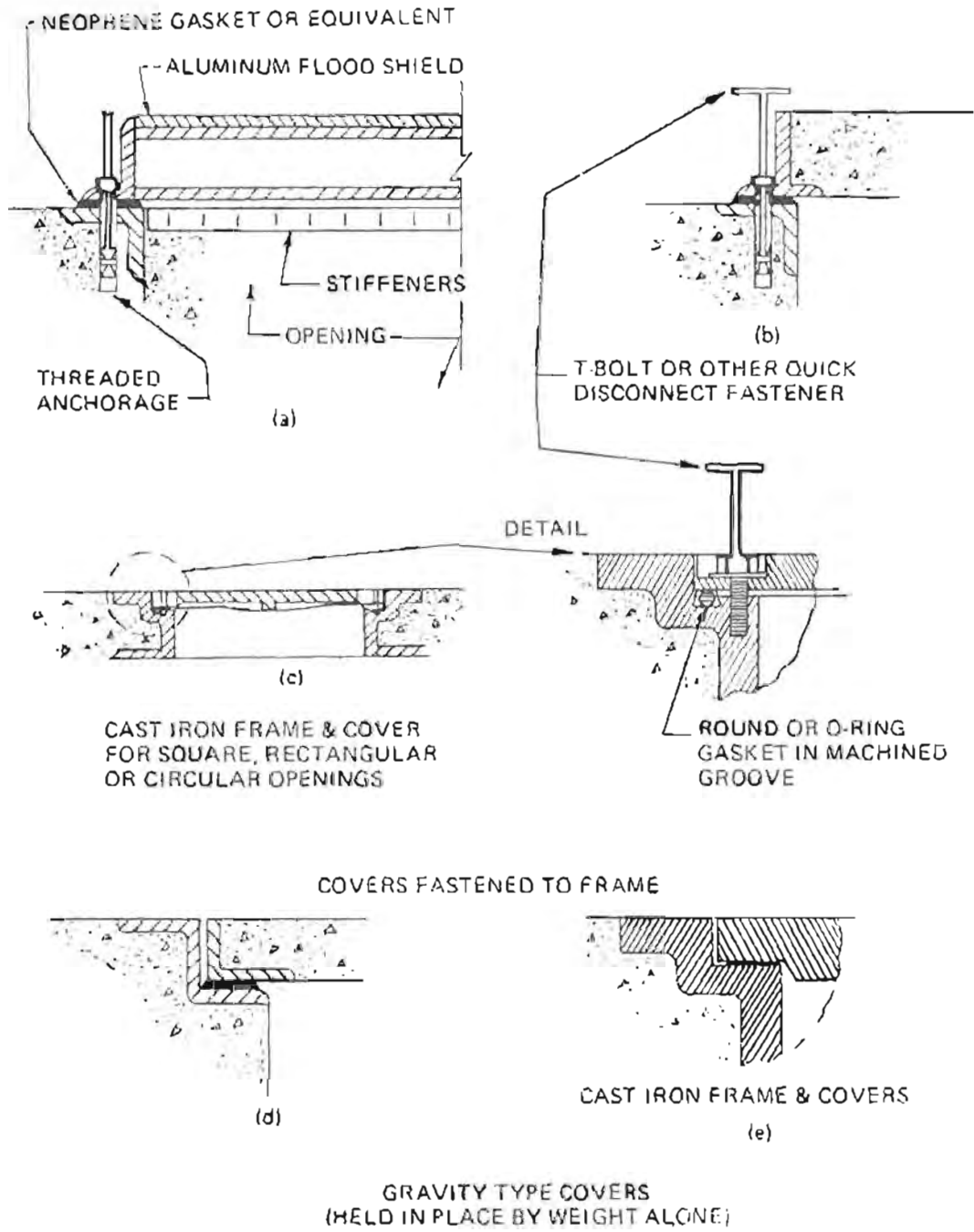

Figure III-30. Typical Flood Shields for Horizontal Openings Below Design Flood Level
Source: Flood Proofing Regulations

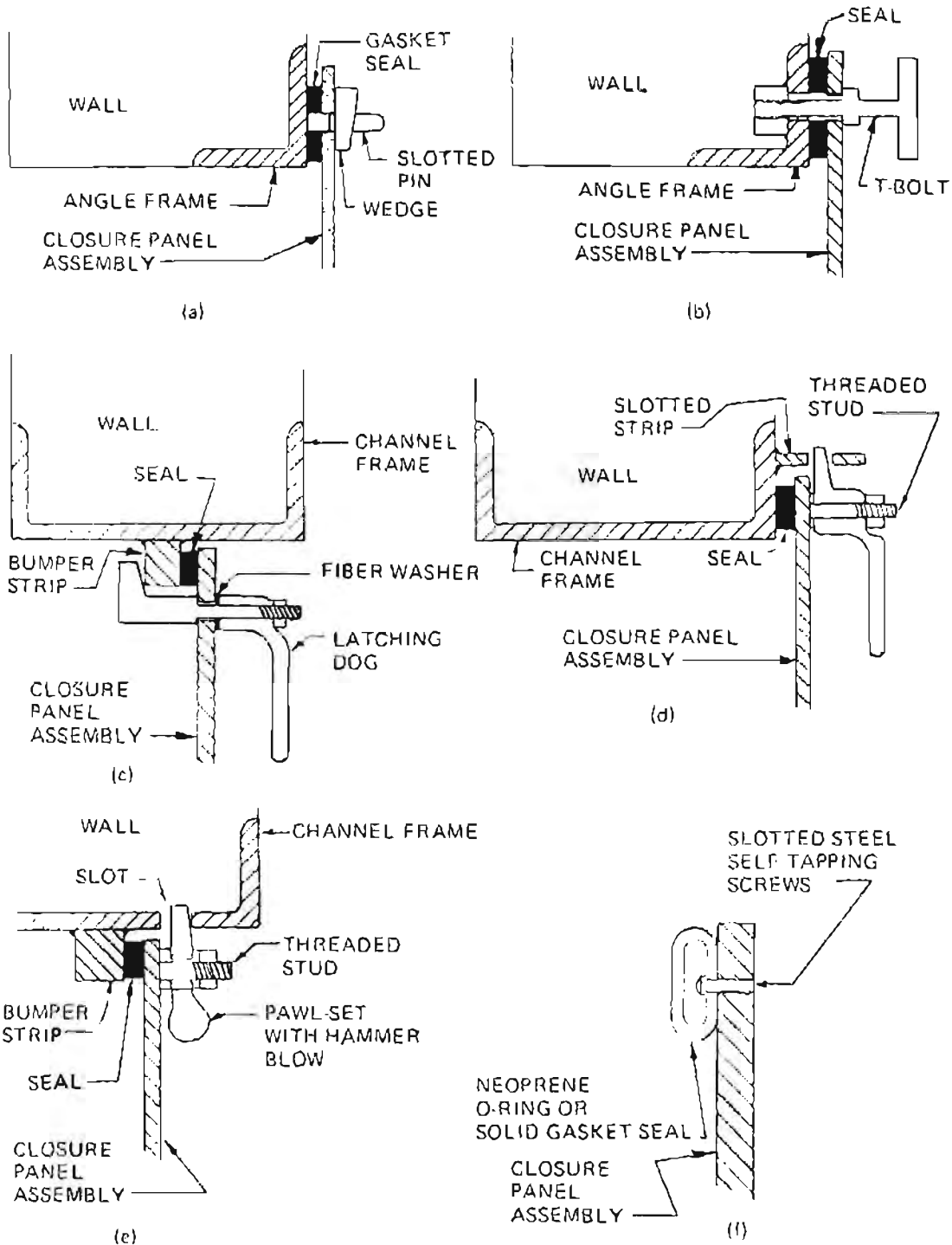

Figure III-31. Typical Flood Shield Fastening Methods

Source: Flood Proofing Regulations

A variety of flood barriers and watertight doors are available commercially. Doors are closed by sliding, hand dogs or wheels and can be pneumatically sealed. Doors and barriers are constructed of structural steel or aluminum plate. Figures III-32 through III-37 illustrate some of the available doors and barriers.

FIGURE	TECHNIQUE DESCRIBED
III-32	Watertight hinged double doors
III-33	Watertight quick acting hinged doors
III-34	Watertight sliding door
III-35	Bottom hinged flood barrier
III-36	Manually installed flood barrier
III-37	Fork lift installed flood barrier

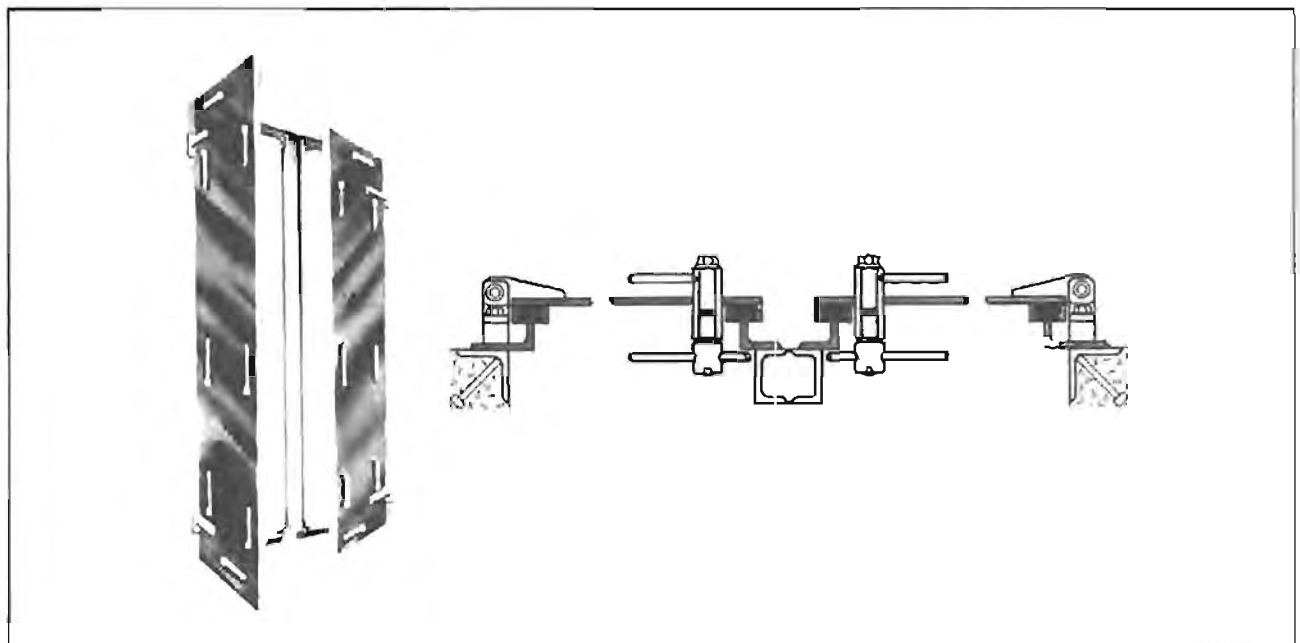

Figure III-32. Watertight Hinged Double Doors

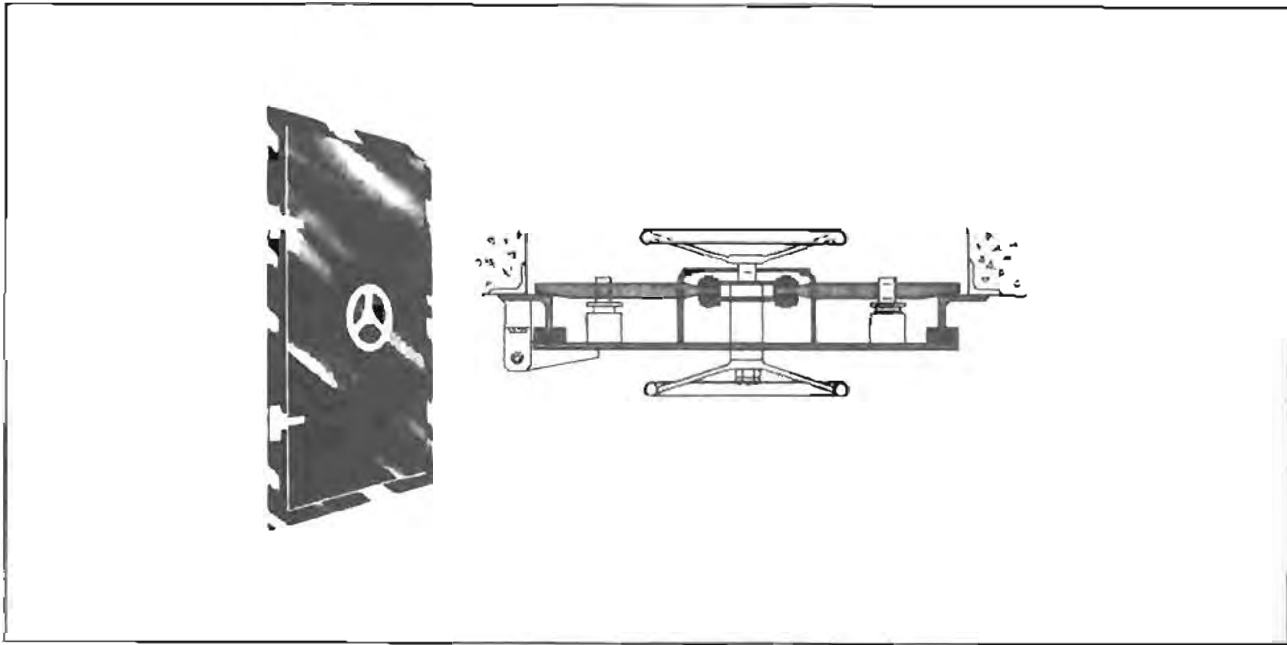

Figure III-33. Watertight Quick Action Hinged Doors

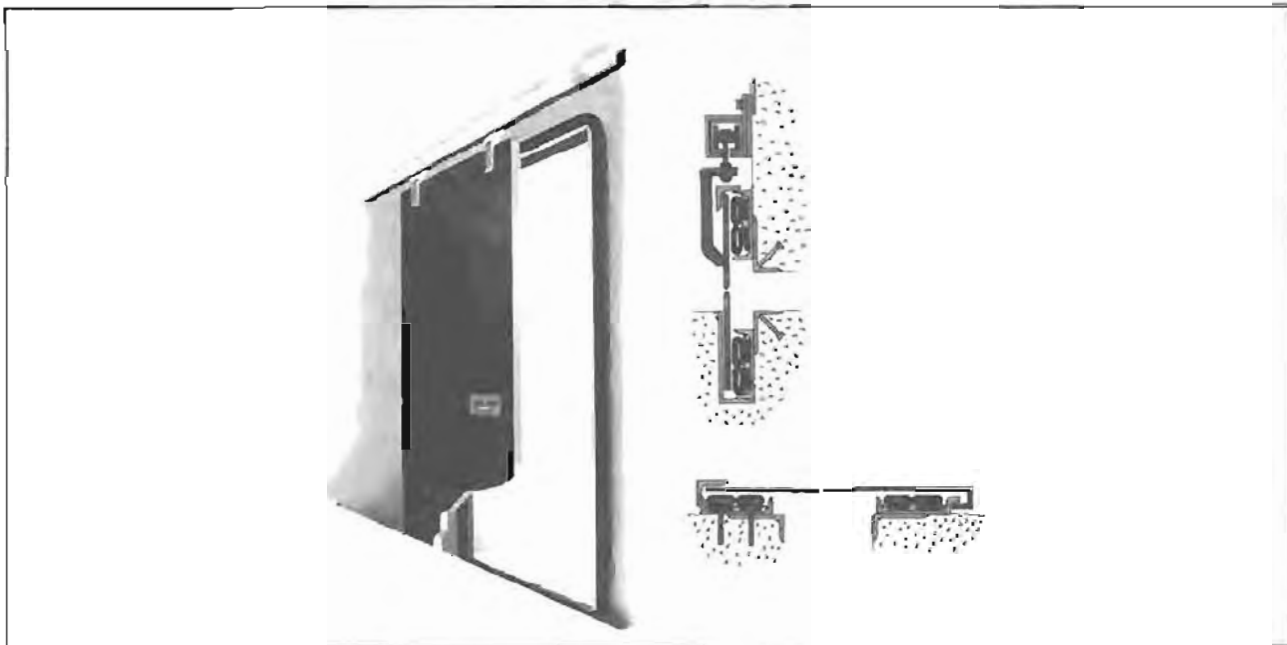

Figure III-34. Watertight Sliding Door

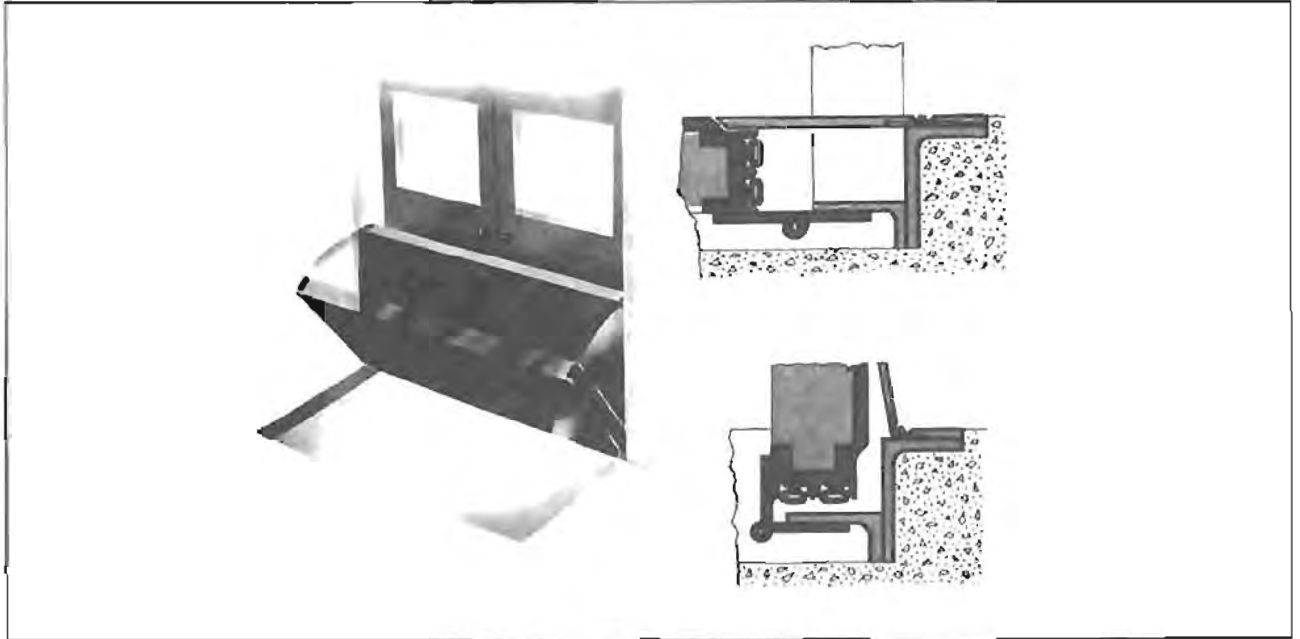

Figure III-35. Bottom Hinged Flood Barrier

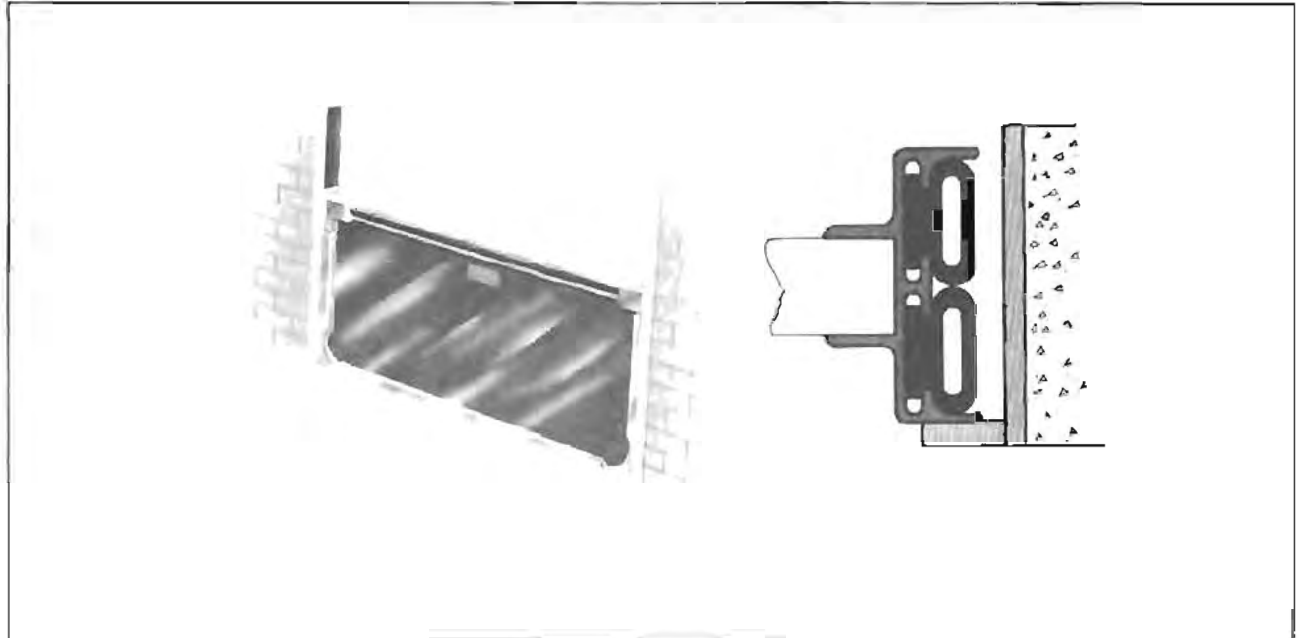

Figure III-36. Manually Installed Flood Barrier

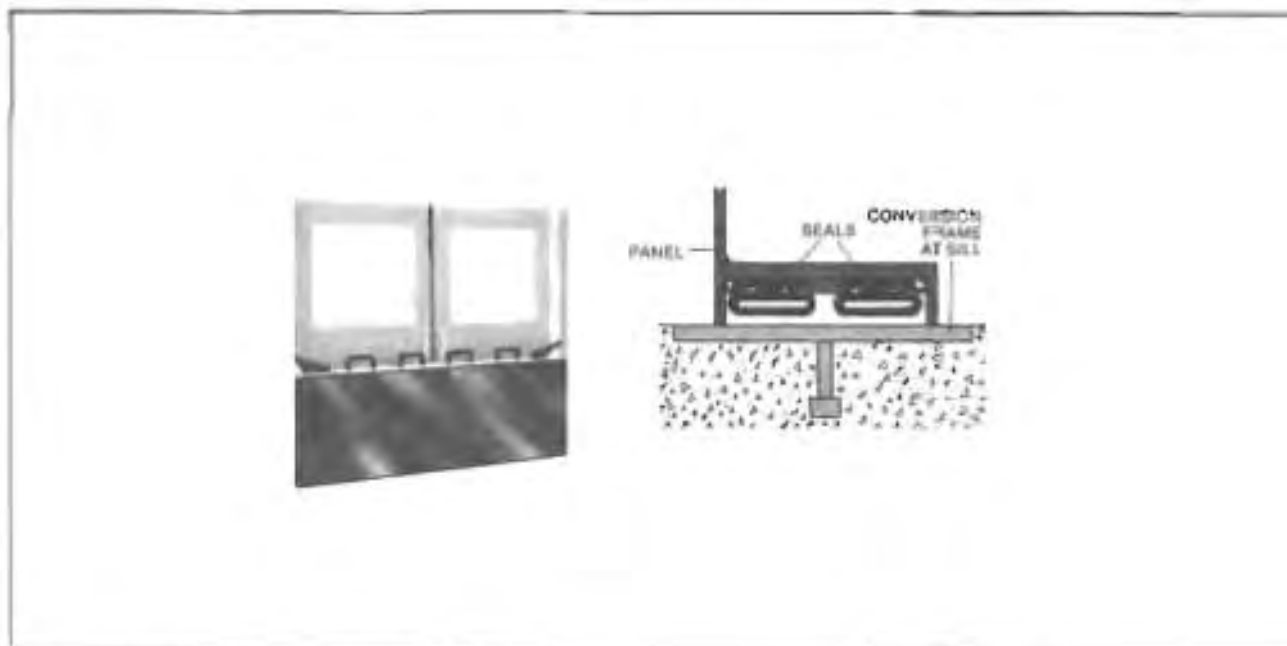

Figure III-37. Fork Lift Installed Flood Barrier

8. TESTING, STORAGE AND

MAINTENANCE. It is recommended that new flood shields should be installed and tested before they are used. Testing may be performed by constructing a concrete block wall or plywood bin around the outside of the installed shield and filling it with water to at least the Design Flood elevation. A plywood bin may be constructed of 3/4" exterior plywood attached to 2" x 4" studs and 2" x 4" braces at 16 or 24 inch spacing. For very large openings, mortar reinforced concrete blocks may be used to construct the bin. The bins should be lined with polyethylene to minimize water loss. The test depth should be monitored as frequently as necessary to ensure full hydrostatic loadline throughout the test period. The length of the test period should always be greater than that which would be expected in actual flooding, but never less than 24 hours. During the test the interior of the shield should be monitored frequently to determine the location and extent of any leakage that may occur. (See Figure III-38).

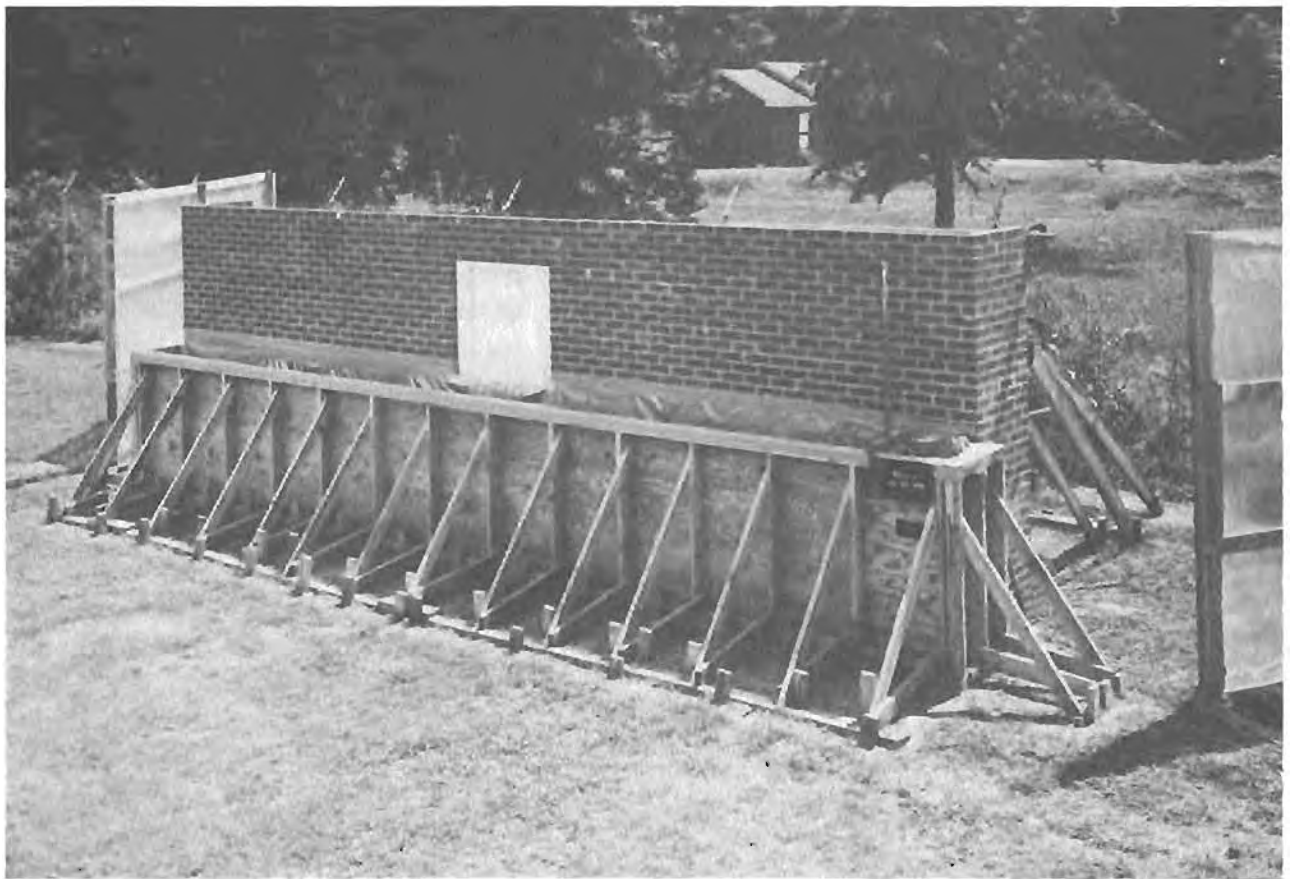

Figure III-38. Testing Bin

Provisions must be made for storing flood shields when they are not in use. Storage areas must be carefully planned and maintained to ensure that the shields can be located and installed with a minimum of effort and time. The storage area should be as close to the openings to be sealed as possible. In addition, any tools, hardware, or equipment that is needed to attach the shields should be conveniently located at the storage area or installation site.

For complex flood protection systems, a master checklist for the installation of shields, pump operation, and valve closures should be prepared. Pump and valve locations and all shields should be numbered and color-coded based on installation and operation priority. For example, low levels of flooding might have a white color code, with intermediate levels up to the design flood. Figure III-39 illustrates the format of such a checklist.

For the most part, permanent closures, doors, and barriers require little or no special maintenance. If the closures use gaskets or sealants, these items will have to be inspected annually and perhaps changed every ten years.

Flood shields require more attention. Flood shields should be inspected and function tested at least once a year to assure serviceability. All of these temporary systems require gaskets and sealants which must be checked and replaced as necessary.

All systems, such as sump pumps, special utility protections, and backflow preventor or check valves in sewers require annual testing.

CHECKLIST					
Priority - WHITE					
<i>Item</i>					<i>Notes:</i> 1. Normally closed. 2. Tools required. 3. Valve closes a main drain. Pumps should be prepared to start pumping when water appears in sumps at this location. 4. Valve closes down main drains. If system is not surcharging, it may be left open, but pumps should be ready for continuous operation. 5. Valve closes overflow from sump. Can be shut at any time after water recycling system is shut down. 6. For hatch, apply a layer of polyethylene and hold down with sandbags. Overlap the frame by 2 feet and apply the sandbags three deep along the edge.
<i>Number</i>	<i>Bldg.</i>	<i>Item</i>	<i>Notes</i>	<i>Remarks</i>	
1	#3	Shield	2		
2		Shield	1,2		
3		Door			
4	#1	Double Door			
Priority - YELLOW					
5	#2	Shield	2		
6		Double Door	1		
7	#3	Valve	2, 3	Main Drain Valve	
Priority - ORANGE					
8	#1	Valve	2, 4	Main Drain Valve	
9		Shield	2		
10	#2	Valve	2, 5	Main Drain Valve	
Priority - RED					
11	#2	Rolling Door			
12		Hatch	6		

Figure III-39. Sample Flood Protection Installation Master Checklist

E. FLOODWALLS AND LEVEES

1. GENERAL. As described in Chapter II, floodwalls and levees may be used to prevent floodwaters from reaching an individual structure and adjacent functional land areas. Floodwalls and levees may be used to protect a structure on all sides, or to protect the low side of a structure that is located on the edge of the floodplain.

Experience has shown that floodwalls and levees can be used to effectively protect individual structures from flooding depths up to 7 feet. The feasibility of floodwall protection for depths that exceed 7 feet are often limited by the cost of design and construction; while the height of a levee is generally limited by the amount of construction space that is required to accommodate embankment side-slopes.

The design requirements for a particular floodwall or levee are generally variable and complex. However, the information presented in this section can be used to evaluate the initial feasibility of a floodwall or levee at a particular site and to develop conceptual design plans. This section begins with a presentation of site survey (Part 2) and internal drainage (Part 3) requirements that are applicable to floodwall and levee projects. Part 4 and 5 present guidelines that are unique to the design of floodwalls and levees, respectively.

2. SITE SURVEY. Floodwall and levee design analysis should begin with a careful review of the site-specific factors that govern the feasibility of these measures. As an initial step, hydrologic data should be gathered and reviewed (as discussed in Chapter II) to determine the Design Flood elevation, anticipated flood water velocities, the duration of flooding and the potential impact of floodwall or levee construction on existing channel capacity. All regulatory restrictions associated with floodwall or levee construction shall be investigated to determine the feasibility of obtaining any required construction permits (see Chapter II).

Once this information is known, topographic maps can be used to identify the most logical location and alignment of the floodwall or levee. The structure

grade or design elevation must be established to protect against the Design Flood plus allowances for residual settlement and/or freeboard. (Freeboard is the vertical distance between the top of the floodwall or levee grade and the Design Flood elevation.) The freeboard allowance provides a margin of safety against wave and scour action, overtopping, and the inherent uncertainties of estimating techniques used in establishing the Design Flood elevation. Freeboard allowances for floodwalls and levees have not been strictly standardized, but as a general rule, a minimum value of 3 feet is often used. However, freeboard of less than 3 feet, even as low as 1 foot, may be acceptable, depending upon applicable construction regulations, provided that protection against the Design Flood can still be achieved. The latter conditions would more likely be attained for the construction of floodwalls, due to their comparatively greater structural integrity.

Topographic maps may also be used to evaluate potential problems of surface drainage accumulation on the 'dry' side of the floodwall or levee, and in the identification of appropriate access points through, across, or above the proposed structure.

After the floodwall or levee alignment has been established, the designer must assemble geotechnical information to determine the properties of foundation soils that will support the floodwall or levee. For levee design, it will also be necessary to identify the physical properties of available construction material. Initial geotechnical studies must determine soil bearing capacity, permeability, and depth to an impervious stratum. For small floodwalls and levees (less than 10 feet high, 1000 feet long) a limited number (depending on the homogeneity of underlying conditions) of soil test borings supplemented by a thorough field reconnaissance will generally provide adequate design information. Foundation materials have been classified as:

a) Ledge Rocks. Ledge rocks present a potential permeability hazard and frequently need grouting.

b) Fine Uniform Sands. If below 'critical density' (void ratio at which a soil can undergo deformation without change of volume) fine uniform

sands must be consolidated to prevent flow when saturated under load.

c) **Coarse Sands and Gravel.** From a stability standpoint they will consolidate under load. A streamside impervious blanket may be required to prevent seepage.

d) **Plastic Clays.** They require careful analysis to assure that shear stress imposed by the weight of the levee or floodwall is less than the shear strength of the foundation material; flattened levee side slopes may be required to reduce shear stress.

If the preliminary investigations identify specific problems, more detailed geotechnical studies may be required.

3. INTERIOR DRAINAGE SYSTEM.

Floodwall and levee systems must be designed to reduce or eliminate the accumulation of seepage and/or internal surface runoff on the dry side of the structure. If adequate space is not available to temporarily store all seepage and runoff that is likely to occur at the site, excess water must be drained to low lying sump areas and pumped to the wet side of the floodwall or levee. The pump discharge level should be located above the Design Flood level.

The drainage system for the interior area enclosed by a levee or floodwall must accommodate the precipitation runoff from the interior area and the anticipated seepage through the levee or floodwall during flooding conditions. A means of positive drainage for the interior of the floodwall or levee area is needed to discharge the accumulated water outside the enclosed area.

First, a collection system composed of pervious trenches or underground tiles must be designed to transport the accumulating water to a sump area. In the levee application, these drains should be incorporated into the collection system. The anticipated seepage from under and through levees and floodwalls must also be taken into consideration. To determine the amount of precipitation that can collect in the enclosure, the rainfall intensity must be determined for a particular location.

Using Figure III-40, a value is obtained in inches per hour. This value should be multiplied by both the area in square feet and a conversion factor of 0.01. The product will be in gallons per minute. In some cases, a levee or floodwall extends only partially around a property and ties into higher ground. For these cases, the amount of precipitation that can flow downhill as runoff into the enclosure must be included. To calculate this value, the area of land in acres that can discharge water into the enclosure should be estimated. This value is then multiplied by the previously determined rainfall intensity and by the most suitable terrain coefficient provided in Table III-2. The product of these three values is the rate of flow in gallons per minute into the enclosure.

TABLE III-2
TERRAIN COEFFICIENTS

Roof	.85
Street, parking lot	.85
Urban area, paved areas	.80
Industrial area	.70
Residential area (homes or apartments)	.60
Unimproved vegetated areas	.20
Grass Area grade is 7 percent or more	.25
Grade is 2 percent to 7 percent	.15
Grade is flat to 2 percent	.10

Seepage flow rates from the levee must also be estimated. In general, unless this seepage rate is calculated by a qualified soils engineer, a value of one gallon per minute for every 100 square feet of levee or floodwall enclosed area should be assumed. The values for precipitation within the enclosed area, runoff areas uphill draining into the enclosure, and seepage through the levee or floodwall should be added together, and the sum multiplied by a safety factor of 1.5.



Figure III-40. Rainfall Intensity for 50-year, 60-Minute Duration For United States.

The result is the minimum discharge size in gallons per minute (gpm) of the sump pump. The pump to discharge the collected water from the interior of the area should be a submersible-type model mounted in the sump basin with a backup electrical generator. The backup electrical generator should be available during power outage, which is often the case during flooding conditions.

Under normal circumstances, the electrical service from the structure can operate the pump. The pump controls should consist of three float-type mercury tube switches to activate the pump, turn it off, and to signal high water levels. The pump motor should be fully submerged in an oil-filled chamber providing efficient heat dissipation, permanent lubrication, and sealing for complete protection from the environment. The pump should have a semi-open, non-clog type impeller capable of passing a 2-inch solid sphere without damage. The housing should be cast iron with corrosion resistant fasteners and a mechanical seal between the pump and motor. A check and gate valve should be installed on the discharge piping.

An alternative might be a suction-type pump powered by a gasoline engine. A control system should consist of water level switches automatically operating an electric starter for the gasoline engine. The pump performance should match that of the submersible pump described above. The major disadvantages of this system are the need for constant monitoring of fuel levels, and the additional cost of control and starter implementation.

During non-flood situations, surface runoff within the protected area may be discharged through drainage pipes or culverts that extend through the floodwall or levee. These outlets must be equipped with an automatic check valve to prevent backflow during a flood. Backflow prevention valves will also be required on all sewer and other underground utility lines that extend into the floodproofed building (see Chapter IV, part C).

4. SEEPAGE. If a floodwall or levee is constructed on impervious soils that extend riverward for a considerable distance, seepage beneath the structure may not represent a problem. However, underseepage through pervious foundation materials can cause hydrostatic pressures at the dry side base of a floodwall or 'toe' of a levee. This pressure may result in piping beneath the structure and heaving and rupturing of adjacent soils.

There are a variety of techniques that can be used alone or in combination with each other to control underseepage. These techniques include landside berms, impervious cut-offs, pervious trenches and pressure relief wells as described below.

a) Landside Berm. Landside uplift pressure can become greater than the effective weight of a levee structure. The construction of a landside berm (where space is available) can eliminate this hazard by providing additional weight to counteract uplift pressures at the toe of the levee. A landside berm may be used to reinforce an existing impervious or semipervious top stratum; or, if none exists, the berm may be placed directly on pervious deposits.

b) Impervious Cut-off. Where foundation and/or levee construction material is relatively permeable, an impervious cut-off should be installed to reduce seepage. Impervious cut-offs for levees include sheet piling or cement curtain cut-offs (Figure III-41), compacted impervious fill that extends to an impervious stratum (see Figure III-42), or an impervious blanket (Figure III-43). Sheet piling and cement curtains may also be used to prevent seepage beneath the key of a floodwall (Figure III-44). For cases where pervious foundation materials are deep, initial consideration should be given to steel sheet piling because of the relative ease of installing this type of cut-off.

c) Pervious Trench. If properly installed, the impervious cut-off system described above will eliminate major piping of water under a floodwall or levee. Where a cut-off is not provided or where it is probable that the cut-off will not eliminate all underseepage, it may be necessary to collect remaining seepage in a pervious trench. The trench may be installed with or without a drain pipe.

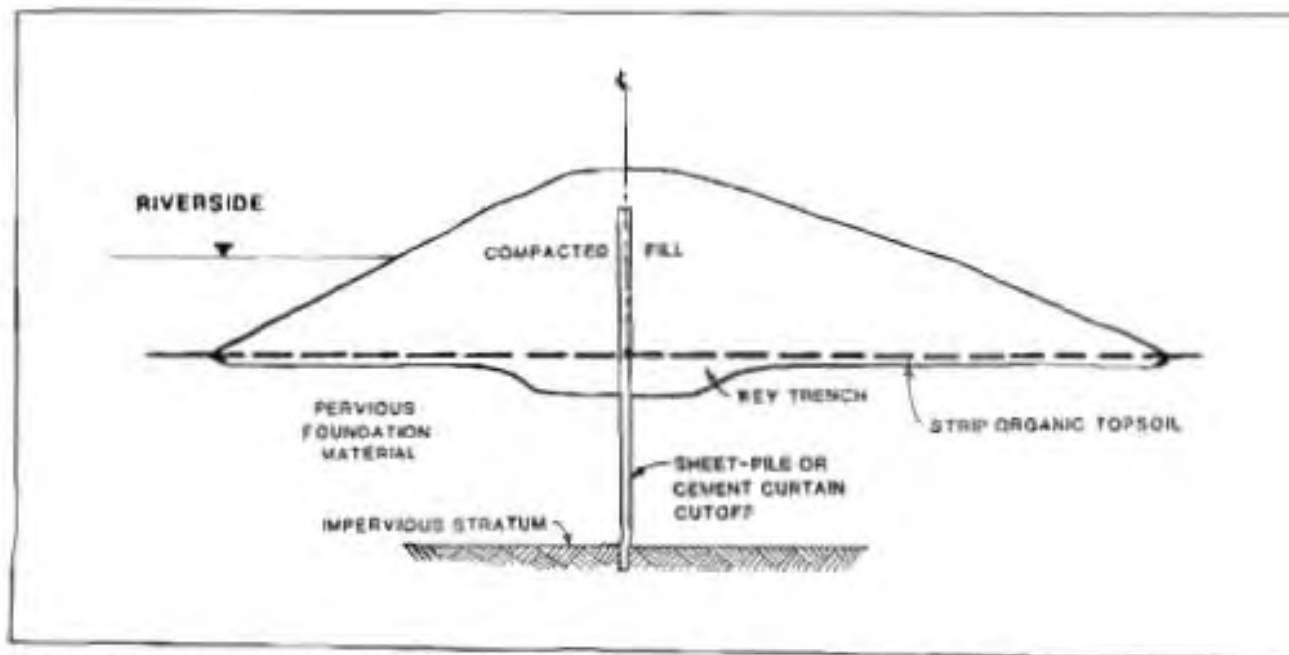

Figure III-41. Levee Underseepage Controlled By Sheet-Pile or Cement Curtain Cut-Off

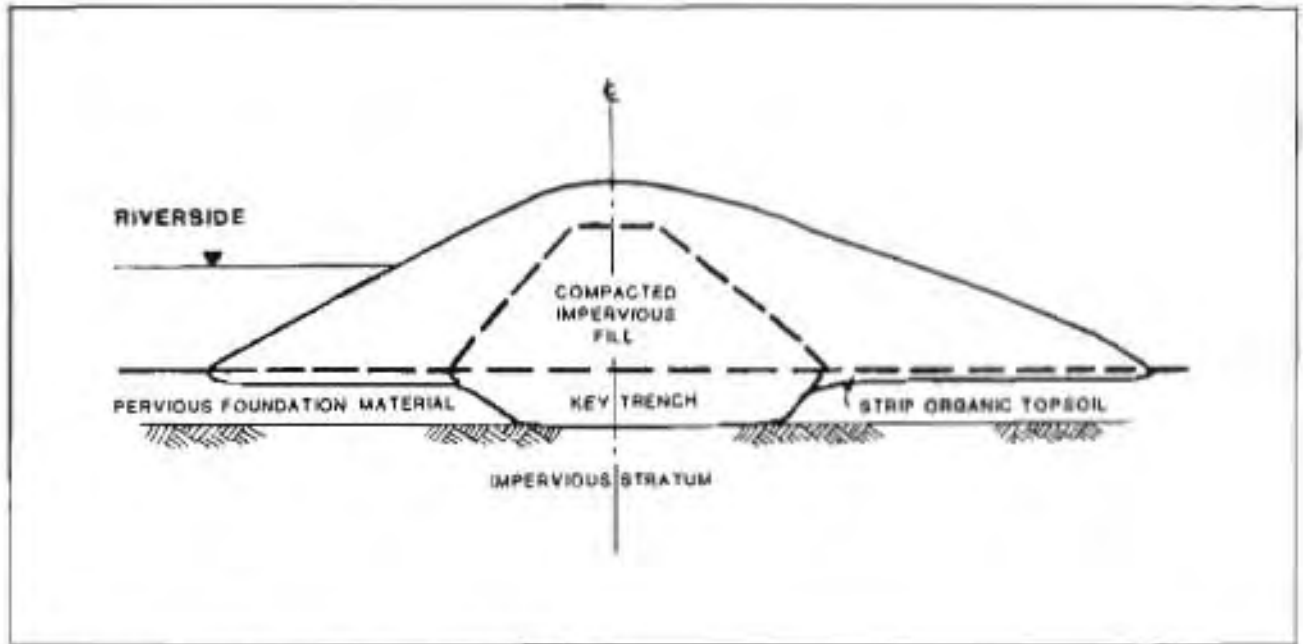

Figure III-42. Levee Underseepage Controlled By Compacted Impervious Core

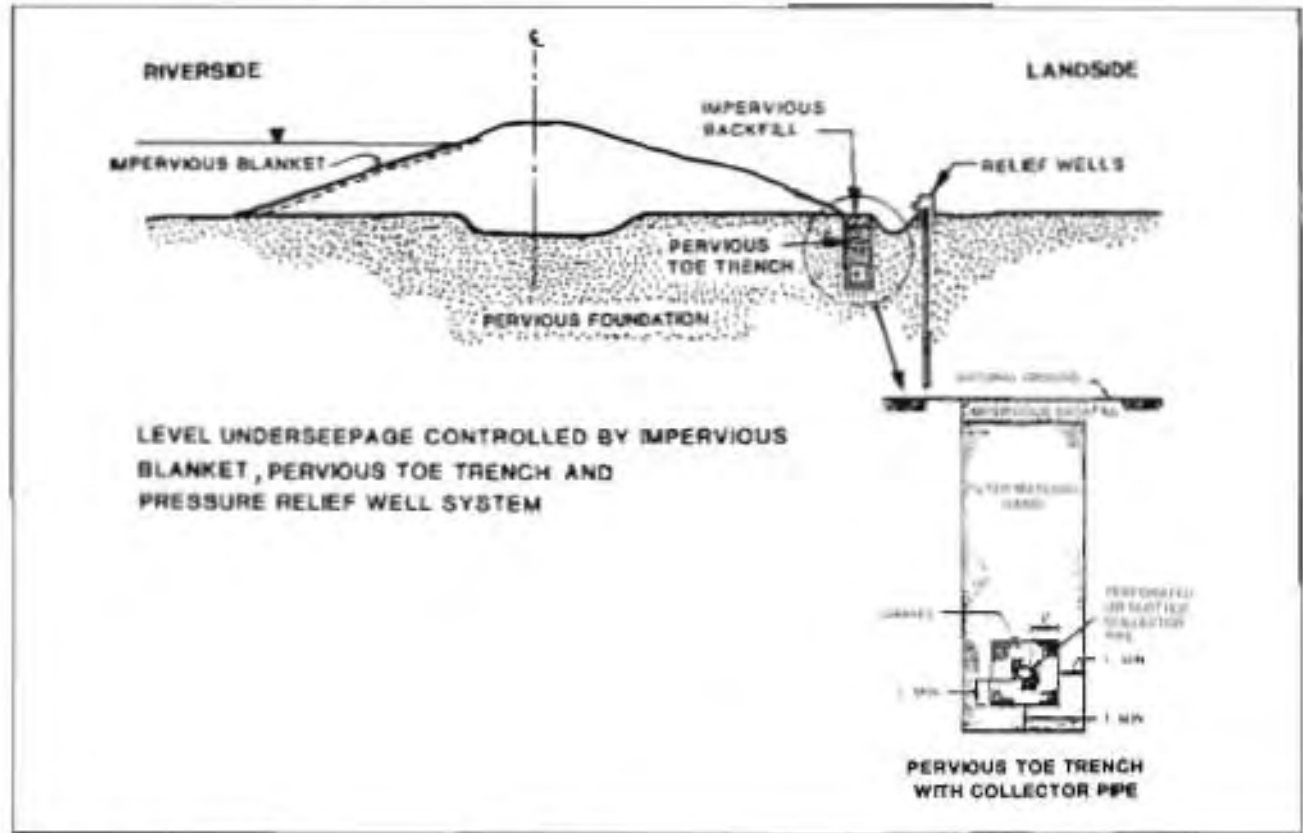

Figure III-43. Level Underseepage Controlled by Impervious Blanket, Pervious Toe Trench and Pressure Relief Well System

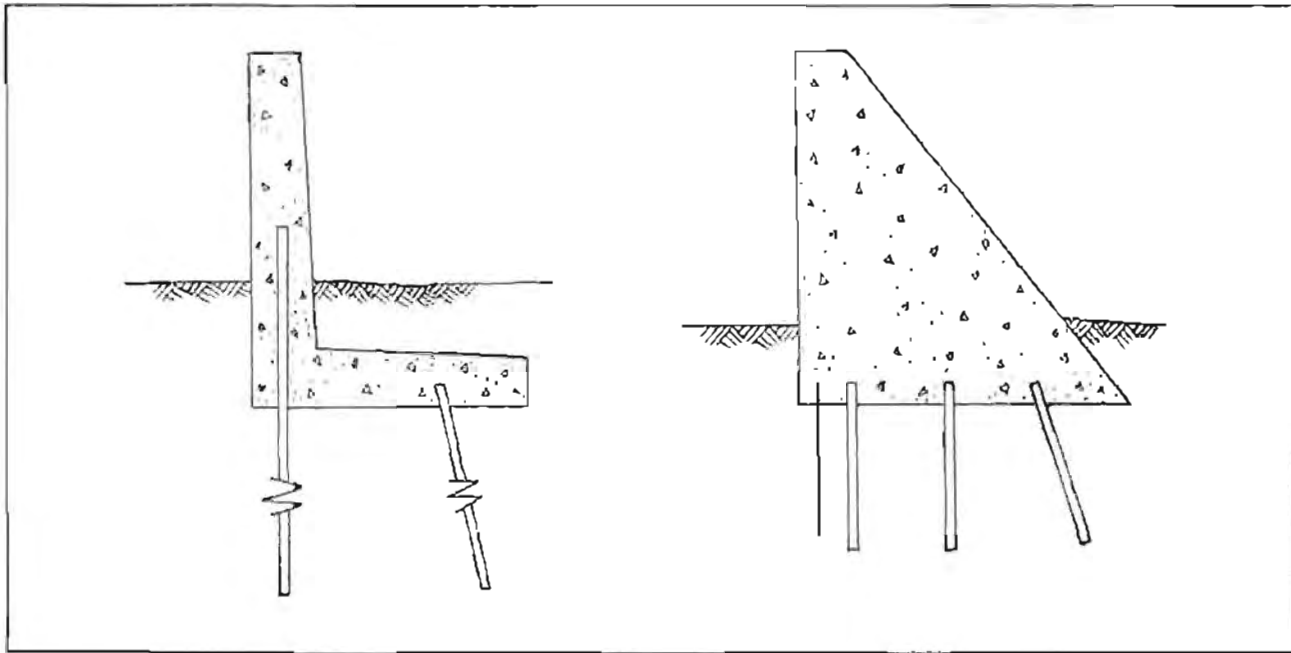

Figure III-44. Floodwall Underseepage Controlled by Sheet Pile or Cement Curtain Cut-Off

A pervious toe trench (Figure III-43) is effective for collecting underseepage where an underlying pervious stratum is thin (or where a cut-off has been used) and the trench can, therefore, intercept a large percentage of the seepage. For the case of thick underlying pervious strata, a blanket/toe drain system will be more effective in collecting deep seepage. Occasionally, it may be advantageous to locate the pervious trench towards the center of the levee system (Figure III-45) and to discharge intercepted seepage through a horizontal blanket drainage layer. There is some advantage to a location under the levee in that the trench can also serve as an inspection trench and because the blanket drain can help to control seepage that may occur through the levee embankment.

d) **Pressure Relief Wells.** Pressure relief wells may also be installed along the landside toe of a levee or floodwall system to reduce uplift pressure. These wells are designed to intercept and control seepage and associated hydrostatic pressures. They are particularly effective where pervious foundation strata are too deep to be penetrated by cut-offs. A relief

well system can be expanded if the initial installation does not provide adequate control. Wells require periodic maintenance and generally suffer loss in efficiency with time. This efficiency loss is caused by muddy surface waters, bacterial growth, or carbonate incrustation that tend to clog the well screens. Figure III-46 illustrates a typical pressure relief well.

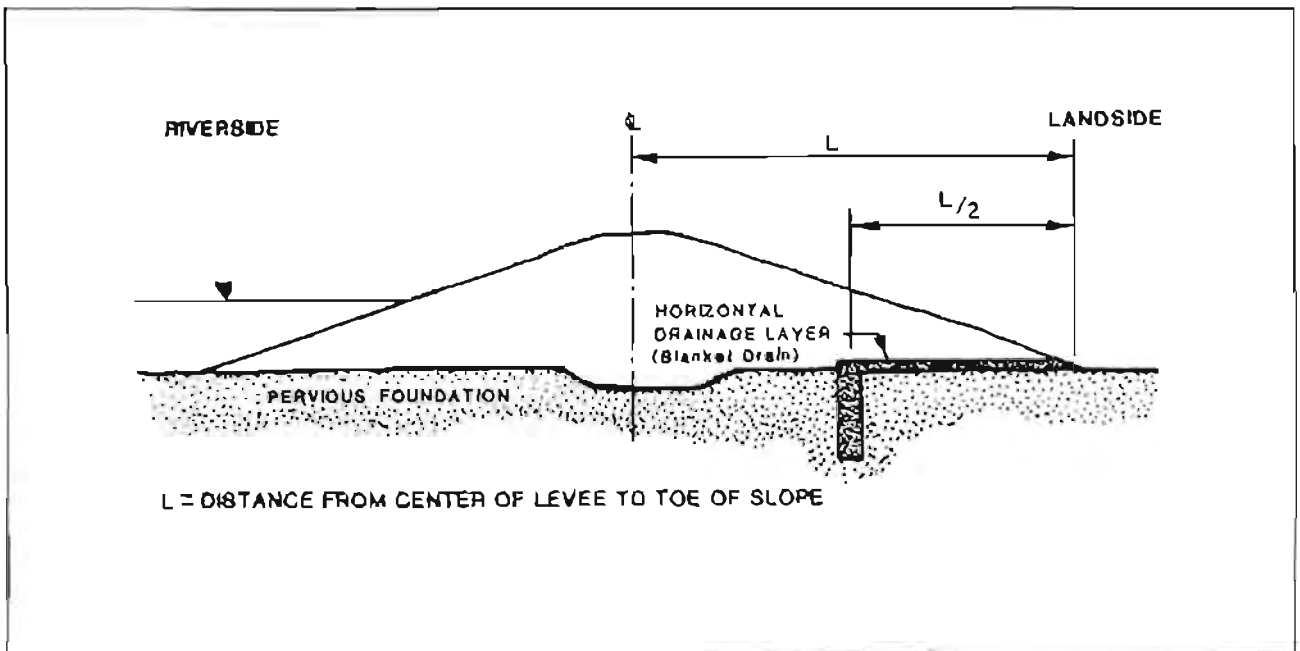

Figure III-45. Blanket Drain Beneath Levee

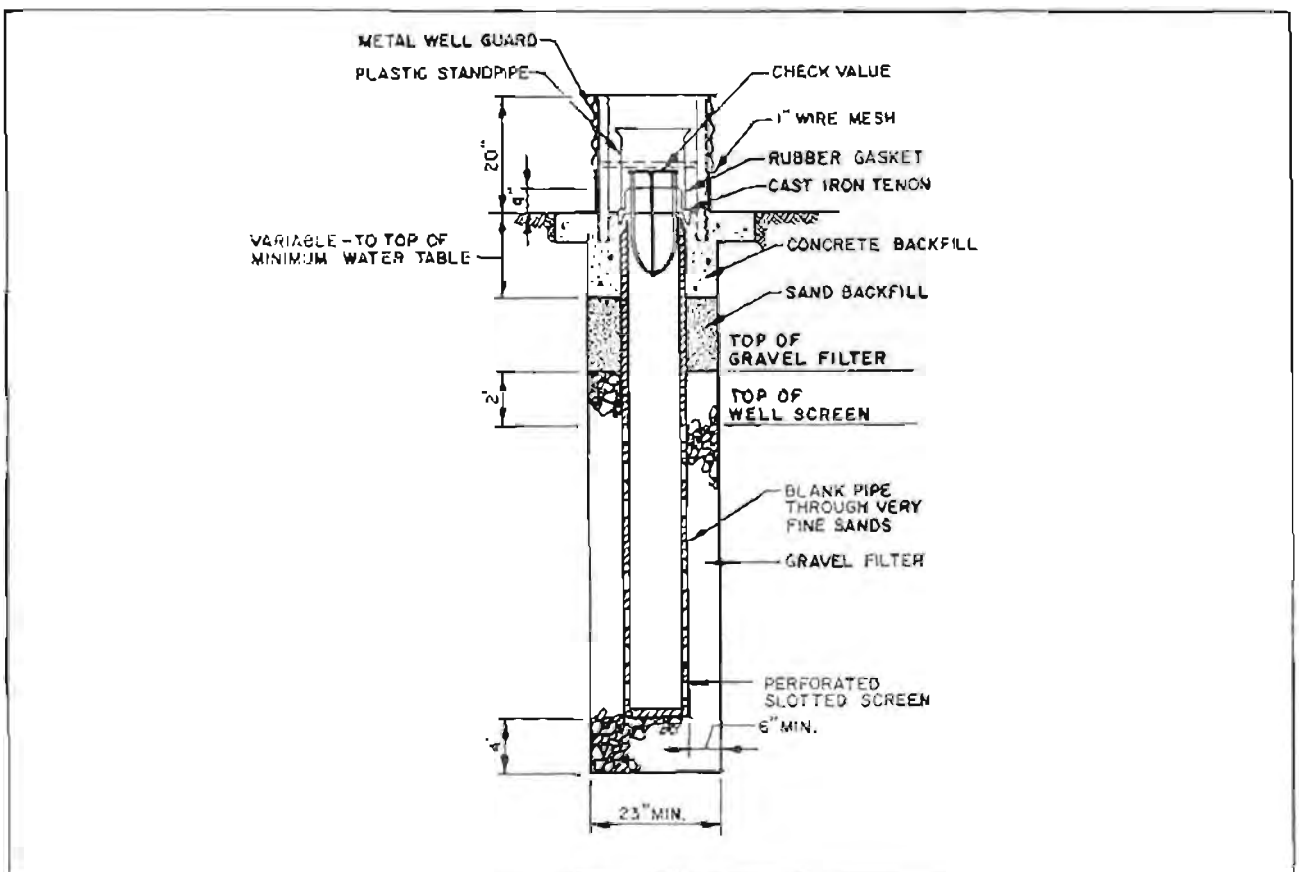
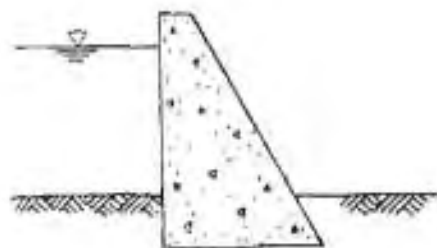

Figure III-46. Pressure Relief Well

Source: U.S. Army Corps of Engineers, Design and Construction of Levees. EM 1110-2-1013

5. FLOODWALL DESIGN. If it has been determined that an area would best be protected by the construction of a floodwall, a wide range of configurations, construction materials, and other variations are available. The design of any type floodwall, whether fixed or movable, must address two broad concerns: the overall stability of the wall as related to external loads, and the design of all wall features for sufficient strength as related to calculated internal stresses. (see Figure III-47).

a. Structural Design of Permanent Floodwalls. The stability of a floodwall (or any structure) can be defined as the ability to develop sufficient reactions to prevent gross movement under load. A structure may be strong enough to maintain its shape under load, but be unstable due to geometry or support conditions. A stability analysis of a proposed floodwall design includes consideration of overturning due to unbalanced moment, sliding due to unbalanced lateral load, and failure of the underlying soil due to high lateral and vertical loads. These three concerns are illustrated in Figure III-48.



GRAVITY WALL

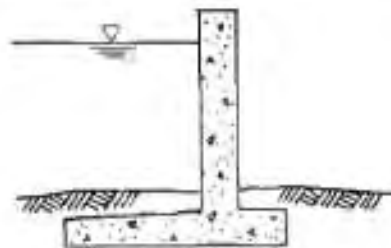

CANTILEVER WALL

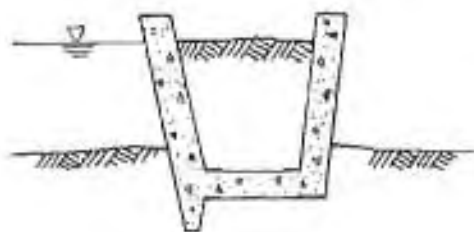

CELLULAR

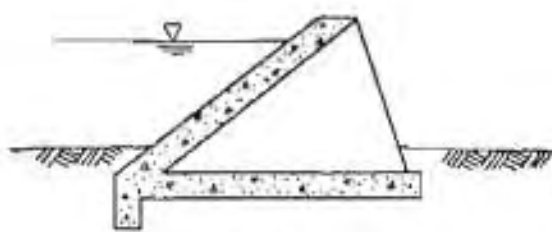

FLAT DAM

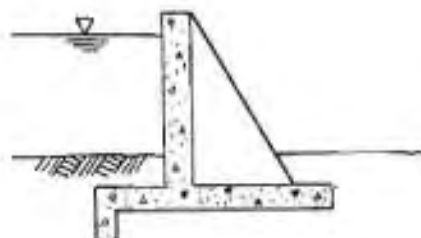

BUTTRESS

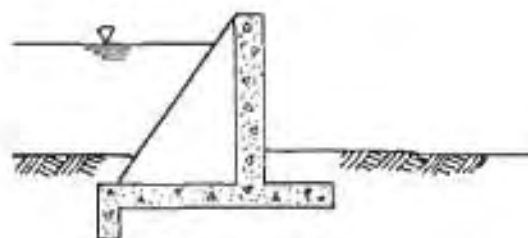

COUNTERFORT

Figure III-47. Various Floodwall Types

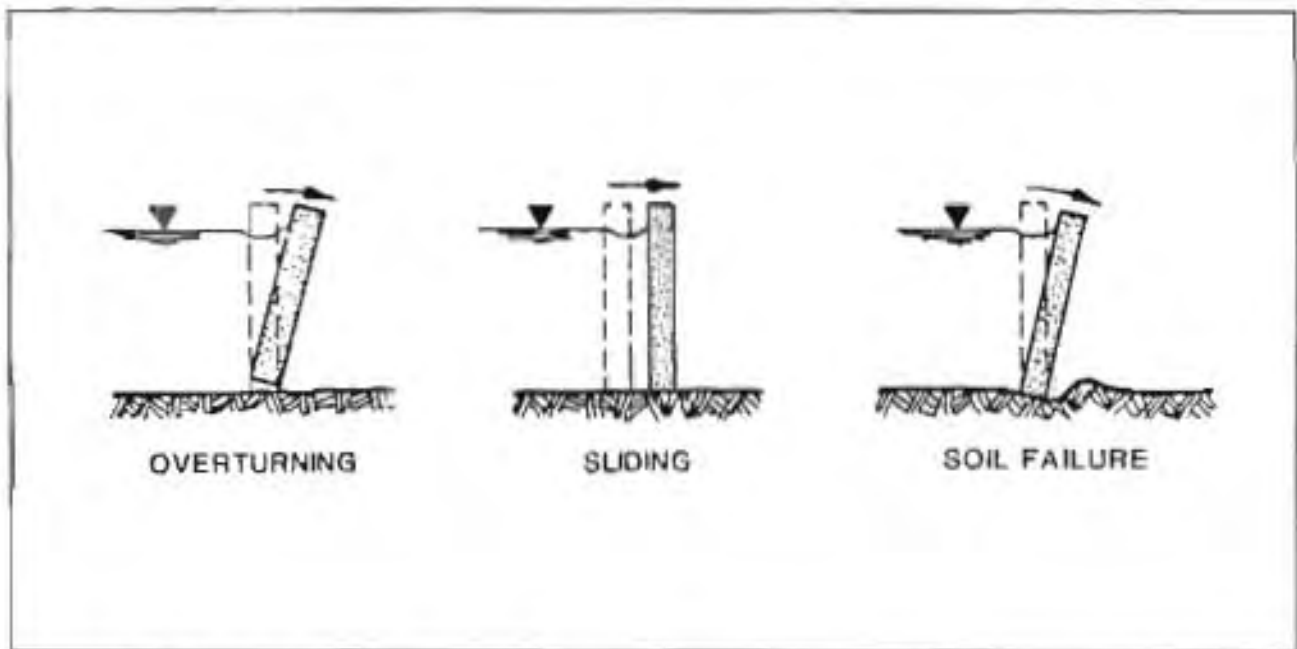

Figure III-48. Floodwall Stability

b. **Gravity Walls.** In designing the gravity wall, the stability of the structure and its supporting foundation materials represents the major design consideration. The structural stability of a gravity wall is attained through effective positioning of the mass of the wall rather than by depending on the weight of the retained materials.

The gravity wall resists overturning primarily by the dead weight of the concrete construction; it is simply too heavy to be overturned by the lateral flood load. To overturn the gravity wall illustrated in Figure III-49, the applied loading must cause the concrete to rotate about the lowest point of its axis on the side away from the load, and this movement is resisted by the concrete mass which tends to rotate the wall in the opposite direction (counterclockwise in the figure) about the same point. For a given wall height, more overturning resistance is added by increasing its top width (C) and/or its bottom width (L), which will increase the volume and weight of the concrete, or the distance from the center of mass of concrete to the point of rotation, or both.

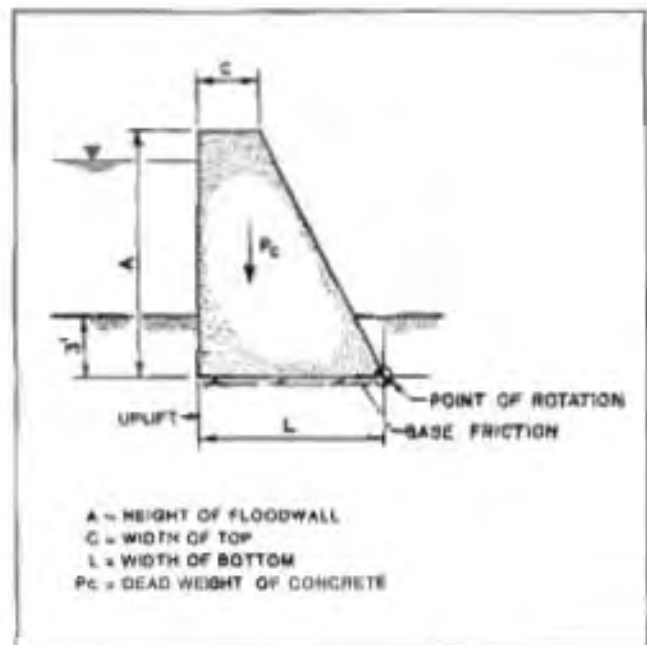

Figure III-49. Stability of Gravity Floodwalls

Sliding is generally resisted by frictional forces between the concrete base and the soil foundation.

The magnitude of this force depends on the vertical pressure between concrete and soil due to the weight of the wall, and on the size of the base area over which the friction acts. Sliding is further resisted by passive resistance, or resistance to displacement, or the soil mass behind the floodwall on the land side. Resistance to sliding in the gravity wall can be increased by increasing the volume and weight of the structure or by adding a shear key to the base of the wall.

Soil foundation stability is achieved by ensuring that the structure neither moves nor fails along possible failure surfaces including the surface bounded by the structure and the supporting foundation. Vertical contact pressure along the base of the wall on the underlying soil is caused by the wall dead load and any overlying soil or water, and also from overturning forces related to lateral loads. The overturning forces tend to cause higher contact pressures at points further from the wetted face of the wall. Two methods of controlling the resulting contact pressure are to increase the size of the base to spread the loads over a greater contact area, or to rearrange the geometry to minimize the effect of the overturning forces. This must be accomplished with due regard to satisfying the requirements of overturning and sliding. In areas where the floodwall must be founded on weak soil, the requirement for maintaining low contact pressure often governs the design of the wall.

In summary, gravity walls are appropriate for low walls or lightly loaded walls. They are relatively easy to design and construct. The internal stresses in gravity walls are low. Therefore, they may be constructed with minimal reinforcing if they are properly jointed. The primary disadvantage of gravity walls is that a large volume of concrete is required. At some point, it becomes more cost effective to use a cantilever wall. The cantilever wall (as discussed below) is more complex, but considerably less concrete is required. Therefore, cantilever walls are more cost effective for most floodwall applications.

c. Cantilever Walls. For gravity walls, the resistance to potential overturning can be increased not only by increasing the wall weight, but also by increasing the distance from the center of mass to the

point of rotation of the wall. The mechanism of the cantilever wall is an extension of this method of resisting rotation by reducing weight and extending the lever arm. In addition, the cantilever wall utilizes the potentially stabilizing dead weight of both soil and floodwater as these materials exert overturning forces on the structure.

For the cantilever wall shown in Figure III-50, a significant portion of the weight that contributes to stability is the weight of the water above the toe 'T' of the base. This effect is offset to some extent by uplift pressure caused by water seeping under the foundation. To effectively increase the resistance to overturning for a given height, the values for 'T' and 'H' must be adjusted to yield the desired stability while still satisfying soil pressure constraints. Soil pressure and the factors of safety against sliding and overturning are calculated in the same manner as described in the gravity wall discussion.

As mentioned above, the internal stresses in a gravity wall are low, due to the massive nature of the structure. Therefore, design for internal stress is not generally required for a gravity wall. The elements of a cantilever wall, however, are slender, and careful consideration of reinforcing and detailing is necessary. The wall stem section acts as a cantilever fixed at the base, and therefore, its depth is normally controlled by the bending force at this location and must be sized to safely carry all applied loads. Shear is another important consideration, particularly near the connection of the wall stem at its base, where a construction joint is usually located. Again, the wall stem must safely carry the full lateral load and be capable of safely transferring this load to the wall base.

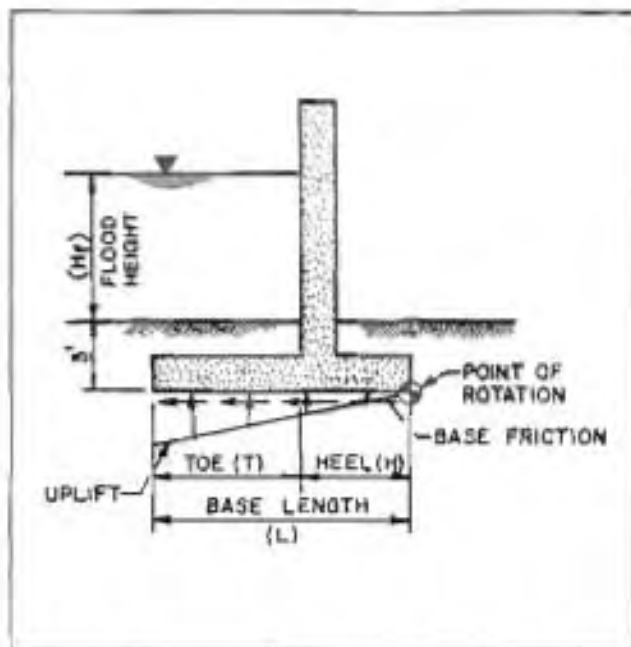

Figure III-50. Stability-Cantilever Floodwalls

To provide bending resistance against the applied loads, reinforcing bars must be placed toward the wetted face of the cantilevered stem. The shear is generally capable of being carried by the concrete cross section provided it has been properly proportioned according to ACI 318, Section II (American Concrete Institute, *Building Code Requirements for Reinforced Concrete*). When there is a construction joint between the base and the stem, as is usually the case to facilitate construction, a shear key or additional reinforcing bars must be provided to transfer the applied shear forces.

Prevention of water leakage through the hairline crack at the joint is generally provided by a waterstop. The arrangement of bars, etc., at the critical stem-to-base joint is shown in Figure III-51. Horizontal bars are designed for the wallstem section not to resist forces from floodwaters, but to control cracking of the concrete due to shrinkage, changes in volume due to temperature variations, and to provide integrity to the concrete.

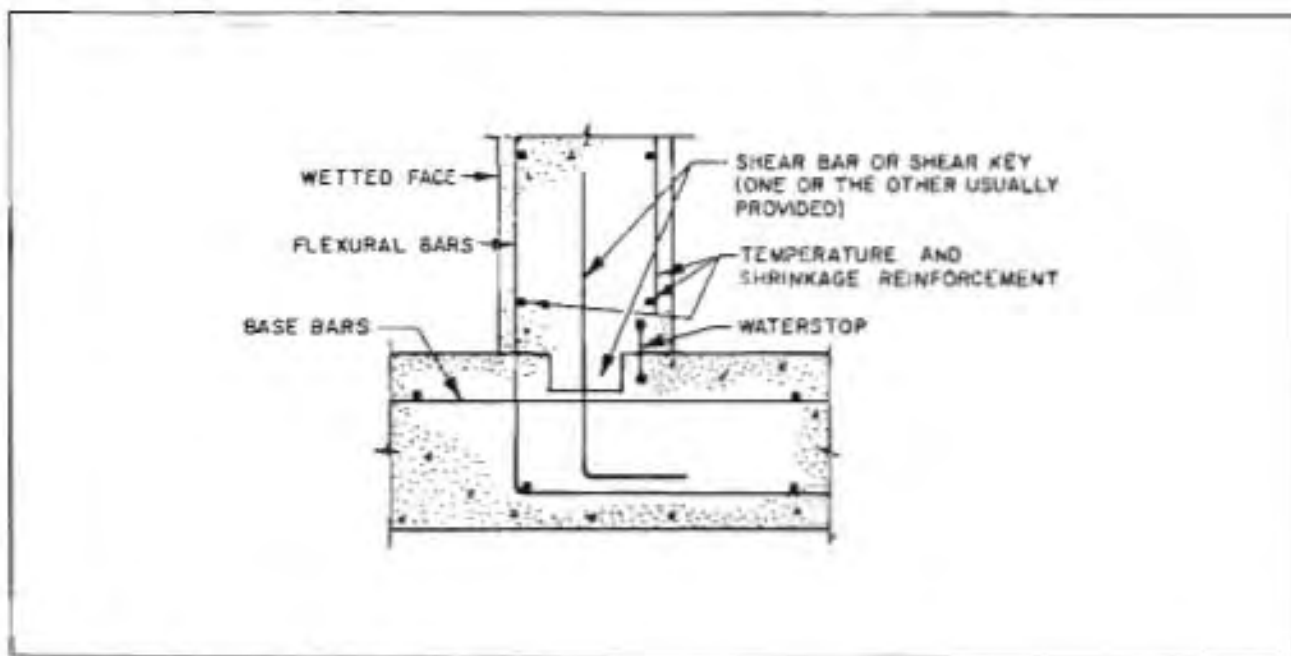

Figure III-51. Cantilever Wall Base

Shear and flexure in the concrete base are caused by the net effect of upward contact pressure and the downward weight of soil, water, and concrete. Although the relative effect of all forces varies from case to case, the usual situation is that concrete, submerged soil, and floodwaters tend to bend the toe downward while the contact pressure along the heel tends to bend this portion upward. Reinforcing steel must therefore be placed at both the top and bottom in the base. Shear forces are also considered and must be carried by a properly proportioned concrete section. In extreme cases, shear reinforcement can be provided in the base, but usually it is more cost-effective to simply thicken the base.

In summary, cantilever walls are commonly used to resist flooding and other lateral loads and their mechanism is well understood by engineers. Their use in resisting floodwater is almost always appropriate, particularly where a fairly high wall is required. In areas where foundation soil conditions are poor, the cantilever wall is a good choice because contact pressures are more readily controlled than with the use of a gravity wall. In very poor soil conditions, the base may be supported on drilled piers or piles to provide additional resistance against soil failure. The cantilever wall is a more complex structure to construct than the gravity wall, which could be an important consideration, especially in areas where the number of experienced contractors and craftsmen is limited.

d. **Movable Walls.** Figure III-52 illustrates two types of movable floodwalls. Wall sections may be either steel or concrete. The design of the footing requires the same considerations discussed above for permanent walls.

The movable wall is supported at both the top and the bottom. This is done to prevent rotation and allow easy assembly and removal. For walls of equal heights and loads, a simply supported removable wall panel will withstand a greater maximum shear and bending movement than will the fixed cantilever wall. Because of the support provided by the struts at the top, movable wall panels may be more lightly constructed.

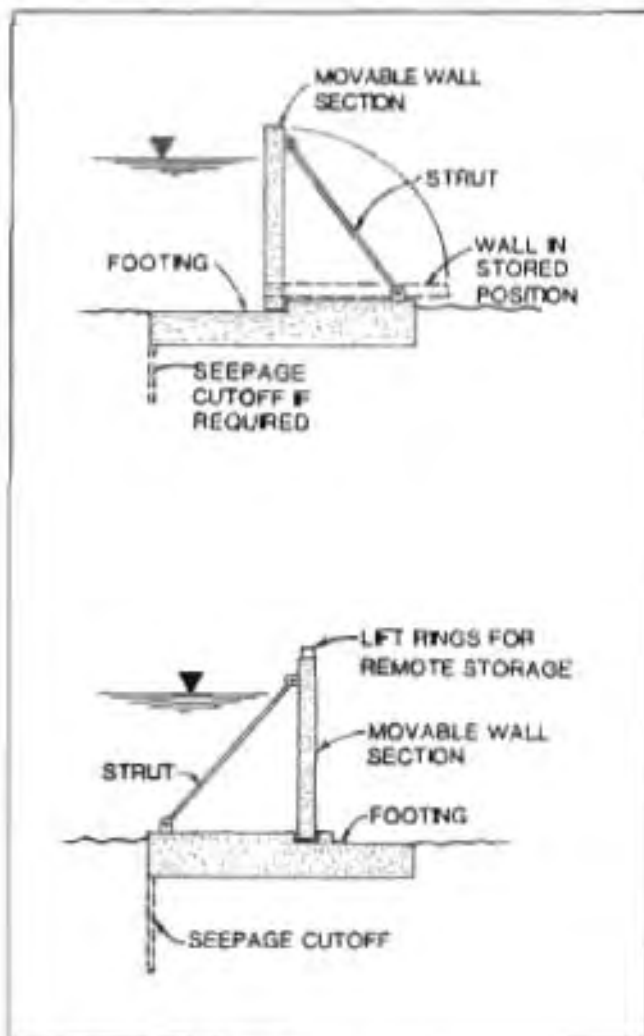

Figure III-52. Movable Floodwalls

Dry side strut construction is preferred because the struts are better protected and may be easily repaired or reinforced. If wet side struts are required, they should be of larger size to provide a safety margin against damage from floating debris.

6. LEVEE DESIGN. A levee is constructed of suitable fill material that is placed and compacted in layers to form a stable barrier to floodwater. Levees must be designed to have adequate strength and stability to resist all applied loads up to the designated protection level. For preliminary design purposes, the analysis of a levee may be divided into several critical components including (a) seepage and interior drainage control, (b) slope stability, (c) borrow area design, and (d) erosion protection. Seepage and interior drainage control have been covered in part 3 of this section. Therefore, the following presentation will be limited to items b, c, and d as listed above.

a) Slope Stability. Slope stability of an earth fill or levee embankment may be defined as the resistance of a given embankment to soil slippage or a tendency to move to a more stable (flatter) slope angle. Slope stability analysis techniques may be used to ensure that a given embankment will satisfy suitable safety

factors. The 'safety factor' is generally defined as the ratio of all stabilizing (resisting) forces to the driving forces (the forces tending to cause movement). The slope on the verge of failure is considered to have a safety factor of 1.0. For normal loading cases, an acceptable safety factor would be between 1.3 and 1.5. For extreme loading cases, it may be as low as 1.1. The stability analysis should be performed for the worst case loading conditions that are expected to develop.

Two modes of shear failure must be investigated: the rotational slide (Figure III-53) approximated by circular arc, and the translatory slide (Figure III-54) that occurs along a definite plane of weakness near the base of the embankment.

Figure III-53 illustrates a cross section of a sliding soil mass along a curved surface (rotational failure surface). The sliding tendency is developed by the moment of the mass about the center of the arc as shown. This moment is opposed by the total shearing resistance developed along the assumed sliding surface. Of course, when all available resistance is overcome, a progressive failure occurs.

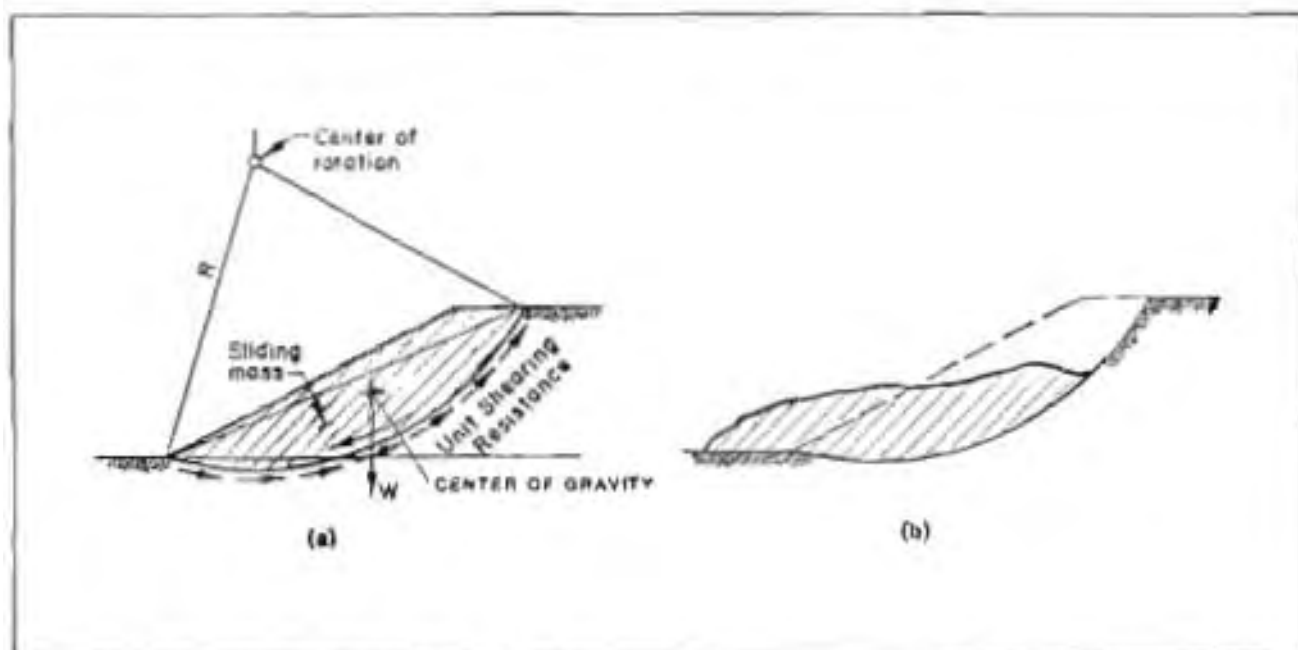

Figure III-53. Characteristics of a Rotational Slide
(Toe Slope Failure in Uniform Soil)

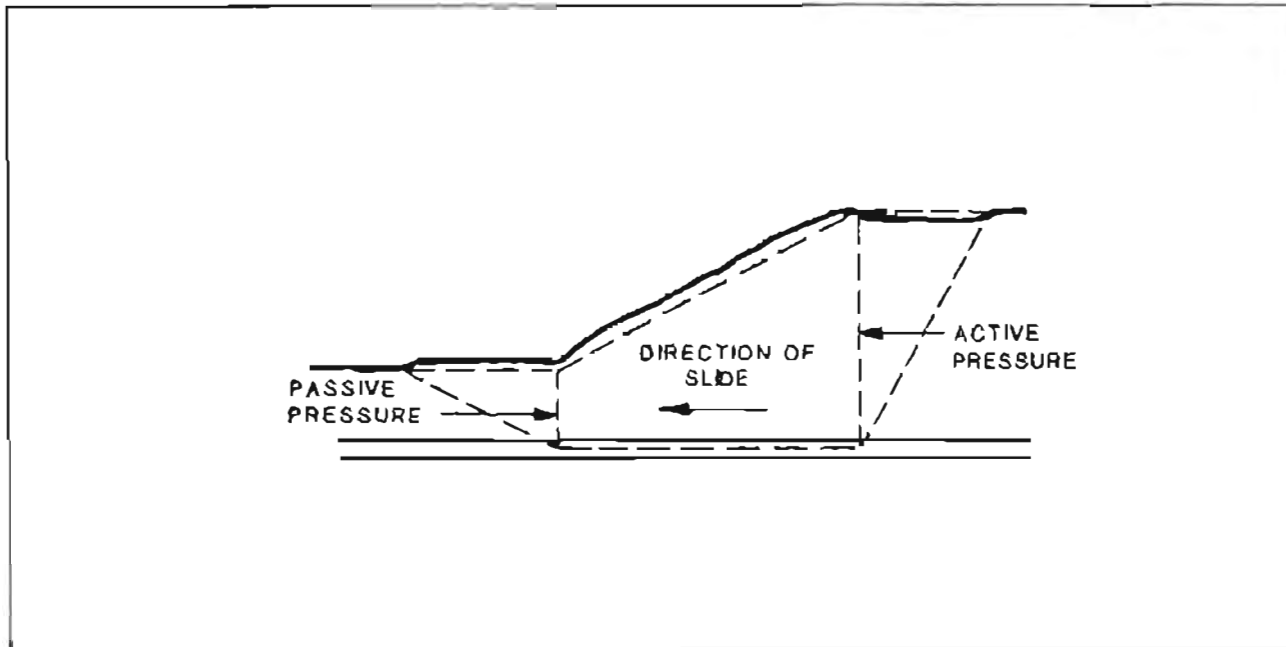

Figure III-54. Translatory Slide

Sophisticated numerical procedures, usually involving possible curved failure surfaces, have been proposed for evaluating the rotational slide. Due to the uncertainty in estimating the physical parameters of the material used in levee construction, however, use of these methods is rarely justified. The simple Swedish Slide Method or the Modified Swedish Method (method of slices), among others, provide acceptable analysis techniques. Most geotechnical engineering firms have access to computer programs that can quickly evaluate embankment stability if a detailed analysis is required.

For more detailed information relating to slope stability analysis and other embankment design considerations, the reader is encouraged to refer to *Design and Construction of Levees*, EM 1110-2-1913 as published by the U.S. Army Corps of Engineers. However, for preliminary design and cost estimating purposes a slope stability analysis is not generally required if standard slopes are maintained. The steepest slope that should be considered without detailed studies is a 1:2 slope ratio (1 vertical unit to 2 horizontal units). Where conventional mowing equipment is to be used to maintain the embankment, slopes should generally not exceed a 2:5 slope ratio.

Riverside slopes may be less steep than the ranges presented above if erosion damage from waves or high velocity floodwaters is anticipated.

b) **Borrow Area.** The selection of an appropriate borrow location often represents a critical factor in determining the applicability and economic feasibility of floodproofing with a levee. Factors that must be considered in the selection of a borrow area include the type and quantity of material available, distance from the levee site, land value, and environmental impacts. At sites where the borrow area is located in close proximity to the proposed levee, the designer must also evaluate any direct impacts that the borrow area may impose on the stability or impermeability of the levee. Because most soils are suitable for levee construction (except wet fine-grained or highly organic soils), accessibility and proximity usually represent the controlling factors in the selection of borrow areas.

Normally, long shallow borrow areas located some distance riverward of the proposed levee alignment present the optimum location for the borrow area (Figure III-55). However, landside pits are acceptable; and near urban areas, large centralized borrow areas are often established. It is generally

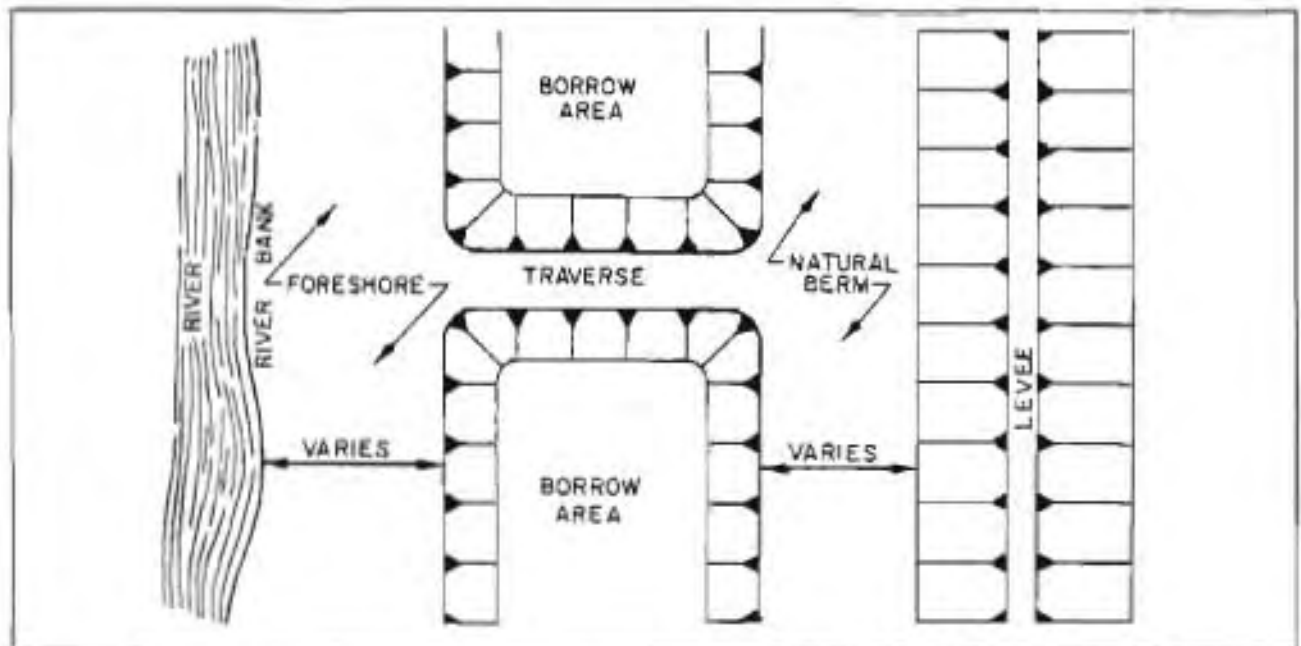

Figure III-55. Typical Levee and Borrow Areas

Source: U.S. Army Corps of Engineers, Design and Construction of Levees, EM 1110-1913

preferable to have 'wide and shallow' borrow pits as opposed to 'narrow and deep'. Side slopes should be relatively flat to avoid stability and erosion problems.

When using centralized borrow pits near the levee, an adequate thickness of impervious cover should be left over underlying pervious material. It is recommended that a minimum of two feet of impervious cover be left in place, and for landside pits the cover thickness should be adequate to prevent the formation of boils. The final borrow area should be graded for positive drainage and landscaped as required for aesthetic purposes and to protect against erosion.

c) **Erosion Protection.** Some form of erosion protection will be required on the riverside slope of an earth fill embankment or levee to withstand the scouring and impact forces of waves and stream currents. This protection can be provided by grass cover, gravel, asphalt paving, concrete mats, or riprap. Riprap is the most common protective cover when it is determined that vegetative cover will not be adequate. Factors that should be considered in selecting appropriate erosion protection material include:

- **Velocity of Floodwaters.** Riprap protection should be considered if stream velocities are expected to exceed 5 feet per second.
- **Protective Barriers.** An embankment may be protected from severe erosion by dense stands of vegetation or other features that reduce wave impact or stream velocity.
- **Wind Velocity and Fetch.** The severity of wave action is generally related to anticipated wind velocity and the length of the water body that is exposed to the wind (fetch). In general, riprap should be used if the 'fetch' is greater than 1,000 feet at the design flood level.
- **Embankment Slope.** The slope of the embankment has an influence on the susceptibility of the structure to erosion. In general, flatter slopes are subject to less erosion damage than steep slopes.
- **Levee Alignment and Materials.** The characteristics of the embankment construction materials and the alignment of the embankment in relation to wave impacts, and moving floodwaters also have a significant effect on erosion potential.

For preliminary design and estimating purposes, a riprap layer that is 1 foot thick with a maximum stone size of 150 lbs. is considered to be adequate for most situations. The riprap should have a smooth size distribution with a median rock size of about 25 pounds (eight inch diameter), with 80% of the rocks larger than four inches in diameter and ranging down to gravels. With a distributed size range, the spaces formed by the larger stones are filled with smaller sizes which prevents the formation of open pockets. Angular stones are more suitable for riprap than rounded stones. The rock should be hard, dense, and durable to withstand long exposure to weathering. Rock should be dumped directly from trucks to minimize segregation of rock sizes. If further refinement is desired, the reader may refer to Figures III-56 to determine specific stone size requirements; and to Figure III-57 to determine the volume of riprap material that would be required for a particular embankment.

7. MAINTENANCE. Floodwalls and levees should be inspected annually for structural integrity. Following a flood, the structures should also be examined for scour and erosion damage. Depending upon the adequacy of the original levee protection, it may be necessary to replace riprap or increase the level of erosion protection. If excessive scour occurs, consideration should be given to landscaping features or the construction of flood flow diverters or barriers near the upstream side of the structure to reduce flood velocities and the associated impacts of scour and debris accumulation.

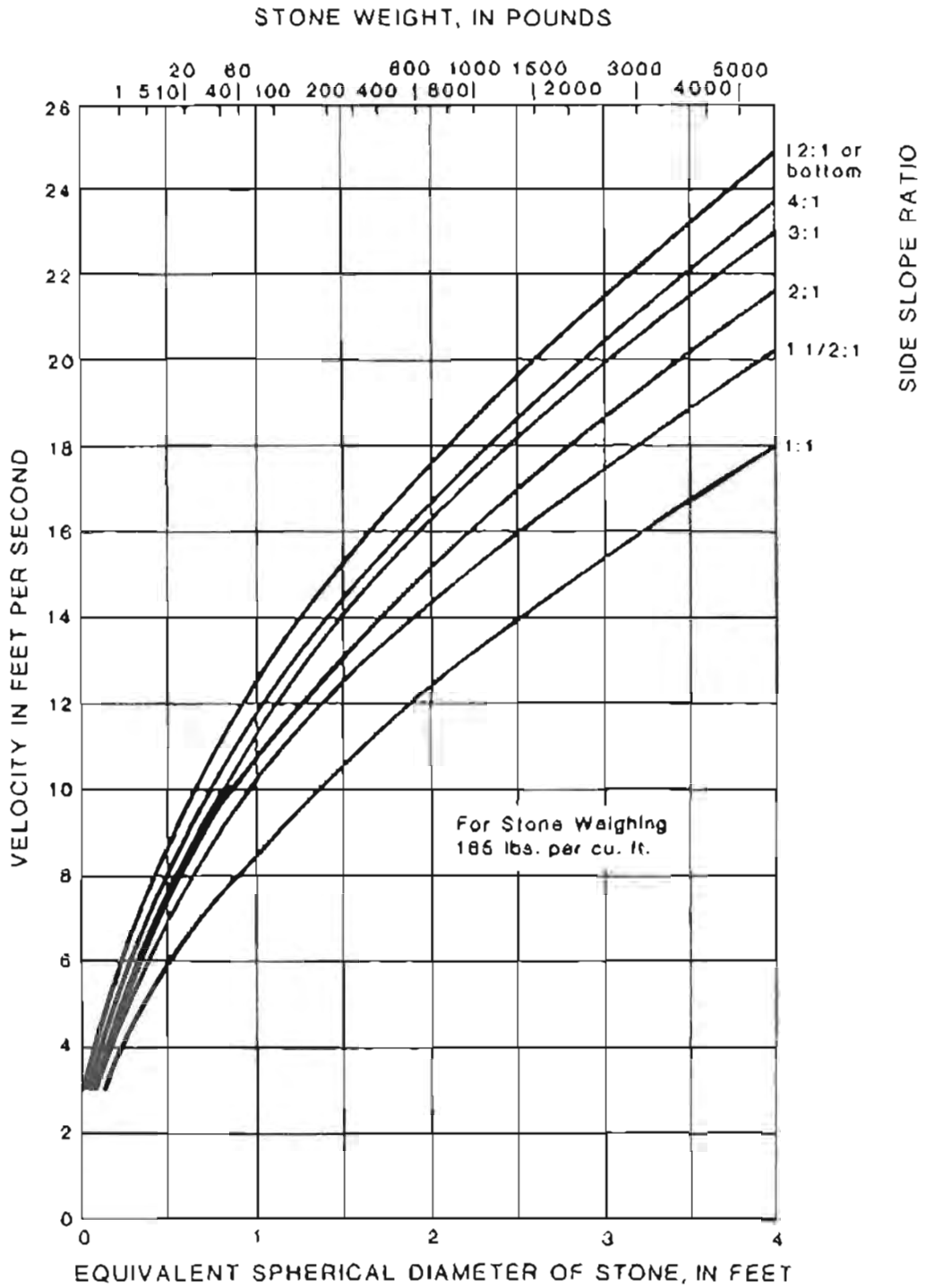

Figure III-56. Size of Stone That Will Resist Displacement for Various Velocities and Side Slopes
 Source: Adapted from Subcommittee Report on Slope Protection, American Society of Civil Engineers Proceedings, June, 1948

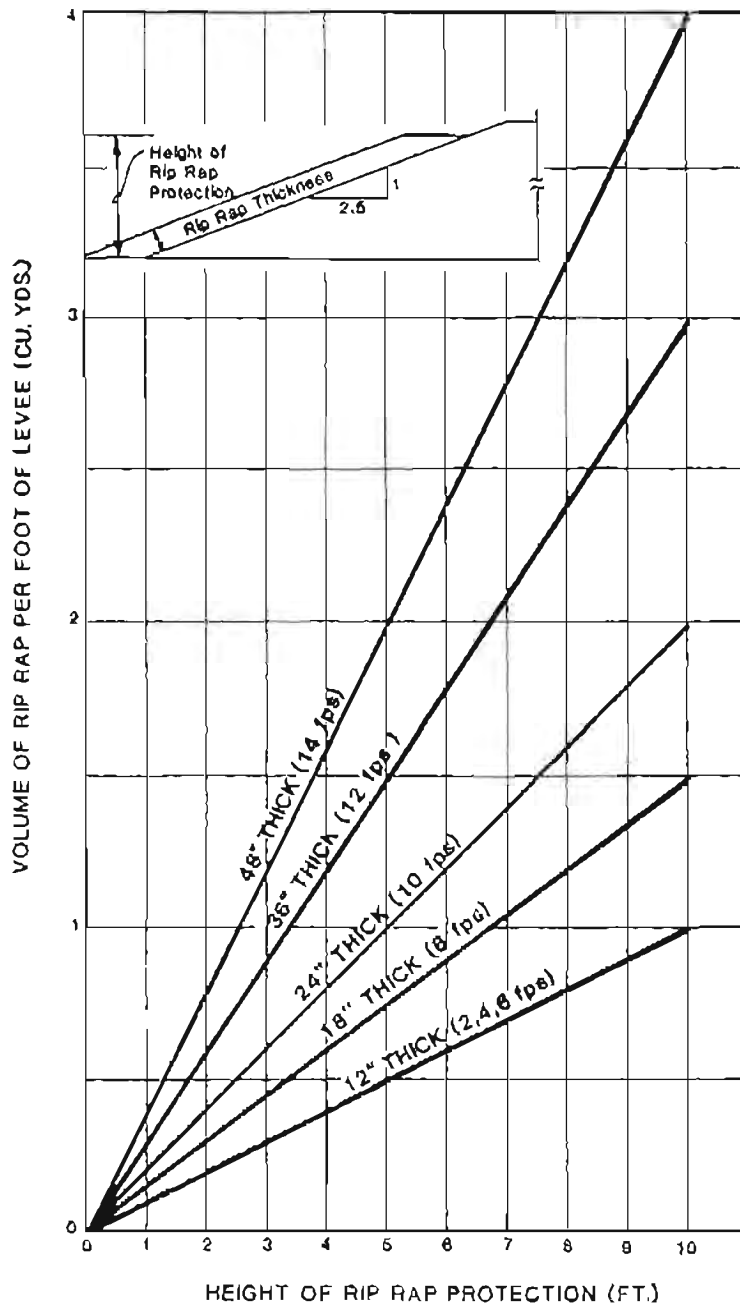

Figure III-57. Volume of Rip Rap Required Per Linear Foot of Embankment for Various Embankment Heights and Stream Velocities

CHAPTER IV



OTHER FLOODPROOFING MEASURES (Emergency and Other Non-Permanent Actions)

A. EMERGENCY MEASURES

Emergency floodproofing includes techniques that can be initiated on relatively short notice using stored and/or natural materials to prevent flooding. Emergency methods that will be presented in this section include sandbag dikes, earthfill crib retaining walls and stop log barriers. The use of stop log barriers might be considered a contingent technique (Chapter III). However, the installation and the type of protection offered by these barriers is similar to that of the sandbag dikes and earthfill crib retaining walls. Therefore, all three techniques are presented in this section.

Although most of the construction activities related to emergency methods do not generally begin until a flood warning has been issued, emergency actions must be planned in advance. These plans must address material storage and maintenance, labor and equipment requirements for the installation of emergency barriers, and labor force training.

The primary advantage of an emergency method is the relatively low implementation cost. Natural materials such as sand, soil, and timber and the labor and equipment required to place these materials are all that is required. These methods are capable of providing an acceptable level of flood protection in areas characterized by low water velocities and shallow depths and, most importantly, where floodwaters rise so slowly that there is time to install emergency flood barriers. The availability of emergency floodproofing materials also provides flexibility in controlling unexpected circumstances such as overtopping of an existing levee by a flood that exceeds the design capacity of that levee.

The principal disadvantage of emergency measures is that sufficient advance warning is required to mobilize personnel and install emergency barriers. Most emergency floodproofing methods require an extensive labor force that must be available on relatively short notice. Other emergency measures depend on the availability of heavy machinery and trained operators. If the magnitude or rate of rise of a flood are misjudged, plans to protect a facility with emergency floodproofing techniques may fail.

Another disadvantage of some emergency methods is that a large amount of construction material must be stored on or near site to be protected. This represents a pronounced drawback for small sites and for sites where aesthetic values must be considered. Also, *emergency measures do not satisfy the minimum requirements for watertight floodproofing as set forth by the National Flood Insurance Program.* This is especially applicable to the protection of existing construction.



B. TYPES OF EMERGENCY MEASURES.

1. **SANDBAG DIKES.** A sandbag dike is the emergency flood protection method most frequently used. Sand is available at many locations and is relatively inexpensive. Sandbags may be fit to the irregularities of the area where they are placed. However, bags may be filled with soil if sand is not available. If soil fill will be required, excavating equipment (dozer, backhoe, etc.) should be available to remove sod, loosen the soil, and transport the material to the work site. Performing these tasks by hand requires much time and labor.

Bags should be strong enough to hold approximately one-third cubic yard of material and to withstand prolonged contact with water. Bags that are manufactured specifically for floodproofing are available in both burlap and plastic. Webbed polypropylene bags are often preferred because of their strength and resistance to wear. Feed bags and bags used for peat moss, bark mulch, etc. have also been effective when filled and placed in an appropriate manner.

For sandbagging to be effective, it is essential that required materials and equipment must be nearby in a location that will not be isolated from the site by floodwaters. In addition, an adequate work force must be available to fill and place the bags.

A recommended method for construction of a sandbag dike is shown in Figure IV-1. As shown, the first step involves removing the sod and excavating a bonding trench at least one bag deep and two bags wide. This will reduce seepage under the dike. The bags should be filled about one-half full. It is not necessary that the bags be tied. The bags in the trench and the first layer of bags should be placed parallel to the channel with bags in each line overlapping as shown in Figure IV-1. The second layer is placed perpendicular to the first, the third parallel to the first, and so on with each succeeding layer. For lateral stability, the dike should be about two to three times as wide at the base as it is high. If time allows, a polyethylene plastic sheet may be incorporated in the dike to provide extra protection against seepage.



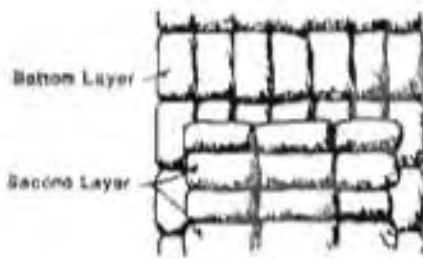
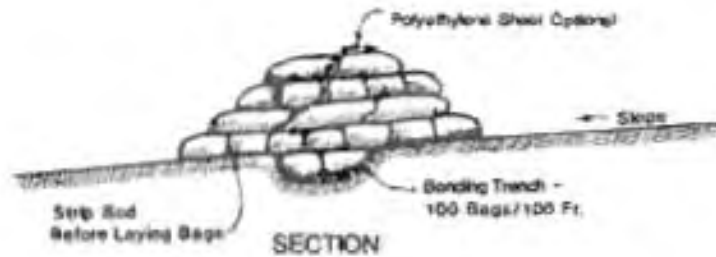

PLAN



METHOD OF LAPPING SACKS

Notes:

1. ALTERNATE DIRECTION OF SACKS, I.E.: BOTTOM LAYER PLACED LENGTHWISE PARALLEL TO THE SLOPE; NEXT LAYER PLACED PERPENDICULAR TO FIRST, ETC.
2. LAP UNFILLED PORTION UNDER NEXT BAG.
3. TYING OR SEWING OF BAGS IS NOT NECESSARY
4. BAGS SHOULD BE APPROXIMATELY ONE-HALF TO TWO-THIRDS FULL.
5. TAMP THOROUGHLY IN PLACE.

MATERIALS REQUIRED FOR 100 LINEAR FEET		
Height Above Ground	Approx. Bags Required	Cu. Yds.
1 Ft.	600-800	10-13
2 Ft.	1400-2000	23-33
3 Ft.	2200-3400	37-57
4 Ft.	5300	88
5 Ft.	7800	137
6 Ft.	10000	167

Figure IV-1. Sandbag Dike Construction Techniques

Inflatable water hoses or mud-filled hoses may provide an alternative to sandbag dikes. With the mud-filled hose, a strong polyester hose of fixed dimension, with part of its skin perforated, is extended to any required length and filled with a mixture of mud or sand and water from the stream bottom by pumping through self-sealing inlets. Excess water is then drained through the perforation, leaving a compacted soil in the hose (Figure IV-2). The filling time depends on the soil content of the pumped mixture. For example, it is estimated that a wall 2.8 feet high and 1,000 feet long may be erected in three hours when four pumps (1,000 gpm each) are used to pump a mixture of 20% soil and 80% water into the hose. The height of the wall can be increased by laying additional hoses on top of each other.

Although water-filled hoses have been used in Europe for major structures, the application of mud and/or water-filled hoses as effective flood barriers for commercial structures in the U.S. has not been thoroughly demonstrated.

2. EARTHFILL CRIB RETAINING WALL.

Earthfill cribs or retaining walls may also provide effective emergency flood protection. An earthfill crib is formed by setting two lines of posts parallel to the

stream channel, nailing boards to the inside of each row, and bracing posts across from one another with a plank or wire (Figure IV-3). After the crib is formed, it is filled with soil which may be excavated near the site. Water resistance can be improved with the addition of a polyethylene plastic sheet as shown in Figure IV-3.

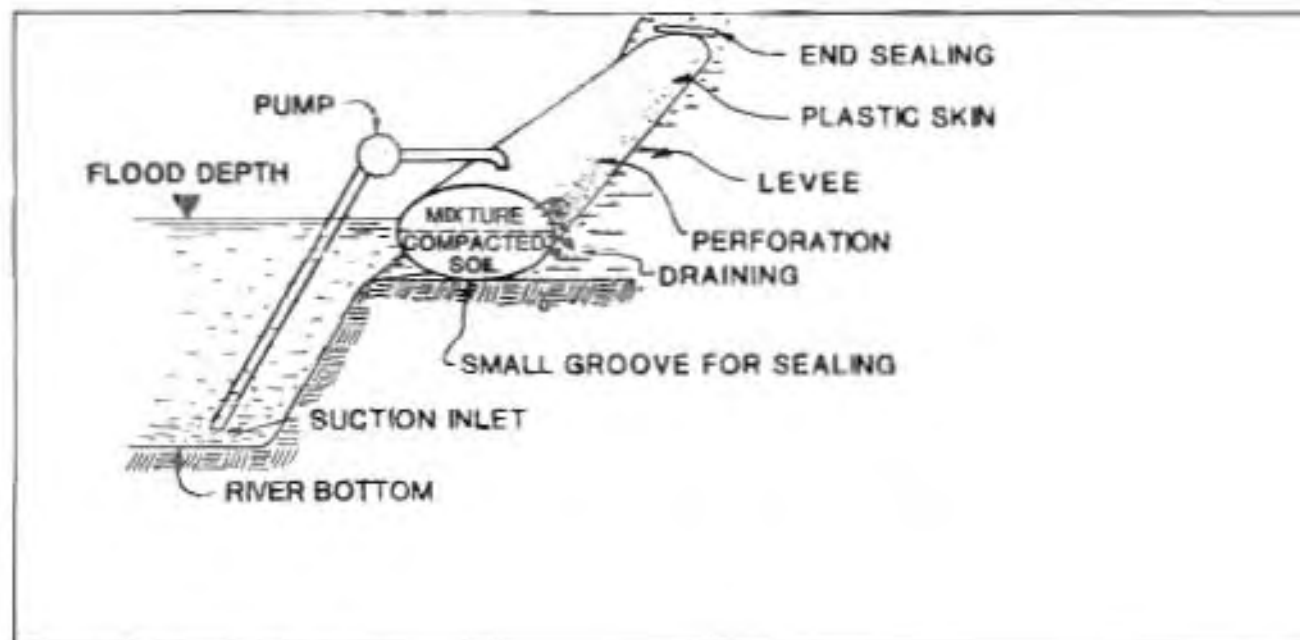

Figure IV-2. Mud Hose Profile

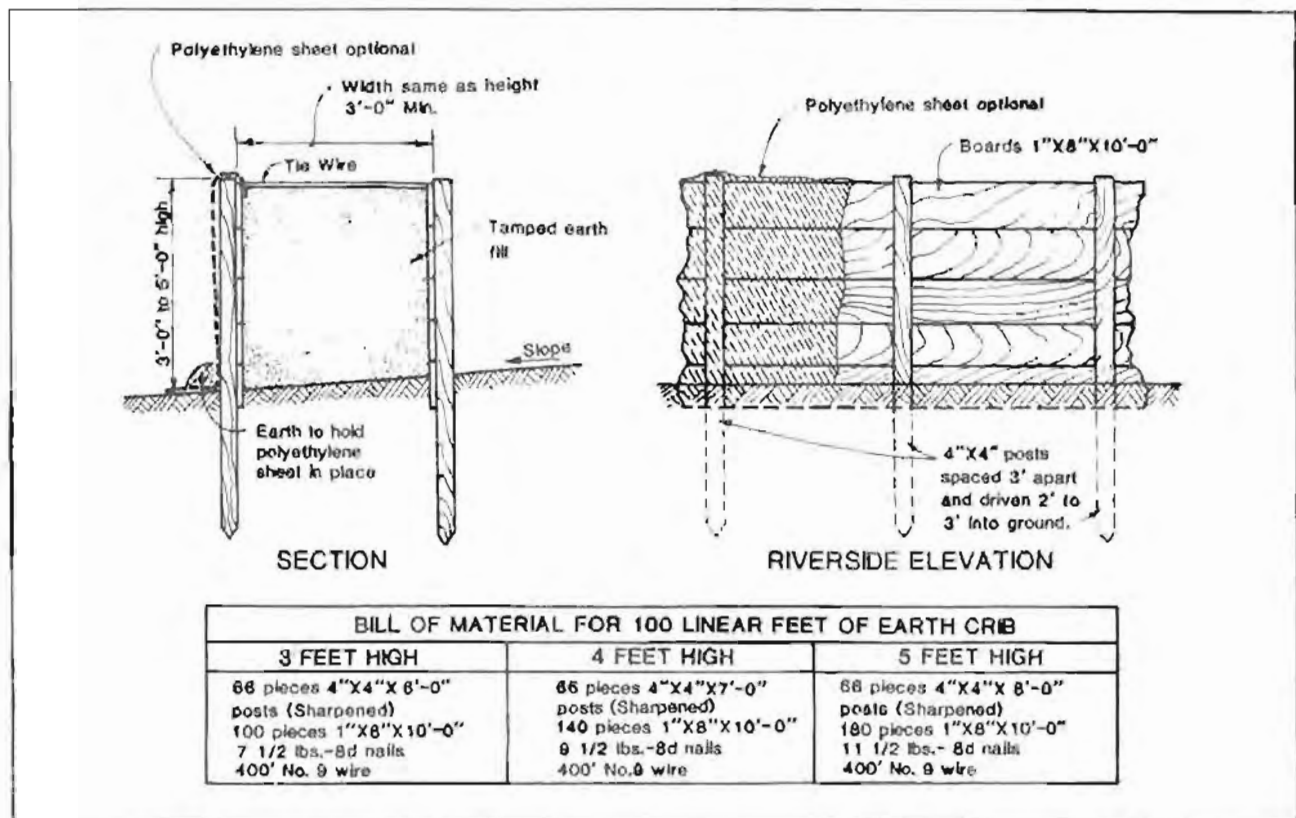

Figure IV-3. Earthfill Crib Retaining Wall

A variation of this procedure is the earth and timber retaining wall. For this technique, one row of posts is placed parallel to the stream channel, and planks are nailed on the side away from the water as shown in Figure IV-4. Sandbags or earth fill must be placed behind the wall. A polyethylene sheet may be used to reduce seepage. Post and boards must be available at the site as must be the required equipment and manpower to drive the posts or dig postholes and to move large quantities of soil or sand.

The use of these emergency retaining wall structures will not generally create a watertight barrier. Therefore, sump pumps should be available to remove leakage and stormwater behind the wall. Pumps with sufficient capacity for this purpose should be readily available and in good repair at all times. Enough fuel to operate the pumps for the duration of the flood should be stored at the site. Electric pumps should not be used because electrical service may be interrupted when flooding occurs.

3. STOP LOG BARRIERS. A stop log barrier is basically a temporary wall that is constructed by stacking small beams or planks on top of each other in such a manner as to prevent the passage of water through them. These logs or planks may be dropped into slots in concrete walls (Figure IV-5) or into freestanding metal channels.

Stop logs are normally made from treated lumber that is at least two inches thick (for instance, 2" x 12" planks). Tongue-and-groove lumber may be used to provide a better fit between adjacent planks. Any type of material may be used to fabricate the logs provided that: (1) it can be easily transported and installed; (2) the logs fit together to form a watertight seal; and, (3) the resulting plank wall and supporting framework are strong enough to withstand flood-induced loading.

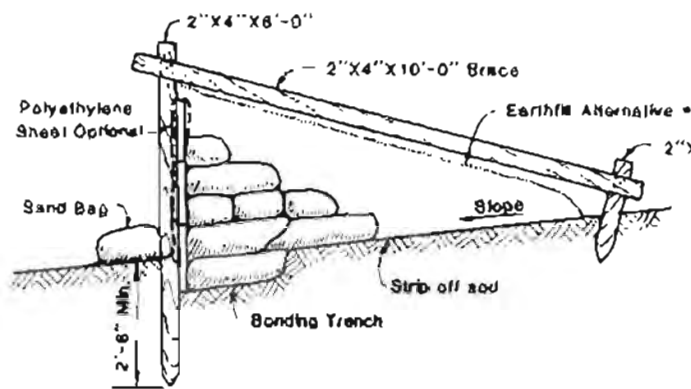

* Earth III may be substituted for bags in times of emergency.

SECTION

BILL OF MATERIAL FOR 100 LINEAR FEET OF WALL	
LUMBER	
26 pieces	1" X 12" X 12'
17 pieces	2" X 4" X 10'
17 pieces	2" X 4" X 6'
17 pieces	2" X 4" X 2'
*(Sharpened)	
NAILS	
1 lb.	8d nails
2 lbs.	16d nails
SANDBAGS	
1100 bags	

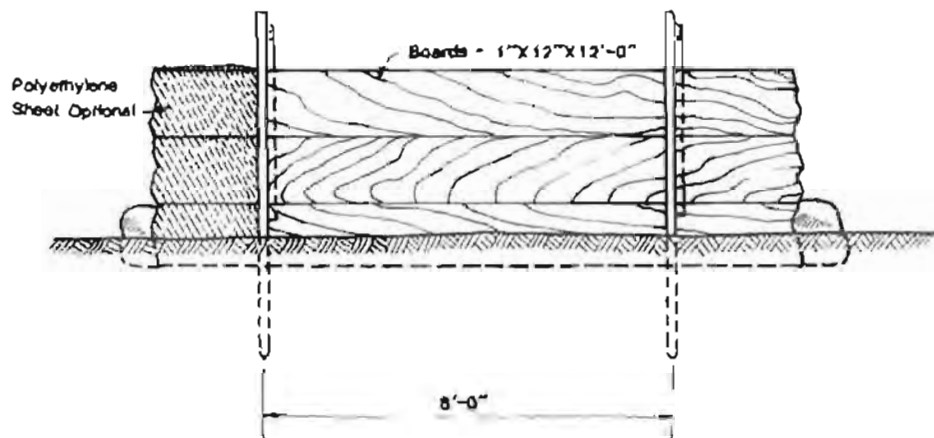

RIVERSIDE ELEVATION

Figure IV-4. Earth and Timber Retaining Wall

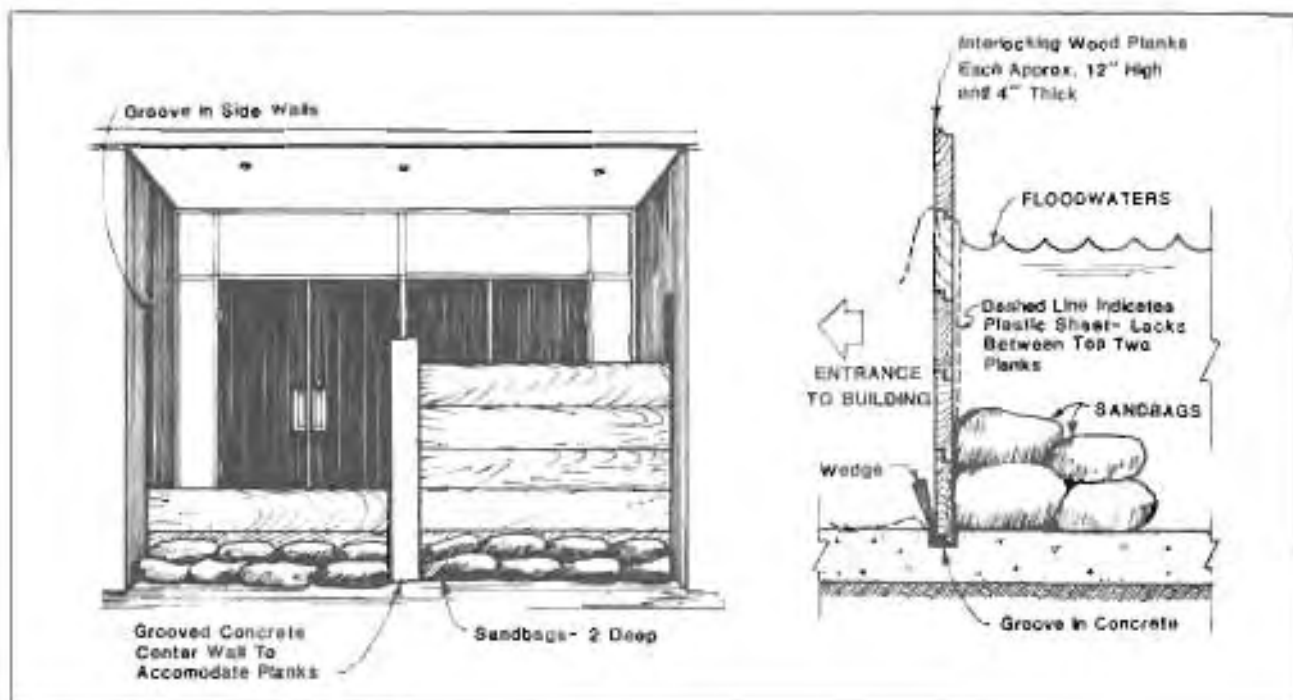

Figure IV-5. Typical Stop Log Barrier

Numerous methods may be used in conjunction with this type of barrier to reduce leakage. For example, polyethylene plastic sheets may be used as illustrated in Figure IV-5. The plastic is placed beneath the first plank and is held at the top by the top plank. For relatively heavy logs, the weight of the barrier may provide a suitable seal if a rubber gasket is placed under the bottom log or plank. It is recommended that a double layer of sandbags be placed at the base of the wall to help reduce seepage. As floodwaters rise, the resulting hydrostatic pressure will provide a reasonably watertight seal at the end of each log if the receiving slot is designed to include an appropriate sealing gasket. Swelling of the planks will tighten the seal. Because this type of flood barrier cannot generally provide a completely watertight seal, a permanent or portable pump should be available to discharge any leakage. Stop log barriers should be tested immediately when constructed to ensure that they are capable of providing an acceptable level of protection. General testing procedures are similar to those discussed in Chapter III for temporary flood shields.

C. FLOODPROOFING UTILITIES

Most of this manual is devoted to techniques that can be used to protect non-residential structures from flood damage. This section provides information concerning floodproofing of utilities that service the structure.

Elevation is the most effective way to prevent flood damage to exterior utilities. All incoming electrical power lines, transformers, and panels should be located at least one foot above the Design Flood elevation. Fuel tanks should also be elevated above the Design Flood level and be anchored (recommended safety factor of 1.5) to prevent flotation and associated damage. In addition, all fuel lines exposed to flooding should be equipped with automatic shut-off valves in case lines are broken.

Exhaust fans and louver outlets below the Design Flood level should be protected by flood shields (Figure IV-6) or enclosures or relocated above flood levels. At many non-residential facilities, utilities are located in a separate room or building adjacent to or near the main building. This utility room may be elevated, or constructed or modified to be watertight. Where flooding of a basement or utility room may occur (or is required for the safety of the structure), utility units may be protected and fuel tanks anchored.

Because sewer lines in most areas are highly susceptible to infiltration, they often become saturated during flooding events. In such cases floodwater may enter a facility through the sewer system and create internal flooding that is near or equal to exterior flood levels. To prevent this, backflow prevention valves should be placed on the building's sewer lines.

There are several alternatives for locating backflow devices. A main valve may be located where the sewer is strong enough to resist the flood-induced pressures and where all possible reverse flows can be stopped (Locations 'A' and 'B' in Figure IV-7). The valve should be selected to accommodate grit and other materials that could lodge in it. For pipe of

sufficient strength, separate valves may be installed on all basement fixtures and floor drains (Figure IV-7). Inflatable rubber plugs or mechanically expandable rubber plugs can also be used. Low pressure valves (20 pounds per square inch or less) may be installed in drain lines of fixtures that are below Design Flood levels. Sump pumps to handle any leakage should be provided. Alternative valve systems are shown in Figure IV-9.

Figure IV-8 presents another alternative for controlling sewer backup. All drainage and scuppers is directed to a sump pump. The pump lifts drainage to an elevation above the Design Flood. By thus eliminating all gravity sewer drains, the problem of flooding backflow is eliminated.

Water distribution lines are usually not contaminated when flooding occurs unless the water plant itself is flooded. However, for those sites where wells are used for potable water, precautions should be taken to prevent contamination. The well should be equipped with a watertight casing that extends from one foot above the ground surface to at least 25 feet below the ground surface. Backflow prevention valves should be placed on the primary water service line at the well, and where it enters the building to prevent backflow of floodwater in case of a line break.

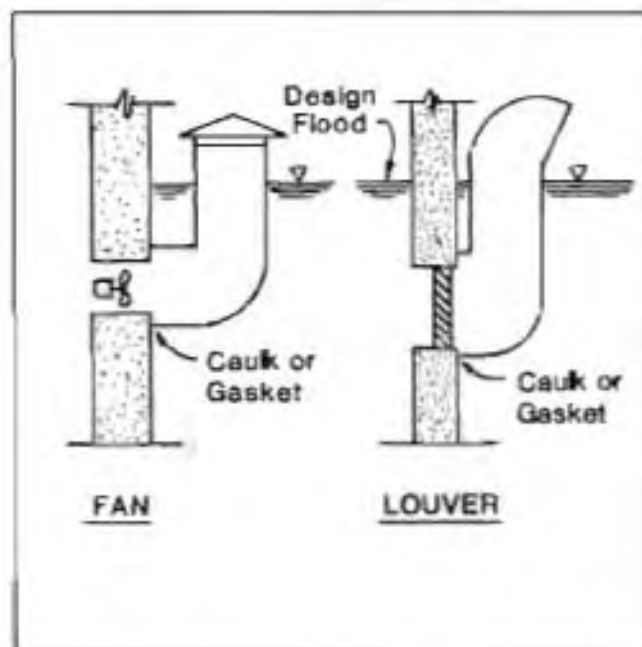

Figure IV-6. Floodshield for Exterior Openings

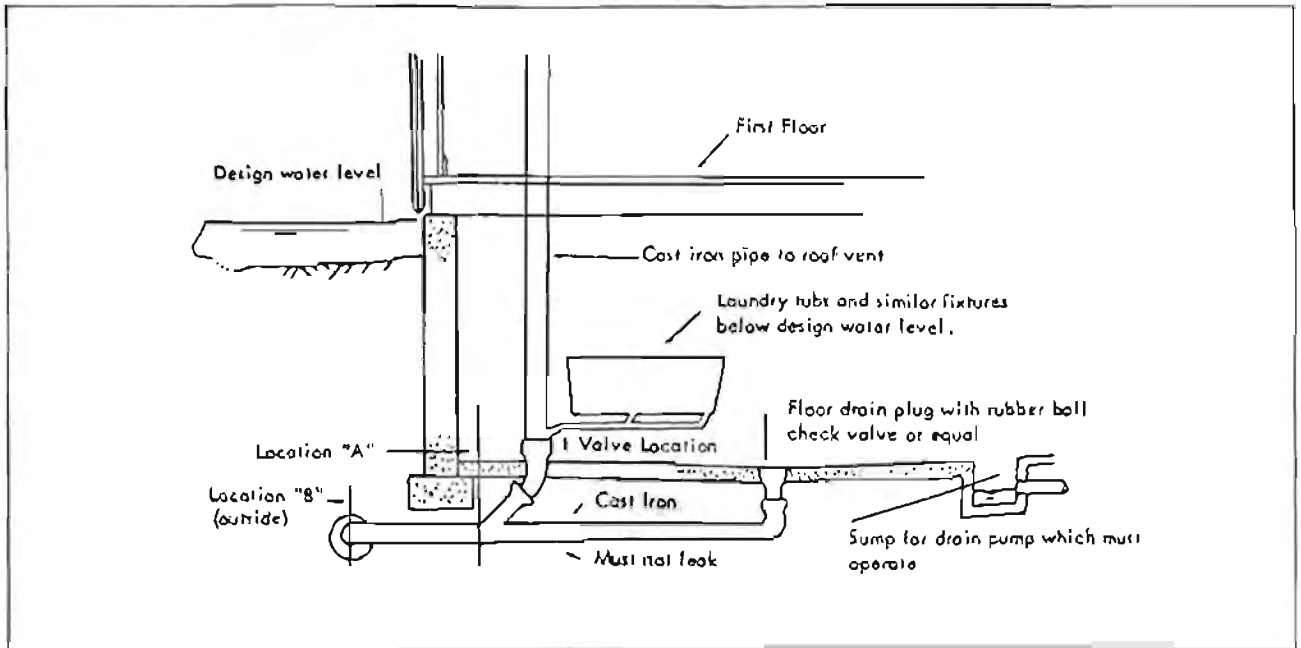

Figure IV-7. Alternative Locations for Cutoff Valves on Sewer Lines

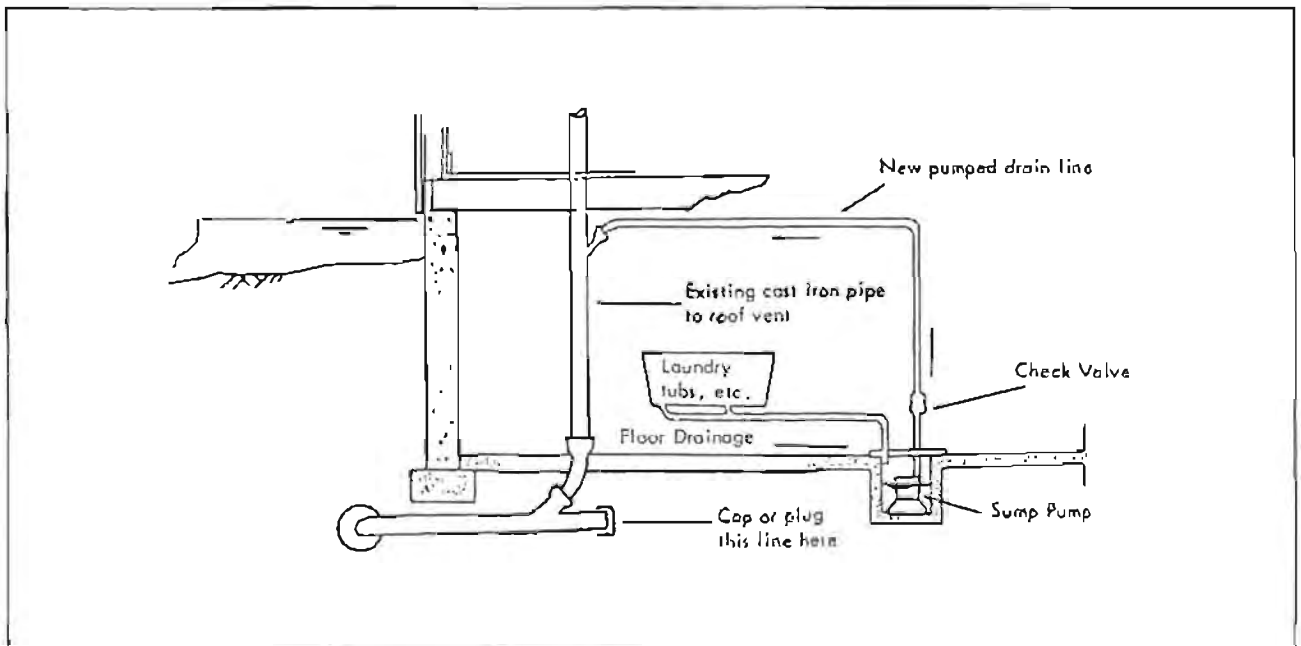
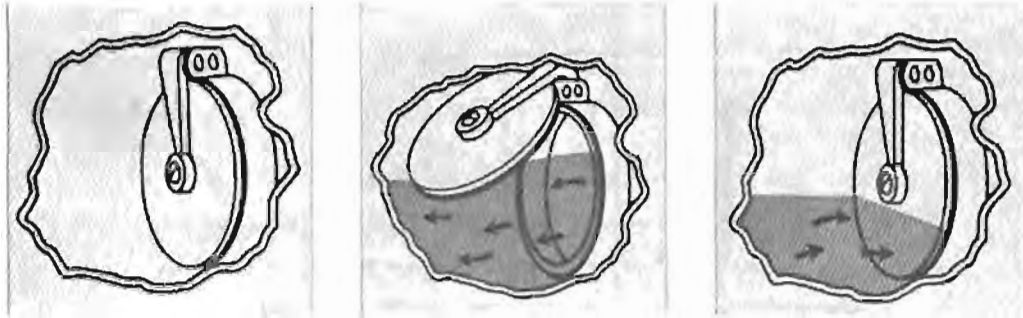

Figure IV-8. Elimination of Gravity Flow Basement Drains



Normal Position
Closed with No Flow

Flow Position
Variable Depending on
Discharge Flow

Backflow Position
Instant Closing with Backflow

OPERATION OF SWING-CHECK BACKWATER VALVE

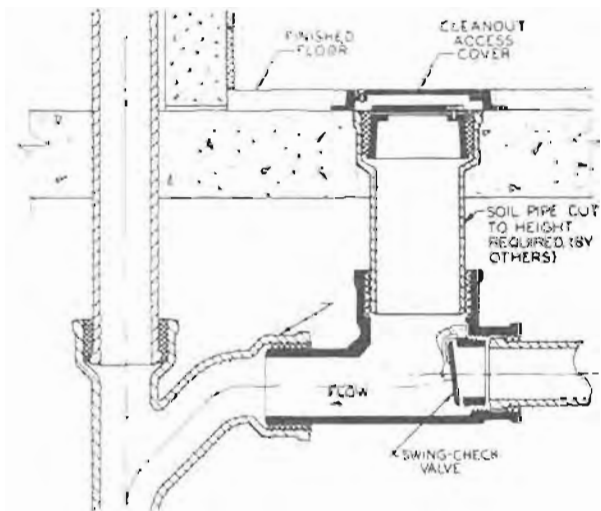

TYPICAL INSTALLATION OF SWING-CHECK VALVE



SHEAR-GATE VALVE

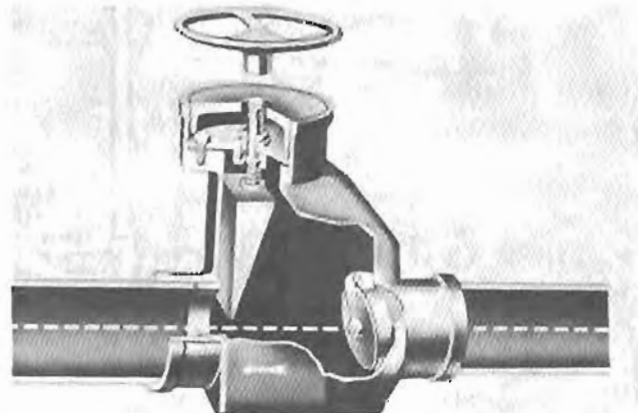

**TYPICAL INSTALLATION OF SHEAR-GATE
AND SWING-CHECK VALVE**

Figure IV-9. Sewage Backflow Prevention
Devices

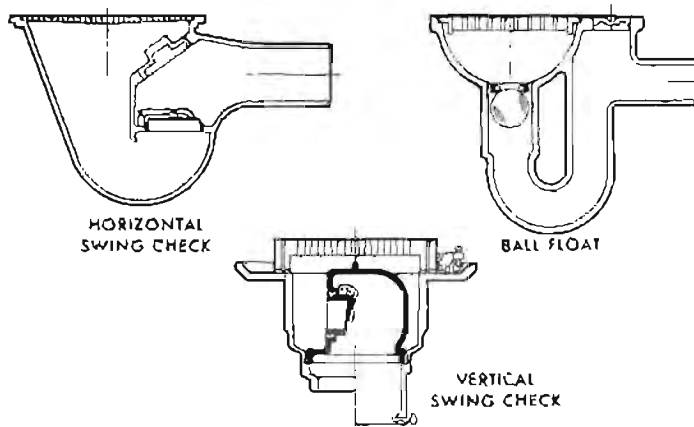

VARIOUS EXAMPLES OF BACKWATER VALVES

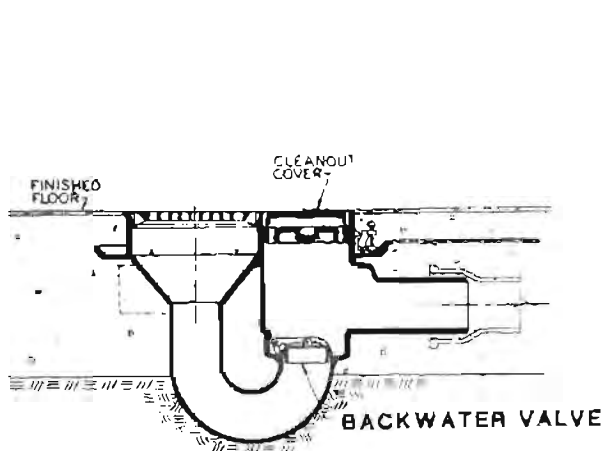

FLOOR DRAIN WITH INTEGRAL BACKWATER VALVE

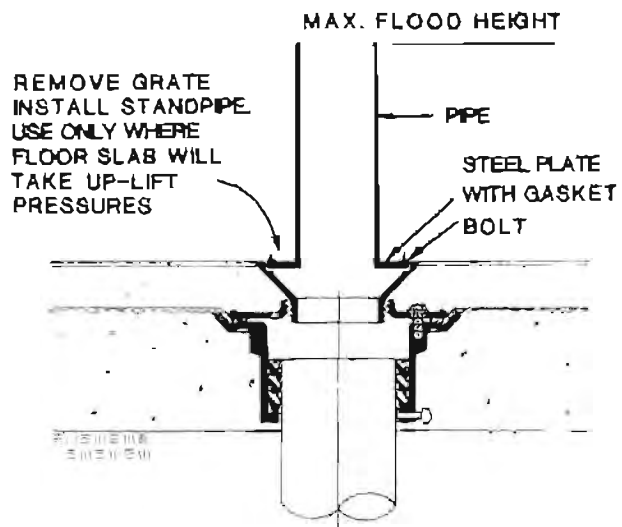

EXISTING BASEMENT DRAIN FLOOD-PROOFING

Figure IV-9. Sewage Backflow Prevention Devices (continued).

Heating or air conditioning units, or similar facilities that are located outside the structure, must also be floodproofed. Elevating the equipment is preferred, but if this is not feasible, a watertight closure system should be provided (see Figure IV-10). It is especially desirable to prevent air conditioning units from being damaged, because they can be used as dehumidifiers after the flood.

To complete the utility system floodproofing process, all openings below the Design Flood elevation where pipes, conduits, vents, or other fixtures pass through a floor or exterior wall must be sealed to prevent leakage. Penetrations can be pressure sealed in several ways: gel-like expansive sealants, elastomeric seals, molded sleeves, and neoprene seals. Figure IV-11 illustrates the use of a waterproof sleeve.

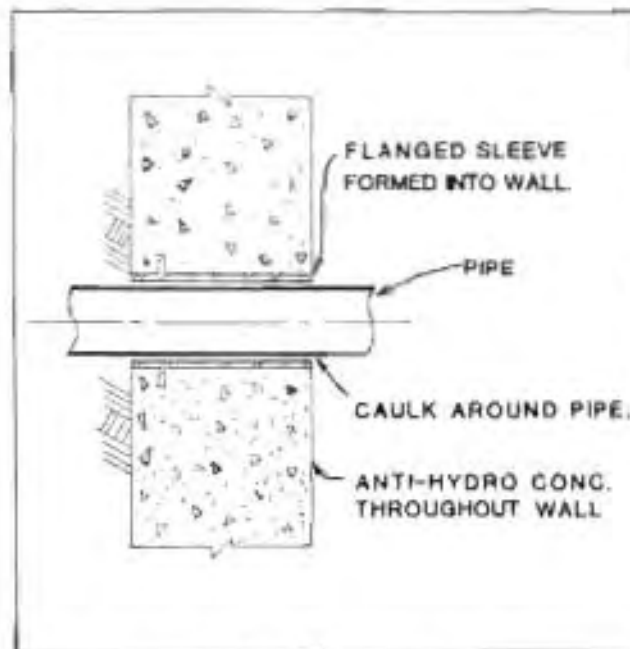

Figure IV-11. Waterproof Sleeve for Pipe Penetrations

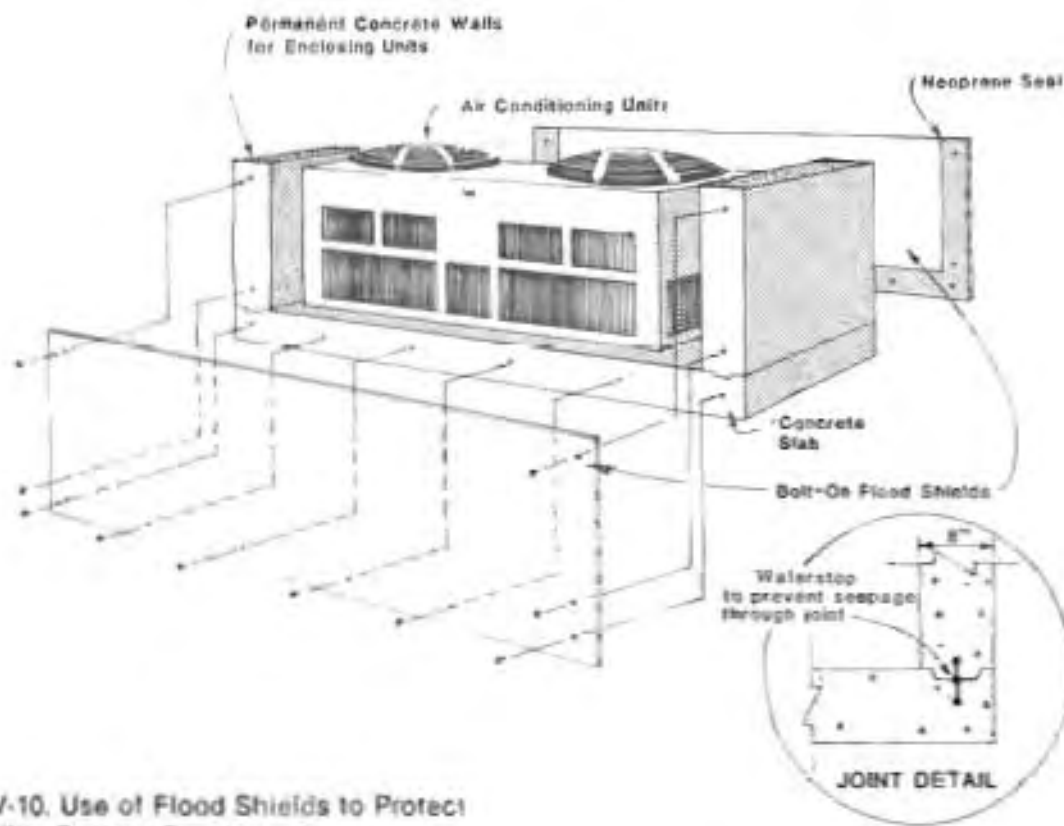

Figure IV-10. Use of Flood Shields to Protect Major Utility System Components

D. WET FLOODPROOFING TECHNIQUES

A properly designed and implemented floodproofing plan can virtually eliminate flood damage. A floodproofing plan may fail, however, for several reasons. Flood conditions may be more severe than planned for in the Design Flood. A flood may exceed the design level of floodproofing due to storm events greater than those associated with the Design Flood, or flood elevations may be raised above the Design Flood level by a stream or river that becomes blocked by debris or by man-made obstructions. Accidental damage to the structure or a critical component of the floodproofing system may occur. For example, floating debris may impose sufficient impact loads to bend a flood shield or crack a wall and allow water to enter the facility.

Failure may also occur if the plan is improperly implemented (i.e., if all floodproofing components are not properly installed). This could result from human error in evaluating flood conditions, from equipment failure or from lack of preparedness planning and training.

Finally, failure may occur due to a faulty floodproofing design. Examples of improper design decisions include the use of incorrect depth and velocity data, incorrect analysis of stability or strength, or failure to recognize and protect all openings below the flood level. As stated in Chapter 1, the scope of this manual is specifically limited to 'dry' floodproofing techniques. However, given the possibility of failure, some consideration must be given to damage reduction measures that can be used when water enters a structure. These measures are generally referred to as 'wet floodproofing'. In some instances, wet floodproofing may offer the only feasible alternative for dealing with flooding at existing structures. Wet floodproofing techniques are briefly discussed below. Additional wet floodproofing techniques are described in other sources (see Appendix A).

Utilities must be protected from interior flooding. All interior electrical lines and panels should be elevated above the Design Flood level. Electrical systems should be 'zoned', allowing selective cutoff.

Switches must be located in an area that will be accessible during a flood. Gas lines should be equipped with automatic shut-off valves to prevent leakage and resulting fire or explosion in case a line should break. The gas lines should be installed to allow positive drainage of water that may enter the system to an appropriate number of drainage plugs. Positive drainage to appropriate release points should also be provided for any ductwork that is below the Design Flood level. All heating, ventilating, and air conditioning equipment should be elevated above the Design Flood elevation; or, critical equipment may be enclosed in a watertight core as discussed in Chapter III

In addition to actions that can be taken to protect the interior utilities, there are several measures that can be used to reduce damages throughout the facility. These techniques include the use of waterproof paints, finishes, flooring materials, and cabinetry. All critical records, files, documents, and computer facilities should be sited at a location that is well above the Design Flood elevation. To remove water from the building as quickly as possible after a flood, all floors should have a positive slope to a sump that can be used to pump water out of the structure as floodwaters begin to recede. However, to avoid damage to the structure, interior and exterior water levels should be kept approximately equal at all times.

A small percentage of equipment or stock may constitute a major portion of the flood damage that could occur. In this case, evacuation of this critical property would represent an important feature in reducing the risk of flood damage. If heavy equipment is to be removed, overhead hoists may be required to elevate the equipment above the floodwaters or to remove the equipment from the structure. For sites where smaller equipment or stock is to be removed, or where a hoist cannot be provided, aisles should be designed to accommodate fork lifts or similar transport equipment. The material to be evacuated should be on pallets or should be equipped with lifting eyes or bars. To facilitate the removal of manufacturing equipment, all electric lines, oil lines, etc. should be provided with quick disconnects. A safe, reliable form of transportation

must be provided between the floodproofed structure and a storage location well above the Design Flood elevation. Comprehensive guidance concerning wet floodproofing can be obtained from the Federal Emergency Management Agency's Technical Standards Bulletin 85-1, *Wet Floodproofing*.

E. COMBINATION OF FLOODPROOFING TECHNIQUES

A single floodproofing technique may be of limited effectiveness. However, when the techniques described in this chapter and Chapters III are combined to meet the requirements of a particular structure, they may lead to significant hazard reduction. Figure IV-12 shows how a variety of techniques may be applied to a single industrial structure.

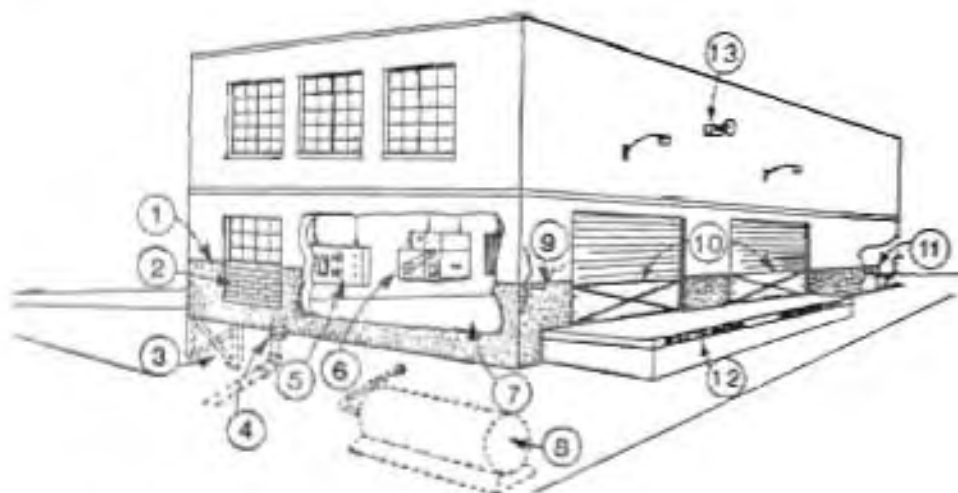

1. Waterproof coating to reduce seepage
2. Permanent closure of opening with masonry
3. Underpinning of structure to resist hydrostatic pressure
4. Valve on sewer line to prevent backflow
5. Instrument panel raised above expected flood level
6. Major equipment installed with quick-disconnects and elevated above flood level with overhead hoist
7. Floor has been reinforced to withstand uplift pressure
8. Underground storage tank properly anchored
9. Cracks sealed with hydraulic cement
10. Steel bulkheads for doorways
11. Sump pump and drain to eject seepage
12. Rescheduling has emptied the loading dock
13. Audible alarm installed as part of area-wide flood warning system

Figure IV-12. Combination of Floodproofing Techniques as Applied to Typical Industrial Structure

Adopted From: Introduction to Floodproofing by John Sheaffer, The Center for Urban Studies, 1967, University of Chicago

CHAPTER V



COSTS AND BENEFITS OF FLOODPROOFING METHODS

A. INTRODUCTION

The primary goal of floodproofing is to reduce flood damages and flood losses. This chapter provides information that can be used to estimate the cost of anticipated floodproofing and the associated dollar benefit of reduced flood damages.

The costs of floodproofing a structure may be evaluated in terms of *primary* and *secondary* costs (Table V-1). *Primary costs* include the costs of the basic floodproofing elements: fill, columns, floodwalls, levees, and flood shields or closures. *Secondary costs* include the costs of auxiliary materials and activities that are required to assure that the primary floodproofing elements function properly. (Such as the cost for providing access to buildings on fill, or interior drainage for areas enclosed by levees or floodwalls). This chapter provides representative costs for each of the primary floodproofing elements and for some of the more common secondary elements.

Unit costs reported in this chapter have been based on an analysis of floodproofing literature, manufacturer's quotations, and information collected from the owners and builders of floodproofed structures (See Case Studies in Chapter VI). All costs are based upon September, 1985 price levels using the *Engineering News Record* cost index (20 cities average).

Cost estimates were developed using many sources. Most of the reported costs for a particular element were clustered in a narrow range around the average. Therefore, the average costs presented in this chapter should provide reasonable estimates for the evaluation of alternative floodproofing plans.

**TABLE V-1
PRIMARY AND SECONDARY
FLOODPROOFING ELEMENTS**

Primary Elements	Secondary Elements
Elevation (fill, piles, posts, piers, walls)	Lost space Extending access and utilities Insulating/finishing lower surface of elevated floor Erosion protection
Flood Shields	Waterproofing walls and floors Subfloor drainage Backflow prevention Flood warning system Manpower training/availability Testing
Floodwalls/Levees	Backflow prevention Interior drainage system and pump Lost space Erosion protection Access



B. PRIMARY COSTS

This section discusses primary costs associated with elevation, closures and flood shields, floodwalls, and levees. The primary costs include the costs of construction materials and associated placement or installation. Additional items included in the primary cost are described in the following subsections.

1. ELEVATION OF NEW STRUCTURES ON FILL. The use of fill for elevating new structures is a floodproofing technique that is widely practiced throughout the United States. To compute the cost of a fill operation, it is necessary to develop site-specific estimates of costs associated with:

- Clearing and grubbing the proposed fill area of vegetation.
- Stripping and removing any topsoil that is not capable of providing required stability.
- Obtaining, hauling, placing and compacting the fill.

Previous studies indicate that the costs for these activities can vary significantly as a result of regional and site specific characteristics. In general, costs of elevated fill construction in the eastern U.S. are higher than in the West. Cost of elevated fills are also higher in large metropolitan areas, and in many coastal and mountainous regions. Although specific costs representing any given location cannot be addressed, it is possible to present average costs which may be used to develop preliminary estimates.

For small and moderate size fills (up to 20,000 cubic yards) an average cost of \$7 per cubic yard of compacted fill was found to be representative. This includes all costs associated with developing the final site - clearing and grubbing, topsoil removal, and obtaining, hauling, placing and compacting the fill material. This cost figure should be adjusted if fill must be hauled for more than several miles or if unusual site conditions occur, such as extremely dense forest cover or deep unstable topsoil.

It may be useful for planning purposes to have the cost of placing fill on a cost-per-square-foot basis. Figure V-1 has been included to provide this information. Figure V-1 illustrates the fact that when the usable fill area is relatively small (1,500 square feet) the cost per square foot increases very rapidly with increasing depth. For large areas (150,000 square feet or more), the cost per square foot of usable space increases approximately in direct proportion to the depth of fill.



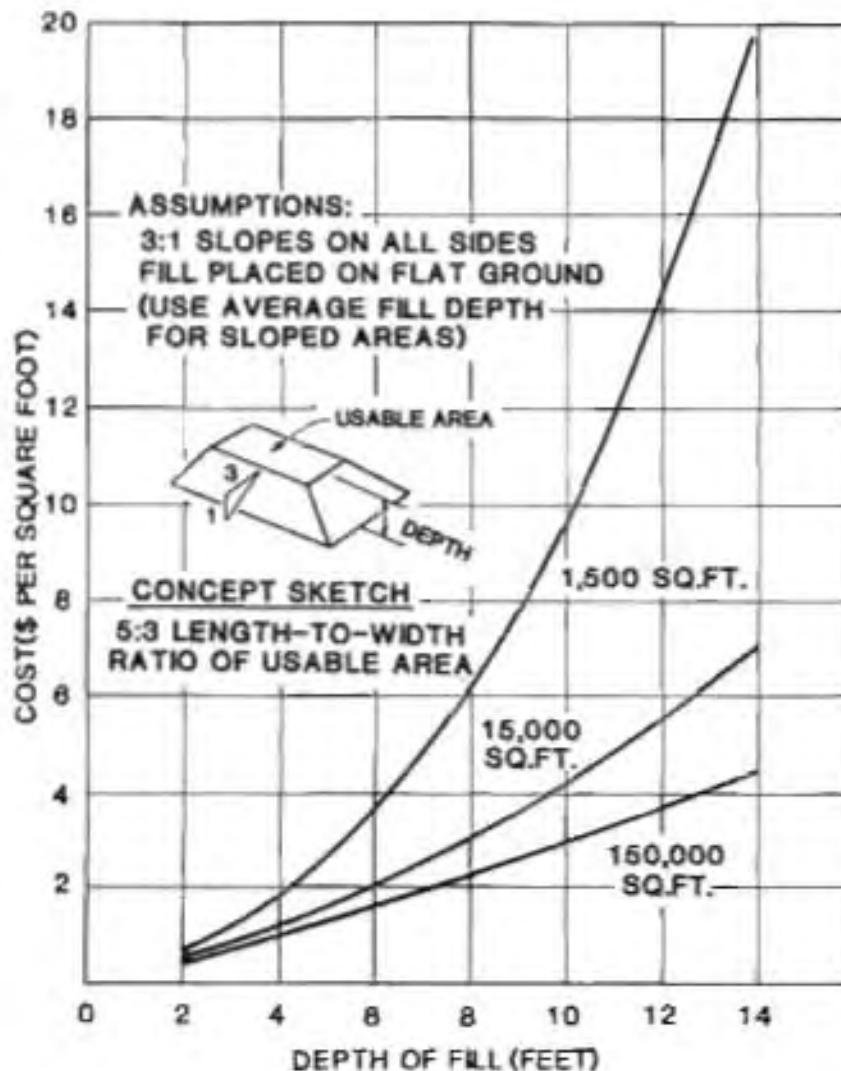

Figure V-1. Cost of Elevating on Fill

2. ELEVATION OF NEW STRUCTURES ON POSTS, PILES, PIERS OR WALLS. The cost of concrete column sections is considerably higher than the cost of piles or posts. However, since concrete columns can support significantly greater loads than piles or posts, the costs for each of these methods tend to converge. The height of elevation (between 4 and 12 feet) has little influence on the cost of the complete foundation system. Therefore, an average of \$6.40 per square foot of single floor space was found to be representative as a preliminary cost estimate for any of these methods. This average includes all costs associated with the construction of the elevated foundation and supporting members.

Several of the sources reviewed in developing these cost data reported that there was no net additional cost for their structure due to the use of piles, posts, piers or walls for elevation. In these cases, the value of the open space beneath the structure (such as parking space in high land cost areas) was equal to or greater than the cost of elevation. This benefit of elevation on columns may often outweigh the primary cost advantage of elevation on fill.

3. ELEVATION OF EXISTING STRUCTURES ON POSTS, PILES, PIERS OR WALLS. It is technically feasible and cost-effective to elevate certain existing structures for protection against flood damages. As discussed in previous chapters, this approach has traditionally been limited to small frame structures that have a unified floor system.

The cost of elevating an existing structure includes two major components: (1) raising the structure, and (2) construction of a support system. The average cost for constructing a support system is the same as that for new structures, \$6.40 per square foot of single floor space. The cost of raising the structure is presented below.

Generally, elevation of existing structures is most suitable for small to medium size wood-frame structures that are built on a crawl space or basement foundation. The average cost for raising this type of structure is \$4.10 per square foot of floor area.

Brick veneer and masonry structures are the next most frequently raised. The average cost for raising this type of structure, \$8.10 per square foot, is higher than that for a wood-frame structure primarily because of the greater weight and the care that must be taken to prevent excessive cracking.

The costs reported above are average costs. Factors that could cause variation from the average are accessibility (amount of clear space around and under the structure, proximity to trees or utility poles), and the existence of fireplaces and chimneys. The height a structure is raised has little influence on the total cost of raising.

4. FLOOD SHIELDS AND CLOSURES. The primary cost incurred when a structure is modified or designed to be watertight is the cost of the flood shield assemblies and closures.

Permanent closures are applicable for openings in existing structures that are not needed for normal or emergency access. These openings may be sealed by filling the opening with concrete block, reinforced concrete, brick, or some other material. The cost of this technique must include provisions to structurally

integrate the closure with the existing wall to ensure that the closure will withstand flood-induced pressures. Due to the variation in existing types of structures and in the methods used to close an opening, there is considerable variation in the cost of this floodproofing technique. However, a cost of \$45 per square foot of closure area should provide a reasonable preliminary estimate.

For new structures, or for existing structures that have openings that cannot be permanently closed, removable flood shields may be used for protection. Most flood shields are constructed of metal (primarily steel and aluminum). Plywood has also been used for flood shields in cases where Design Flood depths are relatively low. Flood shields also vary according to their method of application. Some are free standing and must be transported to and from the point of application and attached to a suitable supporting frame. Larger shields are often mounted on hinges or tracks so that they can be stored at the point of application and be easily and quickly installed.

Many steel free-standing flood shields have been fabricated at local machine shops or metal-working shops. The average cost of this type of shield has been calculated at \$60 per square foot of shield. This includes the cost of manufacturing and installing the flood shield frame. Factory-produced shields are considerably more expensive. However, factory-produced shields have been fully tested and the reliability of these shields is very high. The average cost of various sizes of factory-produced shields can be derived from Figure V-2.

The costs of plywood floodshields are less variable and much lower than those discussed above. The average unit cost for plywood shields (including installation) is approximately \$16 per square foot of flood shield.

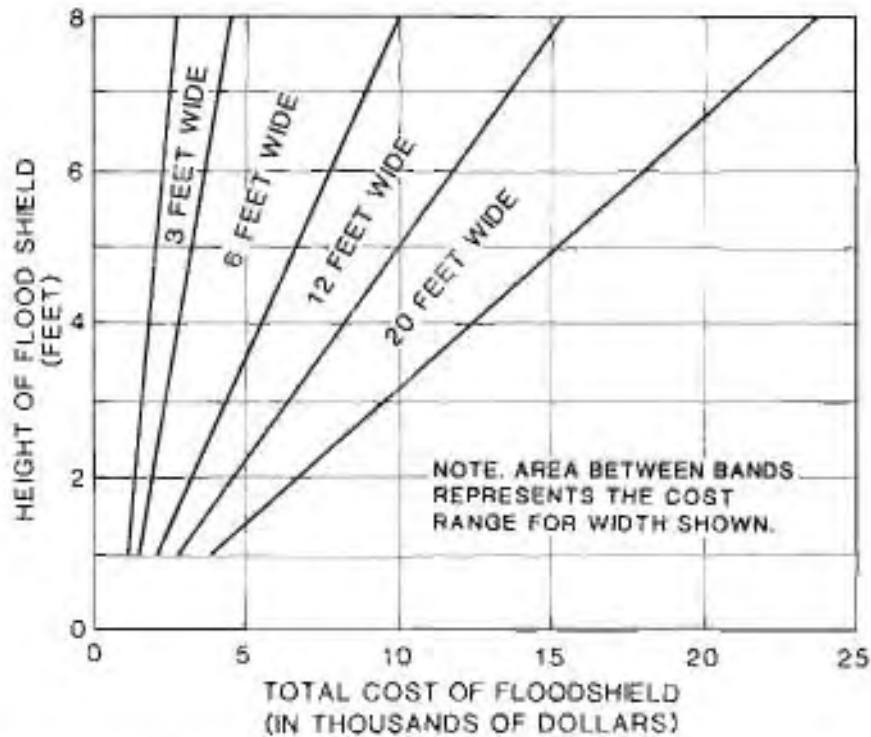

Figure V-2. Costs of Factory Produced Flood Shields Versus Shield Heights and Width

5. FLOODWALLS AND LEVEES. The costs of constructing floodwalls and levees are highly variable because of the wide range of site-specific physical and usage factors. Table V-2 presents average costs for three heights of floodwalls and levees. Although these costs may be used to develop preliminary estimates, specific site conditions could result in costs that vary considerably from those shown in Table V-2.

The levee costs shown in Table V-2 are for non-zoned structures (i.e., unsegregated fill material.) Levees with complex impervious cores to reduce seepage may cost up to four times more than non-zoned levees.

TABLE V-2
AVERAGE COST OF FLOODWALLS
AND NON-ZONED LEVEES

Item	Height (feet)	Unit Cost (\$/foot length)
Floodwall	3	110
Floodwall	5	165
Floodwall	10	410
Levee	3	13
Levee	5	30
Levee	10	85

C. SECONDARY COSTS

Secondary floodproofing costs were defined as the costs of items that are necessary to ensure the proper functioning of the primary floodproofing measure. Secondary costs that are often incurred are summarized in Table V-5 and are discussed below. Estimated average unit costs are provided where applicable.

1. LOST SPACE. Whenever an earth fill or a levee embankment is constructed, productive space is lost because of the outlopes required to maintain stability. The dollar cost associated with this lost space varies so widely with land costs and other factors that representative estimates cannot be given. Site specific costs must be derived from the geometry of the outslope fill and the unit value of the lost space.

Figure V-3, based on the assumptions of Figure V-1, shows lost space as a function of fill height and usable area. Lost space is considered to be only the area covered by the outslope.

2. EXTENDING ACCESS AND UTILITIES. Secondary costs of elevating a structure on posts, piles, piers, or walls include the costs required to provide access from the original ground level to the elevated level and to extend all utilities to the elevated structure. Experience has shown that this cost is approximately \$3.80 per square foot of single floor space. This estimate is based on the assumption that the structure is elevated 4 to 10 feet.

3. INSULATING AND FINISHING ELEVATED FLOORS. Elevation on an open support system exposes the area below the lowest floor to the weather and to public view. It may be

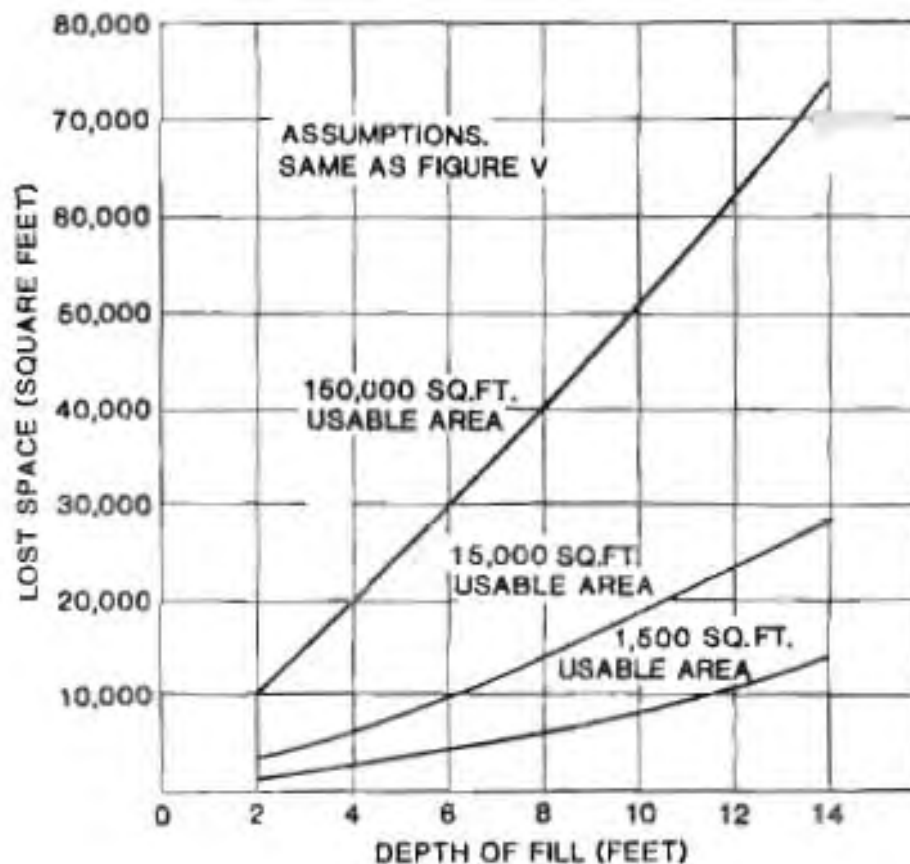

Figure V-3. Lost Space - Elevation on Fill

necessary or desirable to insulate the bottom surface and/or provide a finish or covering that complements the architectural style of the building. Estimates of typical costs for this item cannot be presented due to the many site specific variables.

4. EROSION PROTECTION. High velocity floodwater can result in severe erosion of an earth fill or levee embankment. The most commonly used form of erosion protection for these embankments is rock riprap. The cost of riprap for this purpose is \$22 per cubic yard installed. Information has been provided in Chapter III that describes when riprap should be used and what volume will be required. For embankments with 3:1 side slopes (3 horizontal to 1 vertical), and height H, a typical cost of $\$2.06 \times H$ per linear foot of embankment may be used. For example, riprap protection for 100 feet of 5 foot embankment would cost about \$1,025 ($\$2.06 \times 5 \times 100$).

5. WATERPROOFING WALLS. The walls of structures that are protected with floodshields or closures must be substantially impermeable to the passage of water. For new construction, sufficient waterproofing provisions can often be included in the design of the building at no significant cost. For existing structures, sound masonry, brick, or concrete walls may be waterproofed by installing an impermeable membrane or by applying a number of products which can be painted, sprayed, or troweled onto the wall surface.

The costs of these waterproofing methods are quite comparable, with an average cost of approximately \$1.85 per square foot of wall surface.

6. WATERPROOFING FLOORS. If the floor of a structure that has been floodproofed with shields and closures is strong enough to withstand the uplift forces that could be exerted against it, waterproofing techniques can be used to seal cracks and construction joints to prevent the entry of floodwater. The cost of sealing would be comparable to costs for sealing walls as described above. However, if the slab does not have sufficient strength to resist full hydrostatic pressure, a subsurface drainage system will probably be required to prevent floor failure.



A typical sub-floor drainage system is illustrated in Chapter III. The approximate costs per square foot for this type of system are illustrated in Figure V-4. The square footage costs shown in Figure V-4 are total system costs, including drainage pipe, gravel, sump area, and pumps. Installation of a sub-floor drainage system is usually not practical for an existing structure because of the high cost of removing the floor. In this case, a drainage system may be constructed around the perimeter of the structure at a level below the floor slab elevation. The installation cost of a perimeter drainage system can be estimated at \$26 per linear foot.

7. BACKFLOW PREVENTION. Whenever flooding occurs above the lowest floor level, floodwater may enter the sewers and back up into the building. All floodproofed buildings should have a protection device on the service line to prevent backflow. The average price for placing a gate or flap valve for backflow prevention on a new sewer line is \$720 installed. For an existing sewer, there are additional costs depending upon whether a suitable connection point can be obtained by excavating soil or whether concrete must be removed.

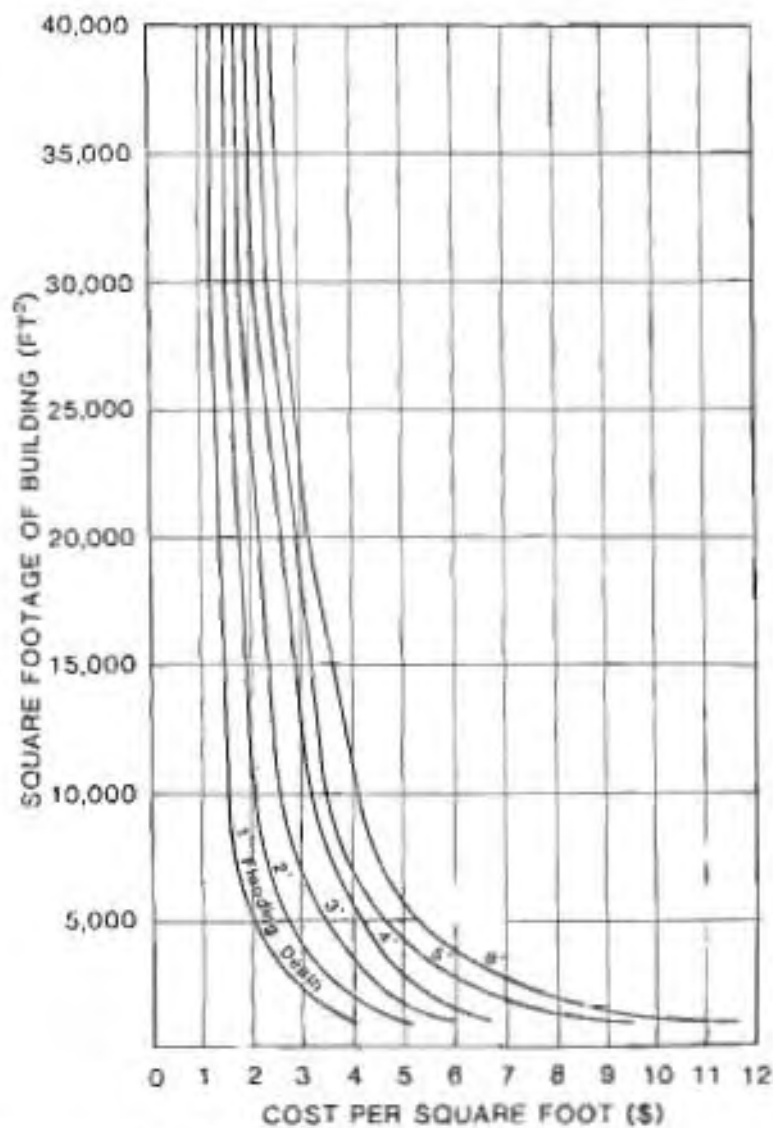

Figure V-4. Approximate Cost of Sub-floor Drainage System per Square Foot of Basement Floor Space

8. FLOOD WARNING AND PREPAREDNESS.

An adequate flood warning system must be included in the cost of any floodproofing plan that requires adjustments to the structure prior to the flood (i.e., contingent and emergency measures). In addition, a flood preparedness plan and training program is required to ensure that floodproofing elements are installed properly and efficiently.

Because an effective flood warning system must be developed in response to specific flooding source and structure characteristics, no representative cost can be given here. At many locations on major streams, the National Weather Service provides flood warnings. In addition, the cost of emergency preparedness depends on the non-residential structure's existing operations. Many facilities already have an extensive emergency preparedness program for fire or other hazards.

In this case, the cost of developing a preparedness plan for flooding may be minimal. Other facilities may incur a considerable annual cost to develop and maintain a preparedness plan and associated training program.

9. INTERIOR DRAINAGE PROVISIONS. As discussed in Chapter III, an interior drainage system to remove seepage and storm water may be required for floodwall and levee floodproofing systems. A significant cost of the interior drainage system will be the cost of the pump required to move water from the dry to the wet side of the wall or levee. Considerations for selecting an appropriate pump size were addressed in Chapter III. The approximate cost of various sizes of pumps is shown below:

Pump Rate Gallons Per Minute	Approximate Cost (\$)
10	400
60	530
120	960
160	1,600
220	2,000

In addition to the cost of the pump, it may be necessary to re-grade the area behind the wall or levee to direct runoff and seepage to a sump area.

Temporary detention areas may be created for sites that receive an extensive amount of runoff. If detention areas are not feasible, a permanent pump-house may need to be constructed to collect the water and to house the relatively large pump that will be required. Because the costs of these support facilities are based on site specific topography and other characteristics, typical costs cannot be estimated.

10. TESTING OF FLOOD SHIELDS. If flood shields are installed on a structure, a representative sample should be tested to ensure that they work properly. One method of testing is to build a concrete block wall around the opening to be tested, install the shield, fill the enclosure with water, and maintain the test depth for at least 48 hours. The cost of this type of test will range from \$150 to \$400 per opening depending upon the size of the flood shield.

11. ACCESS THROUGH FLOODWALLS AND LEVEES. Floodwalls and levees may require openings or other forms of access to allow traffic to move through the enclosure. Access points are often protected with flood shields. For small openings the cost of the closure can be estimated using the unit price given for flood shields. For larger openings, a value from Figure V-2 may be used.

D. FUTURE COST ADJUSTMENTS

The primary and secondary costs provided above are based on September 1985 estimates. These estimates can be adjusted using the *Engineering News-Record's* (ENR) construction cost index. The value of the ENR index on September 19, 1985 was 4,194. The following formula may be used to adjust estimates to current levels:

$$\frac{\text{Current ENR Cost Index}}{4,194} \times \frac{\text{Unit Cost Listed in this manual}}{=} \text{Current Unit Cost}$$

The ENR index can also be used to adjust costs to reflect regional differences. The unit costs included in this manual are based on the ENR '20 cities average.' Specific city index levels may be used in the above formula to correct the cost estimates for both time and location.

E. EXPECTED DAMAGE REDUCTION

The goal of flood protection is to reduce future flood damages. Some of these expected damages may be represented by dollar costs (that is, may be quantifiable), whereas other damages, such as loss of life, injury, or health hazards, may not be representable by dollar costs. A method for estimating quantifiable flood damage costs will be presented in this section.

Quantifiable damages that are normally expected to occur if a structure is not floodproofed include the costs to repair flood damages and business costs such as lost production and sales. The dollars expected to be saved by reducing flood damages should be viewed as the 'economic benefits' of floodproofing.

Two sets of information are required to estimate future flood damages to a facility: (1) frequency of flooding versus elevation of flooding at the site, and (2) the relationship of flood depth to flood damages. Figure V-5 and V-6 provide samples of how this information might be presented.

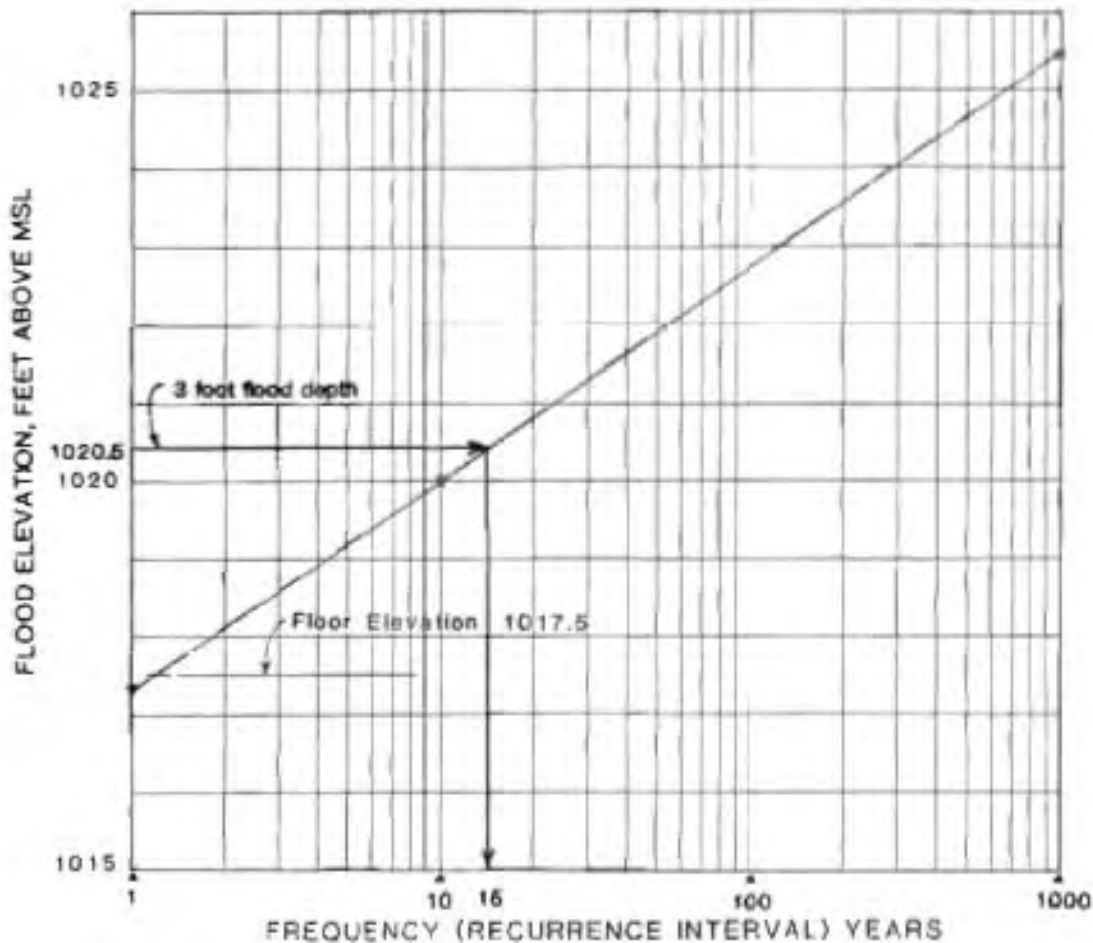

Figure V-5. Frequency - Elevation Curve for Example Site

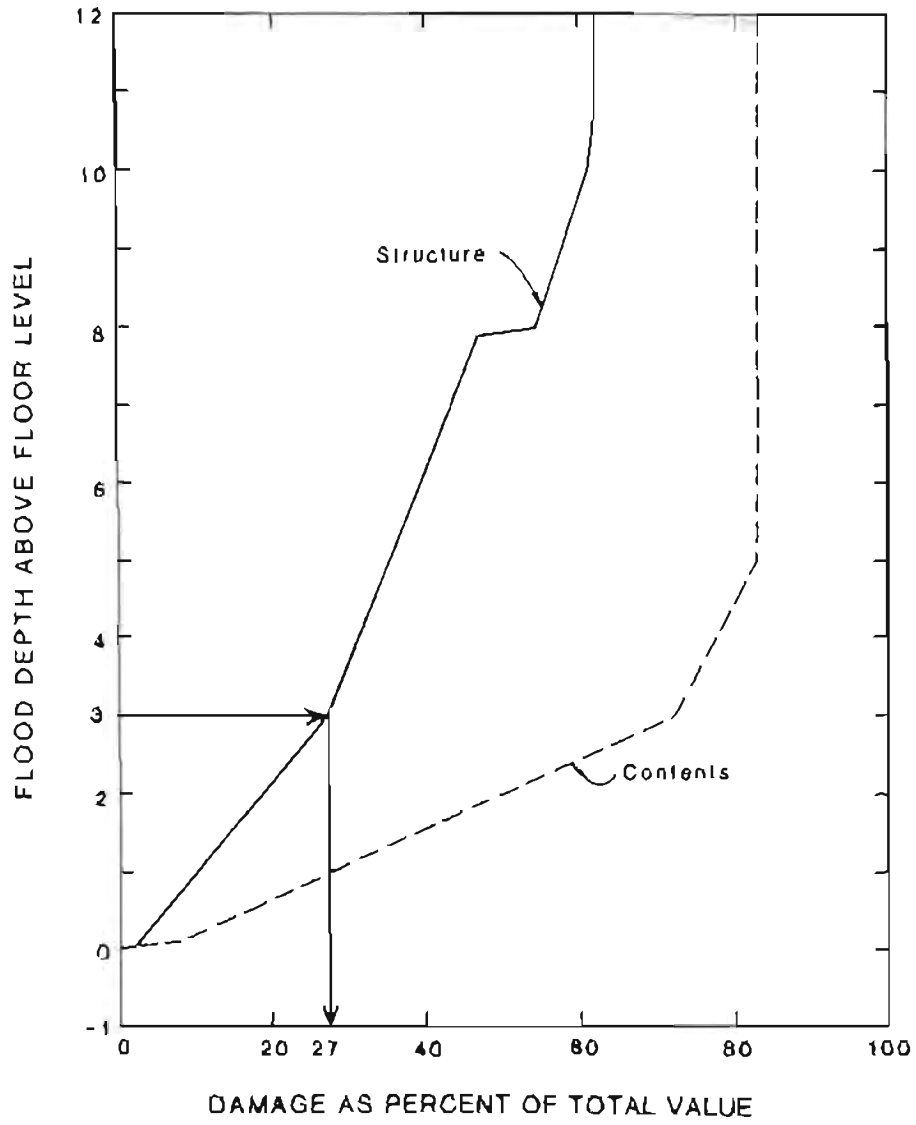

Figure V-8. Depth - Damage Relationship for Example Site

Flood elevation-frequency data may be obtainable from one of the sources listed in Appendix C. Flood Insurance Study Maps and Reports may be used to obtain flood depth and frequency at a structure using the methods shown in Appendix E. If flooding information is not available from any public agency, such data can be developed by a professional engineer. Generalized depth-damage information based on damages experienced by structures of similar size, construction, and use may be obtained from the Federal Emergency Management Agency, Corps of Engineers, or other agencies that have conducted flood damage reduction investigations.

Given the depth-frequency and depth-damage curves, the expected damage at the site can be computed by using a procedure similar to that shown in Table V-3. This method is used to compute the total expected annual flood damages, up to a given Design Flood level, that the unprotected facility would incur.

Using the method illustrated by Table V-3, expected damages from a range of flood depths may be calculated up to the Design Flood depth. In the example shown, the 100-year frequency flood was used as the Design Flood. Flood depths of 0.5, 1, 2, 3, 4, and 5.3 (the Design Flood depth) feet were used.

Assuming expected damages for floods up to two feet have been calculated, the steps for calculating expected annual damages for flooding from 2 to 3 feet are as follows:

1. Enter Figure V-5 at a flood depth of 3 feet. Because the floor elevation is 1017.5, the elevation for 3 foot flooding is 1020.5.
2. Find the point on the flood elevation curve corresponding to 1020.5. Move down to the frequency axis and find the corresponding flood frequency, 15 years.

**TABLE V-3
CALCULATIONS FOR EXPECTED
ANNUAL STRUCTURE DAMAGES**

Flood Depth Over Floor (a)	Frequency (years) (b)	Probability (Inverse of Frequency) (c)	Change in Probability (d)	Struct. Damage (%) (e)	Average Struct. Damage (%) (f)	Expected Annual Damage (%) (g)
0	1.2	0.08333		0		
0.5	1.8	0.55555	0.27778	5	2.5	0.694
1.0	2.8	0.35714	0.19841	10	7.5	1.488
2.0	4.5	0.15385	0.20330	19	14.5	2.948
3.0	15	0.06667	0.08718	27	23	2.005
4.0	35	0.02857	0.03810	31	29	1.105
5.3	100	0.01000	0.01857	37	34	0.631
TOTAL EXPECTED ANNUAL STRUCTURE DAMAGE = 8.871						
(percent of structure value or, \$/\$100 structure value)						

-
3. Compute the probability, $1/15 = .06667$. This is the probability that a flood greater than or equal to 3 feet will occur in any given year. (business) damages in the analysis of economic benefits to be obtained from flood protection.
 4. Compute the change in probability from the probability computed for the previous depth. The probability for the 2 foot or greater flood was 0.15385, so the change in probability is $0.15385 - 0.06667 = 0.08718$. This represents the probability in any given year of a flood between 2 and 3 feet.
 5. Enter Figure V-6 at the 3 foot depth and find the point on the structure curve at this level. Move down and find the corresponding damage value, about 27 percent.
 6. Calculate the average percent damage between this level and the preceding. The value for 2 feet was 19, so the average is $(27 + 19)/2 = 23$.
 7. Referring to Table V-3, multiply the probability in column (d) times the average damage in column (f) to find the expected damage, column (g). For the current step, $0.08718 \times 23 = 2.005$.

The sequence of steps described above must be repeated for each flood level (in feet) up to the Design Flood depth. By summing the values in column (g), the expected annual structure damage from all flooding (up to the Design Flood level) is obtained as a percentage of total structure value (or \$/\$100 structure value).

Assuming that the flood protection measures are 100% effective (to the Design Flood level), the values computed above represent the dollar benefits associated with damage reduction. (*Structural damage reduction in the case of the illustrated example.*)

Similar computations may be carried out for contents damage. Flood damages such as lost production time, sales, wages, uninsured losses, etc. cannot be included in this type of analysis unless they can be represented by a flood elevation-damage relationship. Because the latter damages may, in fact, be more significant than damages to the structure, it is important to carefully consider the non-structural

F. ANNUALIZED COSTS

Economics is not the only criteria for flood protection decision making. An economically unfeasible floodproofing program might still be desirable if floodproofing could significantly reduce non-quantifiable damages. After giving appropriate consideration to non-quantifiable benefits, however, it may also be desirable to examine economic feasibility.

If the economic benefits of floodproofing have been estimated, they may be compared with the costs of flood protection. The proposed floodproofing method will be economically feasible if the economic benefits are greater than the protection cost.

Economic benefits are generally calculated on an average annual basis. The major costs of floodproofing are generally estimated as total lump-sum costs that will occur when the structure is initially floodproofed. To compare annual benefits to costs, it is necessary to amortize the total initial project cost over the economic life of the structure.

The average annual cost depends on the amortization period and the applicable interest rate (see Table V-4 for amortization factors). Given the total initial floodproofing costs, the interest rate, and the amortization period (economic life of the floodproofing measures), an appropriate amortization factor can be determined. The annual cost is determined by dividing the total cost by the amortization factor.

As an example, let us assume that the total initial cost of a protective levee has been estimated at \$39,825. If a 30-year amortization period is selected at an interest rate of 10%, the average annual cost would be \$4,220 as shown below:

$$\frac{\text{Total Cost}}{\text{Amortization Factor}} = \text{Annual Cost}$$

or

$$\frac{39,825}{9.43} = 4,220$$

TABLE V-4
AMORTIZATION FACTORS

INTEREST RATE	AMORTIZATION PERIOD	
	30 YEARS	50 YEARS
6	13.76	15.76
7	12.41	13.80
8	11.26	12.23
9	10.27	10.96
10	9.43	9.91
12	8.06	8.30
14	7.00	7.13
16	6.18	6.25
18	5.52	5.55

G. SUMMARY

The costs of floodproofing can be divided into *primary costs* (the costs of the major floodproofing element(s): flood shields and closures, elevation, floodwall, levee) and *secondary costs* (other costs necessary for proper functioning of the floodproofing system). Estimated average primary costs and common secondary costs are summarized in Table V-5. Many secondary costs are too site specific for the reasonable estimation of representative values. Estimates for these costs must be developed from local sources and added to the cost estimates in this chapter.

**TABLE V-5
SUMMARY OF
FLOODPROOFING COSTS**

PRIMARY COSTS

ELEVATION

- Fill \$7.00 per cubic yard installed and compacted. See Figure V-1 for per square foot cost.
- Piles, posts, piers, walls \$6.40 per square foot of single story floor space.
- Raising existing structures
 - \$4.10 per square foot for a single story wood-frame structure.
 - \$8.10 per square foot for a single story brick or masonry structure.
 - \$12.90 per square foot for a single story slab-on-grade structure.

FLOOD SHIELDS

- Metal \$60 per square foot of opening. Also see Figure V-2.
- Plywood \$16 per square foot of opening

CLOSURES

\$45 per square foot of opening

FLOODWALLS

- 3' high \$110 per foot of length
- 5' high \$165 per foot of length
- 10' high \$410 per foot of length

LEVEES

- 3' high \$13 per foot of length
- 5' high \$30 per foot of length
- 10' high \$85 per foot of length (not zoned)
- 10' high \$300 per foot of length (zoned)

SECONDARY COSTS

- Extending Access/Utilities \$ 3.80 per square foot of single story floor space
- Erosion Protection \$22 per cubic yard of riprap
- Water-Proofing Walls/Floors \$ 1.85 per square foot of surface area
- Subfloor Drainage \$ 3.00 per square foot
- Periphery Drainage \$26 per linear foot
- Backflow Prevention Device \$720 installed
Concrete excavation extra \$ 105
Earth excavation extra \$ 27
- Testing Of Flood Shields \$150 to \$400

The economic benefits derived from the implementation of a floodproofing plan are represented by the reduction in the expected cost (in dollars) of future flood damages. Expected annual damages may be estimated using flooding depth-frequency data and the relationship of flooding depth to structure, contents, and other damages. The latter may be obtained from existing general information or may be estimated for the given location by knowledgeable personnel.

Ideally, the depth-damage relationship would quantify losses from decreased production, profits and wages, lost sales, flood fighting, flood cleanup, etc., which could be expected to occur if protective measures were not taken. It may even be possible to represent flood protection reductions in potential loss of life, injury, and short- or long-term health hazards by reductions in insurance premiums. The total initial project cost must be converted to an annual cost to allow a comparison with expected economic benefits. Initial cost can be converted to an annual cost by dividing by an appropriate amortization factor.

The following pages provide cost estimating forms which can be used to calculate the preliminary cost of the major flood protection alternatives discussed in this manual.

**PRELIMINARY COST ESTIMATE
STRUCTURE ELEVATION**

**TOTAL PRIMARY AND
SECONDARY COSTS (Sum of Above) = _____**

USING FILL:

Correction Factor: Current ENR
Construction Index/4194 x _____

Approximate Cubic Yards Required _____
X \$7.00 = _____
or
From Table V-6 = _____

Corrected Total Cost of Elevation
(Multiply by Two Numbers Above) = _____

USING PILES, POSTS, COLUMNS OR WALLS:

Single Story Floor Area _____ x \$6.40 = _____
If Elevated Less than 5 feet, Multiply by 0.93. = _____
If Elevated 5 to 7 feet, Multiply by 0.96 = _____
If Elevated 7 to 9 feet, Multiply by 1.00 = _____
If Elevated 10 feet, Multiply by 1.04 = _____

RAISING EXISTING STRUCTURE:

Wood Frame with Joist Floor:
_____ s.f. x \$4.10 = _____
Brick Veneer or Masonry with Joist
Floor: _____ s.f. x \$8.10 = _____

SECONDARY COSTS:

Lost Space Table V-7 (sq. ft.) _____
x Cost Per Sq. Ft. _____ = _____
or Lost Space (sq. ft./43560) (Acres)
x Cost per Acre _____ = _____

Extending Access and Utilities:

Square Feet of Single Story Floor Space
_____ x \$3.80 = _____
Insulating/Finishing Bottom of Buildings
on Piles, Columns, etc. (Insert Lump
Cost Based on Local Estimate) = _____
Erosion Protection (Table V-8) _____
cubic yards x \$22 = _____

**PRELIMINARY COST ESTIMATE
FLOOD SHIELDS/CLOSURES**

PRIMARY COSTS:

Metal Flood Shields Total Square
Footage of Openings to be Closed
_____ x \$60 = _____

Plywood Flood Shields Total Square
Footage of Openings to be Closed
_____ x \$16 = _____

Manufactured Shields Total Square
Footage _____ x Value from Figure V-2
_____ = _____

Permanent Closures Total Square
Footage of Openings to be Closed
_____ x \$45 = _____

SECONDARY COSTS:

Waterproofing: Surface Area (s.f.)
Walls and Floors Below Design Flood
Elevation _____ x \$1.85 = _____

Subfloor Drain:
New: Floor Area (S.F.) _____ x Value
from Figure V-4 = _____

Existing: Perimeter of Building (L.F.)
_____ x \$26 = _____

Backflow Prevention: Number of
Valves Required x \$720 = _____

Existing Sites: If Earth Excavation
Required, Add Number of Valves
_____ x \$27 = _____

If Concrete Excavation Required, Add
Number of Valves _____ x \$105 = _____

Testing: Number of Shields to be Tested
_____ x \$250 = _____

Flood Warning and Preparedness (insert
lump sum based on local estimate) = _____

**TOTAL PRIMARY AND
SECONDARY COSTS (Sum of Above) = _____**

Correction Factor: Current ENR
Construction Index/4194 x _____

Corrected Total Cost of Flood
Shields/Closures (Multiply Two
Numbers Above) = _____

**PRELIMINARY COST ESTIMATE
FLOODWALL OR LEVEE**

Access Through Floodwall/Levee:

Metal Shields:

Total Square Feet x \$60 = _____

Manufactured Shields:

Total Square Feet _____ x Fig. V-2
value _____ = _____

PRIMARY COST

Linear Feet of Floodwall/Levee _____
x Unit Cost (Table V-2) _____ = _____

**TOTAL PRIMARY AND
SECONDARY COSTS (Sum of Above) = _____**

SECONDARY COST

Backflow Prevention:

Number of Valves Required _____
x \$720 = _____

Existing Sites Add:

Earth excavation, number of valves
_____ x \$27 = _____

Concrete excavation, number of
valves _____ x \$105 = _____

Interior Drainage System: enter lump
sum including cost of pump,
grading, pump house, and other site
requirements. = _____

Correction Factor:

Current ENR Construction
Index/4194 = _____

Corrected Total Cost of Floodwall or
Levee
(Multiply two numbers above) = _____

Lost Space:

Side Slope

3h:1v H(ft) _____ x L(ft) _____ x 7 x Cost/Sq. Ft. = _____

2.5h:1v H(ft) _____ L(ft) _____ x 6 x Cost/Sq. Ft. = _____

2h:1v H(ft) _____ x L(ft) _____ x 5 x Cost/Sq. Ft. = _____

or, /43560 x Cost/Acre = _____

H = Levee Height

L = Levee Length

Erosion Protection:

Side Slope

3h:1v H(ft) _____ x L(ft) _____ x \$2.06 = _____

2.5h:1v H(ft) _____ L(ft) _____ x \$1.76 = _____

2h:1v H(ft) _____ x L(ft) _____ x \$1.46 = _____

H = Levee Height

L = Levee Length

COST OF ELEVATED FILL CONSTRUCTION

Table V-6 may be used to estimate the cost of stripping the base, placing and compacting a fill area. To use the table, first determine the area you will need for the structure and adjacent areas at the top of the fill. For instance, the structure may occupy 5000 square feet and you need 1400 feet around the building for traffic. The total area required is 6,400 square feet, and this is the number used in Table V-6. To estimate the cost of fill, enter the table in the section for $A \leq 10,000$, for this example, and move to the row corresponding to the height of elevation, say 8 feet. In this example we desire 3:1 side slopes, so we move under the column headed 3 and find the equation:

$$5,570 + 2.79 \cdot A = \text{Cost.}$$

For this example, the estimated cost for an 8 foot fill with a 6400 square foot top area is:

$$5,570 + 2.79 \times 6,400 = 523,400.$$

For areas larger than 10,000 square feet, use equations in the section $10,000 < A$ in a similar manner.

**TABLE V-6
COST OF FILL
(\\$)**

Area Required (Sq. Ft.)	Elevation Height (Ft.)	SIDE SLOPE, Z (Z h:1 v)		
		3	2.5	2
$A \leq 10,000$	4	$1,140 + 1.24 \cdot A$	$910 + 1.23 \cdot A$	$690 + 1.18 \cdot A$
	6	$2,840 + 1.97 \cdot A$	$2,220 + 1.90 \cdot A$	$1,660 + 1.83 \cdot A$
	8	$5,570 + 2.79 \cdot A$	$4,300 + 2.67 \cdot A$	$3,170 + 2.54 \cdot A$
	10	$9,540 + 3.70 \cdot A$	$7,310 + 3.51 \cdot A$	$5,330 + 3.31 \cdot A$
	12	$15,000 + 4.70 \cdot A$	$11,400 + 4.42 \cdot A$	$8,210 + 4.14 \cdot A$
$10,000 < A$	14	$22,100 + 5.78 \cdot A$	$16,700 + 5.41 \cdot A$	$11,900 + 5.03 \cdot A$
	4	$2,610 + 1.11 \cdot A$	$2,400 + 1.10 \cdot A$	$1,880 + 1.09 \cdot A$
	6	$6,040 + 1.69 \cdot A$	$5,470 + 1.66 \cdot A$	$4,260 + 1.63 \cdot A$
	8	$11,200 + 2.30 \cdot A$	$9,990 + 2.24 \cdot A$	$7,720 + 2.20 \cdot A$
	10	$20,100 + 2.91 \cdot A$	$16,100 + 2.85 \cdot A$	$12,400 + 2.78 \cdot A$
	12	$30,100 + 3.56 \cdot A$	$24,000 + 3.47 \cdot A$	$18,300 + 3.39 \cdot A$
	14	$42,600 + 4.25 \cdot A$	$33,700 + 4.13 \cdot A$	$25,600 + 4.01 \cdot A$

LOST SPACE

The lost space due to the outsoles of the fill may be estimated using Table V-7. Lost space is a function of the height of fill, (H), the slope of sides, (Z), and the usable area (A). Given the top area, say 6400 square feet as in the previous example, enter Table V-7 as the height of fill (8 feet in this example) and side slope (3 in this example), to find the estimating equation. For this example,

$$\text{lost space} = 2300 + 32.66 \times \text{SQR}(A),$$

where SQR(A) is the square root of the top area,

or

$$\text{lost space} = 2300 + 32.66 \times 80 = 4910 \text{ square feet.}$$

TABLE V-7 LOST SPACE (SQ. FT.)			
Elevation Height (Ft.)	SIDE SLOPE, Z (Z h:1 v)		
	3	2.5	2
4	$576 + 16.33 \times \text{SQR}(A)$	$400 + 16.33 \times \text{SQR}(A)$	$256 + 16.33 \times \text{SQR}(A)$
6	$1,296 + 24.49 \times \text{SQR}(A)$	$900 + 24.49 \times \text{SQR}(A)$	$576 + 24.49 \times \text{SQR}(A)$
8	$2,300 + 32.66 \times \text{SQR}(A)$	$1,600 + 32.66 \times \text{SQR}(A)$	$1,020 + 32.66 \times \text{SQR}(A)$
10	$3,600 + 40.82 \times \text{SQR}(A)$	$2,500 + 40.82 \times \text{SQR}(A)$	$1,600 + 40.82 \times \text{SQR}(A)$
12	$5,130 + 48.99 \times \text{SQR}(A)$	$3,600 + 48.99 \times \text{SQR}(A)$	$2,300 + 48.99 \times \text{SQR}(A)$
14	$7,060 + 57.15 \times \text{SQR}(A)$	$4,900 + 57.15 \times \text{SQR}(A)$	$3,140 + 57.15 \times \text{SQR}(A)$

COST OF RIPRAP

Required quantities of riprap for the fill may be estimated using Table V-8. Riprap volume is also a function of the height of fill, (H), the slope of the sides, (Z), and the usable area, (A). Again, using the top area of 6400 square feet as in the previous example, enter Table V-8 at the height of fill (8 feet in this example) and side slope (3 in this example) to find the estimating equation. For this example,

Riprap volume (cubic yards) $\geq 43.2 + 1.53 \times \text{SQR}(A)$,

where $\text{SQR}(A)$ is the square root of the top area, or

Riprap volume (cubic yards) $= 43.2 + 1.53 \times 80 = 166$ cubic yards.

**TABLE V-8
RIPRAP VOLUME
(CUBIC YARDS)**

Elevation Height (Ft.)	SIDE SLOPE, Z (Z hor v)		
	3	2.5	2
4	$10.8 + 0.77 \times \text{SQR}(A)$	$7.70 + 0.65 \times \text{SQR}(A)$	$5.10 + 0.54 \times \text{SQR}(A)$
6	$24.3 + 1.15 \times \text{SQR}(A)$	$17.2 + 0.98 \times \text{SQR}(A)$	$11.4 + 0.81 \times \text{SQR}(A)$
8	$43.2 + 1.53 \times \text{SQR}(A)$	$30.6 + 1.30 \times \text{SQR}(A)$	$20.3 + 1.08 \times \text{SQR}(A)$
10	$67.4 + 1.91 \times \text{SQR}(A)$	$47.8 + 1.63 \times \text{SQR}(A)$	$31.8 + 1.35 \times \text{SQR}(A)$
12	$97.1 + 2.30 \times \text{SQR}(A)$	$68.9 + 1.95 \times \text{SQR}(A)$	$45.8 + 1.62 \times \text{SQR}(A)$
14	$132.0 + 2.68 \times \text{SQR}(A)$	$93.8 + 2.28 \times \text{SQR}(A)$	$62.3 + 1.89 \times \text{SQR}(A)$

CHAPTER VI



TYPICAL APPLICATIONS OF FLOODPROOFING TECHNIQUES

A. INTRODUCTION

This chapter presents examples of non-residential floodproofing plans that have been designed and implemented in three cities within the United States. These examples have been included to illustrate the applicability of the techniques presented in this manual.

The three cities that were selected for study include Boulder, Colorado; Bristol, Connecticut; and Lock Haven, Pennsylvania. These cities are similar in that they each have a history of major flooding and extensive flood damages that has resulted in an interest in floodproofing techniques. Each city is participating in the National Flood Insurance Program, which requires floodproofing or elevation of all new non-residential construction in the floodplain in addition to all existing non-residential flood-prone structures that are substantially improved. The flood insurance studies conducted for these areas represented a major source of hydrologic data that was used in the design of floodproofing plans.

B. BOULDER, COLORADO

Boulder, Colorado was established in 1859 at the mouth of Boulder Canyon along Middle Boulder Creek. Floodplains in the area are subject to frequent and severe flash flooding associated with intense rainfall that occurs over a large, steeply sloped watershed. Floodwater velocities and floating debris content are relatively high in the area.

Boulder has experienced rapid development over the last few decades, with little or no floodplain management controls. A major flood in 1965 provided local residents with the incentive to participate in the National Flood Insurance Program and to develop and adopt floodplain regulations and an emergency warning system and evacuation plan. The flood warning system includes provisions for low cost radio activated alarms that can be placed at an individual structure. In addition, warning sirens are provided at neighborhood fire stations. This system allows the use of flood shields and other contingent floodproofing methods in certain areas of the city. The city also created a storm drainage and flood control utility district.

In 1969, following another major flood, the State of Colorado created an Urban Drainage and Flood Control District to coordinate flood damage abatement programs and provide technical and financial assistance to communities. Boulder was selected as a pilot study area for the District. This program has resulted in the design and construction of a significant number of floodproofed structures in the Boulder area. Seven examples of these floodproofing efforts are briefly described on the following pages. Floodproofing techniques that are illustrated include the use of elevation, flood shields, and levees.



**Columbia Savings and Loan
Boulder, Colorado**

The Columbia Savings and Loan building is an attractive concrete and glass facility with a metal roof. The 5,055 square foot building is elevated on four main columns. The use of floodproofed space below the structure for a drive-through teller facility reduced total site size requirements and associated land acquisition costs. The first floor level has been elevated 14 feet above the ground, one foot above the base flood elevation. Elevation represented the only feasible floodproofing option at this site due to the significant flooding depth.

The cost of elevating this structure was approximately \$77,000 (1970) which included the columns, stairs, elevator, utility extensions, and surfacing the bottom of the elevated floor area.



Area beneath the building provides sheltered space for automatic bank teller facility.



The entire structure is elevated with the exception of glass entry areas.

**Emily Lawrence, Ltd.
Boulder, Colorado**

Anticipated flood depths at the Emily Lawrence, Ltd. site were less than 3 feet, with floodwater velocities of 2 feet per second. It was determined that elevation on fill was the most cost effective and desirable floodproofing alternative for the site. The 5,500 sq. ft. brick veneer building is constructed on a concrete slab foundation. The first floor level has been elevated approximately 2.5 feet above the base flood elevation. The location of the building on the edge of the floodplain fringe allowed final grading that provides direct access to the first floor in the front of the building. A combination of grassed embankments and retaining walls were used to accommodate a relatively steep grade transition at the back of the structure. Floodproofing costs, including delivery and compaction of the fill material and additional site preparation, were approximately \$15,000 (1980).



Site grading provides direct access to first floor elevation at the front of the structure.



Combination of grass embankments and retaining walls to accommodate grade change at rear of the structure.

**JLS Professional Building
Boulder, Colorado**

The JLS Professional Building is a two-story structure constructed of glass, steel, concrete and brick veneer. The building was elevated on walls and columns to provide parking space and to protect against flood damage. The first floor elevation is about 6 feet above the base flood elevation. Expected flood depths at this site are 3 feet with flow velocities of 2 feet per second. Elevation increased the cost of the building by 20-35%, however the benefits associated with parking space below the structure compensated for this cost increase. The total structure cost was approximately \$500,000 (1980). The first floor area of this building is approximately 4,750 square feet.



Extensive parking space has been provided beneath this elevated structure.



Building materials include combination of glass, steel, concrete and brick veneer.

**Safeway Building
Boulder, Colorado**

The Safeway building has a brick veneer exterior with a standing metal seam roof. All windows are located above the base flood elevation, which is approximately equal to the finished floor elevation. Therefore, flood shields only designed to protect only the doors. Flood velocities in the area are approximately 2 feet per second. The shields are equipped with a pneumatic watertight sealing system, and vary in size from 40 inches to 166 inches wide by 26 inches high. The shields are stored near the front of the store behind the shopping cart storage area where they are convenient in case of flooding. The 8 shields provided for the site were manufactured by the Prestay Corporation for a total cost of \$22,650 (1981).



Existing Safeway Building has been retrofitted with flood shields to protect against flood depths up to 2 feet above the 1st floor elevation.



Stored flood shields (Note pneumatic seal valves).



Detail of frame used for mounting shield at front door.

**Eastpark Building
Boulder, Colorado**

The Eastpark is a fluted concrete block building used for manufacturing and storing office furniture. The finished floor level is approximately equal to the base flood elevation, and flood velocities are estimated at 2 feet per second. All windows at the site are well above the flood level; therefore only doors have been fitted with flood shields. Bolt-on shields were fabricated by a local metal working firm (Boulder Steel) to floodproof this existing structure. A total of 18 shields are required to protect the structure. Ten of these shields are 3 feet wide, and 8 of the shields are 10 feet wide. All shields are 3 feet in height. The total cost of the shields was \$3,400 (1980).



Door frames for mounting flood shields at personnel door.



Floodproofing requires installation of 18 flood shields to protect 8 vehicular entrances and 10 personnel doors.

**Commonwealth Office Building
Boulder, Colorado**

The Commonwealth Office building is a three-story stuccoed precast concrete structure. The finished floor level at this site is approximately 3 feet below the base flood level. Floodproofing of this existing structure required 5 flood shields. The shields are 48 inches high and range from 3-4 feet in width. The shields are designed to withstand 3 feet of flooding depth. The shields were manufactured by Boulder Steel. The total cost of shields at this site was \$1,750 (1978).



Structure can be floodproofed with a total of 5 flood shields.



Small courtyard area is protected by combination of precast concrete wall and flood shield at door opening.



Flood shield in storage position adjacent to opening it is designed to protect.

**Moore and Company
Boulder, Colorado**

The Moore and Company building is located in an area that presented an opportunity to floodproof with an earthen levee. Secondary benefits were derived from the landscaping features incorporated in the design of the levee and building. The base flood elevation at this site is approximately 8 feet above the finished basement floor level, however the levee provides protection to an elevation 2 feet above the base flood level. Therefore, the levee protects both the basement and first floor (a total of 9,800 square feet). The three-story brick veneer building has a walkout basement that opens onto a courtyard that is enclosed by the levee. Access to the front of the building is provided by concrete steps that provide the same level of flood protection as the levee. The total cost of the levee on three sides of the building was approximately \$5,000 (1980).



Front entrance is protected from flooding by concrete steps.



The skillful mixing ground cover and grass planting reduce the visual impact of the levee structure.



View of Moore and Company plaza area from top of levee.

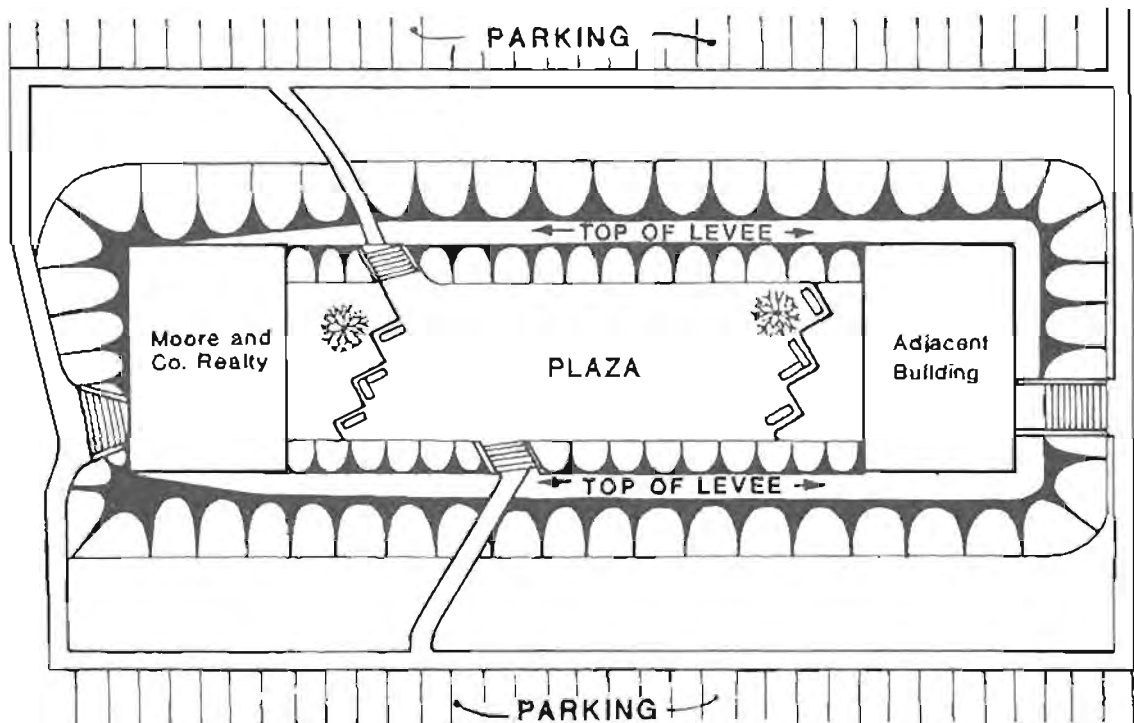

Site plan for Moore and Co. Realty. Note that levee protects two structures and provides a heavily landscaped and enclosed central plaza area.

C. BRISTOL, CONNECTICUT

A considerable number of structures have been floodproofed in Bristol, Connecticut. However, this manual will focus on the Wallace Barnes Steel Company. This site was selected because of the company's interest in floodproofing techniques, which has resulted in the construction of a broad range of floodproofing techniques throughout the plant.

A portion of the Pequabuck River channel was diverted in 1946, and the Wallace Barnes facilities have been constructed on the old river bed. During normal flow levels, portions of the plant are only 5 vertical feet above the relocated river water surface; and buildings within the area are subject to 2-4 feet of flooding during a 100-year flood. In 1955 and 1975 major floods resulted in extensive damage to the steel plant.

Recognizing that plant relocation was not economically feasible, the Wallace Barnes Steel Company retained the firm of Anderson-Nichols to perform a floodproofing feasibility study for the complex. The study identified a wide range of permanent, contingent, and emergency floodproofing techniques that could be used to reduce flood damages. Suggested techniques included the use of floodwalls, earthen levees, flood shields, drainage systems, sump pumps, utility system protection, permanent closures, and elevation. The advantages and disadvantages of alternative approaches were identified in the study, in addition to the cost of proposed techniques.

After some modification to the initial floodproofing plans Wallace Barnes management adopted and began to implement a floodproofing program. The selected measures included permanent closure of two coal loading bins, floodwalls designed to protect open spaces between buildings and a below-grade doorway, bolt-on flood shields to protect a total of 61 openings, and replacing an old wooden wall in one building with a 4 foot high concrete wall topped with a frame wall with metal siding. Also, a new addition to the plant was elevated above the base flood level, and a foundation drainage system was installed to relieve uplift pressure on the existing concrete slab floors.

All flood shields and openings have been clearly labeled with symbols that are classified by color and shape. This classification system specifies the location of all shields, and installation priorities. The code numbers are illustrated on a graphic master plan that is maintained by all plant supervisors.

Several locations have been designated throughout the plant for floodproofing component and equipment storage. Sandbags are stored on raised pallets that can be transported by fork lift equipment. Emergency gasoline powered pumps are also stored at these locations and a routine maintenance program assures that all systems are operational. The floodshields for individual openings are stored as close to the openings as possible and the tools for mounting them are stored at a common site.

To assure that sufficient personnel are available to implement the floodproofing measures, Wallace Barnes conducts regular training sessions for all supervisors and maintenance people. All supervisors maintain a copy of the Floodproofing Operations Manual which shows all implementation requirements and material storage locations. Because there are maintenance personnel in the boiler building near the river, the monitoring of the river staff gage is assigned as a routine task during potential flood conditions. The floodproofing measures have been prioritized so that the installation crew can implement the plan in phases as required to protect against various flooding conditions.

There has been one flood at the Wallace Barnes site since the floodproofing improvements were completed. This flood occurred on June 5, 1982. The event resulted in flooding of only two non-floodproofed buildings within the complex. Maintenance personnel in the boiler building began to monitor the river staff gage at 12:00 p.m. At 6:00 p.m., company management decided to implement appropriate floodproofing measures. A four man crew installed all system components by 8:00 p.m., the river peaked at 10:00 p.m., and floodwaters subsided by 12:00 p.m. Test ports were monitored throughout the flood, but hydraulic pressure beneath the floors was not elevated to significant levels since the floodwaters receded very quickly. Therefore, it was not necessary to close floor drain valves, or to

activate the pumps connected to the foundation drainage system.

This flood did not result in any damages to the Wallace Barnes site with the exception of minor exterior cleanup requirements. For comparison purposes, it is significant to note that a brass rolling mill is located near the Wallace Barnes site. Operations at this facility are comparable to those at Wallace Barnes, and the brass rolling mill was subjected to comparable flood depths. Because the mill did not have any provisions to reduce flood damages, the facility sustained close to \$1 million in flood damages.

With the exception of engineering services, the total cost of floodproofing measures at the Wallace Barnes site was approximately \$250,000 (1980). The company has been able to recover this cost through reduced flood insurance rates, and damages prevented during the June 5, 1982 flood.



Tools, parts, and portable gas powered pumps required to install flood shields and remove any seepage that may occur.



Sand bags stored on pallets that can be moved to site by fork lifts.



Floodproofed on-site gasoline pump to provide fuel for portable pumps and other equipment.



Concrete cap used to seal abandoned coal loading chute.



Reinforced concrete wall to protect below grade door (steps extend to top of the wall and down to Ground level).



Flood shield are maintained in place over seldom-used openings.

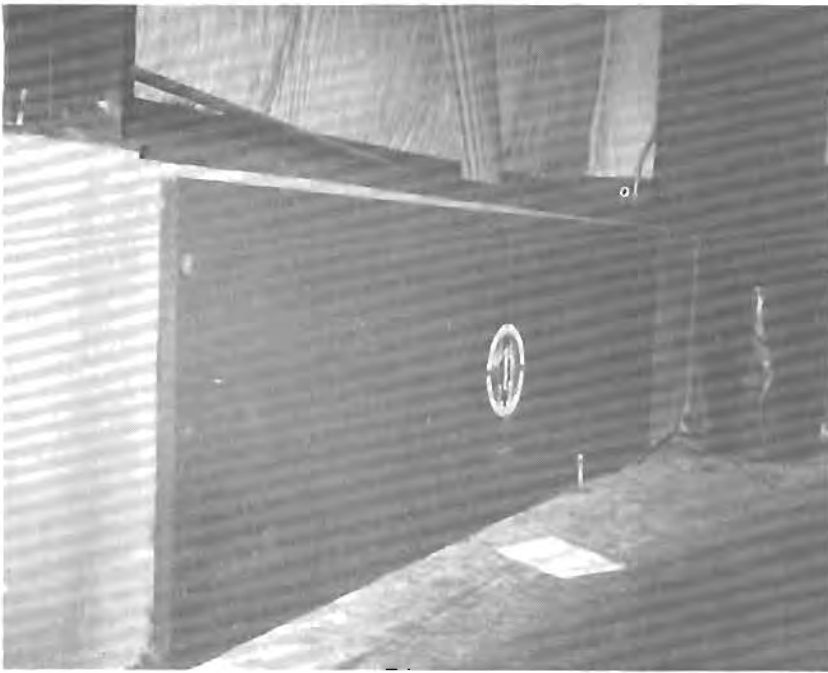

Flood shield in stored position. Can be raised to protect large loading dock door.



Shield Detail

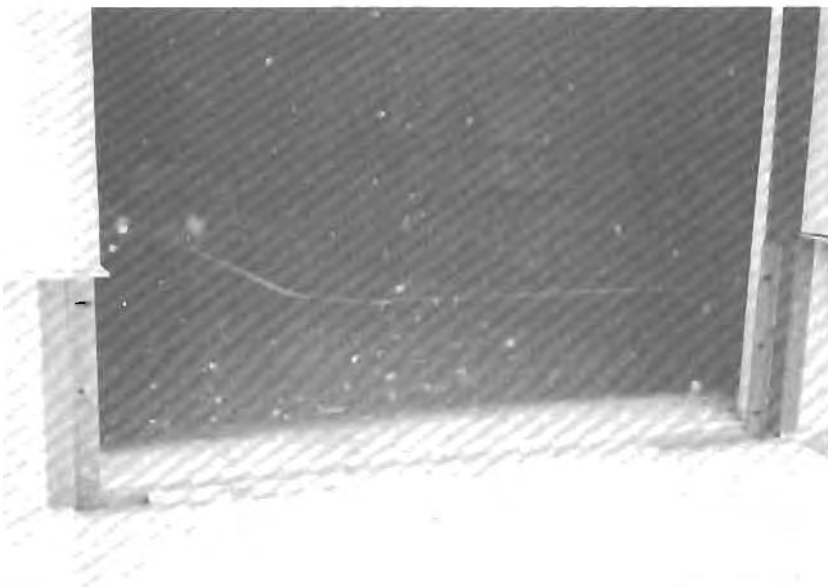

Frame for mounting flood shield on loading dock door. A 4" x 4" piece of timber is used to facilitate traffic over a slot designed to receive and seal the flood shield.



Frame Detail



Diesel pump which can be used to dewater seepage within the plant and from a below grade collector system on the perimeter of the plant that is designed to reduce uplift forces on the floor system.



Newly constructed computerized rolling mill area has been elevated above the base flood elevation.

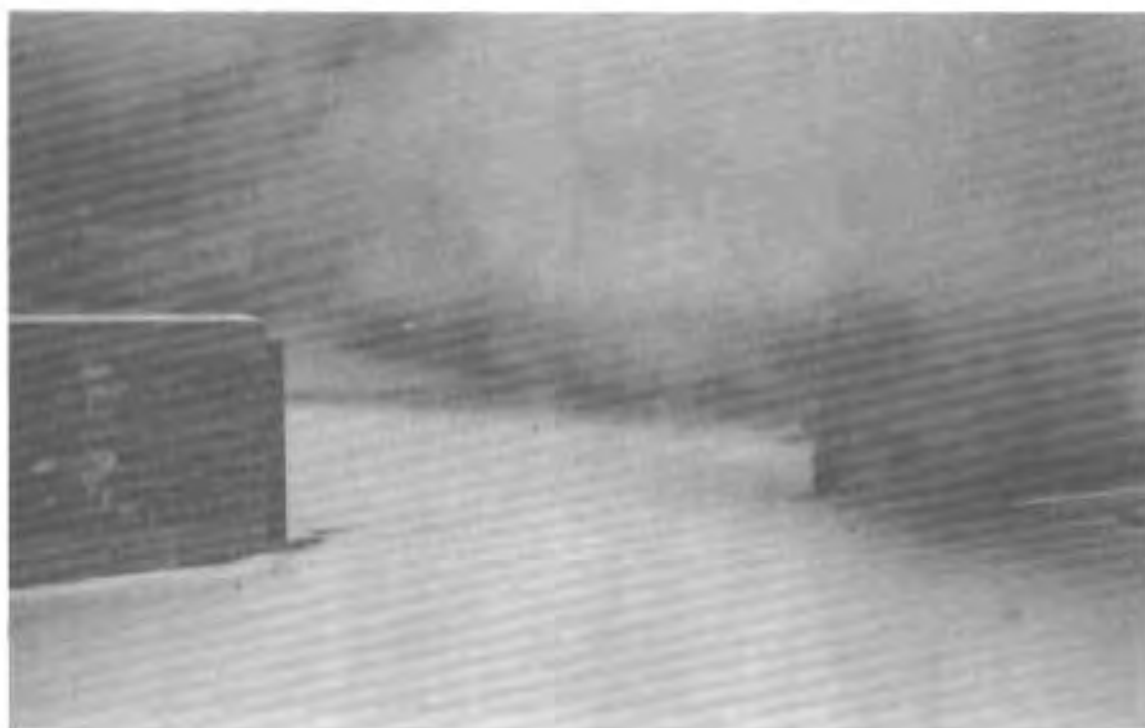

Floodwall to protect large area **between two buildings.**



Frame for mounting flood shield at access point through floodwall.

D. LOCK HAVEN, PENNSYLVANIA

The city of Lock Haven is located in Clinton County in central Pennsylvania. The West Branch of the Susquehanna River flows through the north portion of the city, and Bald Eagle Creek flows through the south section. The combined drainage area of these two watersheds is approximately 3,117 square miles. Previous flood studies have shown that approximately 60% of the town lies within the 100-year floodplain. Furthermore, a large percentage of development within the floodplain is located in the floodway where depths exceed 8 feet, and velocities exceed 3 fps. The city has been flooded 19 times in the past 130 years. The flood of record occurred in 1972 as a result of Tropical Storm Agnes (estimated as a 140-year flood) in Lock Haven.

As a result of obvious flood hazards, the City of Lock Haven and Clinton County have initiated a floodplain management program. Historical flood problems which were highlighted by Tropical Storm Agnes led to the involvement of a complex network of government agencies at the Federal, State, regional and local levels, all working toward means of reducing flood damages in Lock Haven. The result has been the floodproofing of a considerable number of both residential and non-residential structures in the area.

In response to extreme flood depths, the most common floodproofing technique that has been applied in Lock Haven is structure elevation. The floodproofing examples shown in this chapter illustrate the flexibility of elevation as it applies to several building types in an area that is subjected to extreme flood hazards. The sites described below illustrate that elevated structures can be functional, cost effective, and aesthetically pleasing.

Kephart Plaza Lock Haven, Pennsylvania

The Kephart Plaza is a five-story cast-in-place concrete structure with a brick veneer exterior. Base flooding depth associated with the 100-year flood is approximately 9 feet. The ground elevation at the site is 557 msl and the finished floor elevation is 567 msl which places it about 1 foot above the base flood elevation. All utilities have been elevated to the first floor and access to the building is provided by stairs and an elevator. Floodproofing costs, including elevation of the utilities, was about \$100,000 (1979) or 5% of the total project cost. The open space beneath the building is utilized for parking, storage and picnic facilities. Flood warnings at this site are issued from warning sirens at a nearby fire station.



Structure elevated on columns and walls



Front entrance at Kephart Plaza.



Area under the structure is used for outdoor activities and storage.

**Ross Library
Lock Haven, Pennsylvania**

The Ross Library building is a 2-story cast-in-place structure with a brick veneer exterior. Because of the need in this case to reduce the impact of building placement on the floodwater depth or flow, the front and one side of the building have been elevated on walls and the balance of the structure is supported by columns. The first finished floor has been elevated approximately 12 feet, 7 feet above the base flood elevation, to reflect the severe losses that would be incurred at the library if a flood exceeded the 100-year level. The cost of elevation was approximately \$100,000 (1978).



Combined use of wall and columns minimize visual impacts of 12 foot elevation height.



Structure has been elevated 7 feet above the base flood level in recognition of potential damage from floods that exceed the regulatory flood level.

**Centre Concrete
Lock Haven, Pennsylvania**

The Centre Concrete Company is located in the flood fringe. Two buildings have been constructed on fill at the Centre Concrete site including a 6,150 square-foot control building and a 6,400 square-foot garage. The control building is of concrete block construction and is supported by fill which has been placed behind a concrete retaining wall. The garage is a four-bay metal building on a concrete slab-on-grade foundation. Support facilities such as conveyors are elevated on concrete columns. The base flood elevation at this site is approximately 10 feet above the original ground elevation. The cost of additional fill for the site was \$6.00 per cubic yard for a total cost of approximately \$120,000 (1981)



Garage structure elevated on earth fill.



Control building is elevated on earth fill that is enclosed by concrete retaining walls. This technique minimizes space requirements because areas for slope transition are not required.

ELEVATION ON FILL

American Legion Hall Lock Haven, Pennsylvania

The American Legion Hall in Lock Haven is a concrete block building that has been elevated approximately 10 feet on fill. The finished floor is located one foot above the base flood elevation. Earth fill was delivered to the site at a cost of \$2.00 per cubic yard for a total cost of \$4300 (1979), or 3% of the total building cost of \$150,000 (1979).



Structure elevated approximately 10 feet on earth fill for approximately 3% of the total project cost.

APPENDICES



APPENDIX A BIBLIOGRAPHY

BOOKS & GOVERNMENT PUBLICATIONS

I. Design and Construction Manuals

- American Wood Preserves Institute, National Forest Products Association, and Southern Forest Products Association, "How to Build Storm Resistant Structures." N.p., n.d.
- Black, Richard D. *Flood Proofing Rural Residences*. A "Project Agnes" Report. Washington, D.C.: Economic Development Administration, 1975
- Carling, John G.; Kvaternik, William; and Carrier, Roger E. *Handbook of Flood-Resistant Construction Specifications*. N.p.: Pennsylvania Department of Community Affairs, Bureau of Housing and Development, Disaster Protection Division, 1976.
- Carrier, Roger E. *Flood Forces Associated with Flood Resistant Construction*. Pittsburgh: N.p., n.d.
- Chow, Ven Te. *Open-Channel Hydraulics*. New York: McGraw-Hill Book Company, 1959.
- Department of the Interior Bureau of Reclamation. *Design of Small Dams*, 1977.
- Federal Emergency Management Agency. *Design and Construction Manual for Residential Buildings in Coastal High Hazard Areas*. Washington, D.C.: U.S. Government Printing Office, 1981.
- Federal Emergency Management Agency. *Design Guidelines for Flood Damage Reduction*. Washington, D.C.: U.S. Government Printing Office, 1981.
- Federal Emergency Management Agency: *Elevated Residential Structures*. Washington, D.C., U.S. Government Printing Office, 1984 (revised).
- Federal Emergency Management Agency, Federal Insurance Administration. *Design Manual for Retrofitting Floodprone Residential Structures*. (to be published Summer 1986).
- Federal Emergency Management Agency, Federal Insurance Administration, *Technical Standards Bulletin 85-1: Wet Floodproofing*, September 1985.
- Federal Emergency Management Agency. *Manual for the Construction of Residential Basements in Non-Coastal Flood Environs*, March 1977.
- Fulcher, Jerry. *Flood Proofing*. Lansing, Michigan, 1981. (Photostatic reproduction).
- Henderson, F.M. *Open Channel Flow*. New York: The Macmillan Company, 1966.
- Illinois Division of Water Resources. *Protecting Your Home from Flood Damage*. Chicago: Illinois Division of Water Resources, 1982.
- Morris, Henry M. and Wiggert, James M. *Applied Hydraulics in Engineering*, Second Edition. New York: The Ronald Press Company, 1972.
- Office of Lieutenant Governor (Massachusetts) Thomas P. O'Neill, III. *A Coastal Homeowner's Guide to Floodproofing*. Boston: N.p., n.d.
- Pennsylvania Department of Community Affairs Bureau of Housing and Development Disaster Project Division, *The Handbook of Flood-Resistant Construction Specifications*, December 1976.



Prestay Corporation. *Prestay Flood Protection Products*. Pawling, N.Y.: The Prestay Corp., n.d.

Tracy, Robert L. *A Model Building Code of Floodproofing Regulations for Zoned Flood Areas*. Master of Civil Engineering Dissertation, Catholic University of America, Washington, D.C., 1971.

U.S. Army Corps of Engineers. *Design and Construction of Levees - Engineering Manual 1110-2-1913*.

U.S. Army Corps of Engineers. *Flood Walls Engineering Manual 110-2-2501*.

U.S. Army Corps of Engineers. *Hydraulic Design of Flood Control Channels Engineering Manual 1110-2-1601*.

U.S. Army Corps of Engineers, New England Division. *Floodproofing: A Guide to Property Owners*. N.p., 1981.

U.S. Army Corps of Engineers, South Atlantic Division. *Flood Proofing: Example of Raising a Private Residence*. N.p., 1977.

U.S. Army Corps of Engineers, Vicksburg District. *Description of a Folding Floodwall Built at Ouchita Parish, Louisiana*. N.p., n.d.

U.S. Army Corps of Engineers, Vicksburg District, Waterways Experiment Station. *Systems and Materials to Prevent Floodwaters from Entering Buildings*, May 1985.

U.S. Army Corps of Engineers, Vicksburg Waterways Experiment Station. Pace, Carl E. and Campbell, Roy L. *Structural Integrity of Brick Veneer Buildings*. Vicksburg, Ms.: U.S. Waterways Experiment Station, 1978.

U.S. Army Corps of Engineers, Vicksburg Waterways Experiment Station. Pace, Carl E. *Tests of Brick Veneer Walls and Closures for Resistance to Floodwaters*. Vicksburg, Ms.: U.S. Waterways Experiment Station, 1978.

U.S. Department of the Navy. *Soil Mechanics, Foundations and Earth Structures*, NAVFAC DM-7, March 1971.

U.S. Department of Transportation. *Use of Riprap for Bank Protection*. Washington, D.C.: U.S. Government Printing Office, 1970.

Webb, Robert P. and Burnham, Michael W. *Spatial Data Analysis of Nonstructural Measures*.

2. ECONOMIC FEASIBILITY ANALYSIS

Dames and Moore. *Draft Floodproofing Cost Study, Tug Fork River Basin*. Washington, D.C., 1980. (Photostatically reproduced).

Federal Emergency Management Agency. *Economic Feasibility of Floodproofing--Analysis of a Small Commercial Building*. Washington, D.C.: U.S. Government Printing Office, 1979.

James, L. Douglas. *Economic Analysis of Alternative Flood Control Measures*. Kentucky Water Resources Institute Research Report No. 16, Lexington, Kentucky: University of Kentucky, Water Resources Institute, 1968.

Murray, Martin L. *Cost Study Floodproofing in the Cameron, South Harrisburg and Penn Susquehanna Urban Renewal Areas*. Harrisburg, Pennsylvania: n.p., 1974 (Photostatically reproduced).

U.S. Army Corps of Engineers, Baltimore District. *Cost Report on Non-Structural Flood Damage Reduction Measures for Residential Buildings Within the Baltimore District*. Ft. Belvoir, VA: U.S. Institute for Water Resources, 1977.

U.S. Army Corps of Engineers, Carson, William D. *Estimating Costs and Benefits for Nonstructural Flood Control Measures*. Davis, California: Hydrologic Engineering Center.

U.S. Army Corps of Engineers, Chicago District. *Chicagoland Underflow Plan: Preliminary Cost Estimates for Nonstructural Plan Formulation*. N.p., 1981.

U.S. Army Corps of Engineers, Hydrologic Engineering Center. *Costs of Placing Fill in a Flood Plain*. Davis, California: Hydrologic Engineering Center, 1975.

U.S. Army Corps of Engineers, New England Division. *Connecticut River Basin Feasibility Study of Nonstructural Flood Damage Reduction Measures*. N.p., 1981.

Vierling, Steve. *Report on the Initial Costs of Non-Structural Alternative for the Protection of Evacuation of Existing Structures within a Flood Plain*. Louisville, Kentucky, 1976. (Photostatically reproduced.)

3. FLOOD DAMAGE REDUCTION

Bristol Flood Study Commission. *Plan for Flood Damage Prevention at Bristol, Tennessee-Virginia*. N.p., 1962.

Flood Loss Reduction Associates. *Cooperative Flood Loss Reduction: A Technical Manual for Communities and Industry*. Washington, D.C.: U.S. Government Printing Office, 1981.

Lower Meramec Valley Flood Damage Reduction Study Team. *Out of Harm's Way: Lower Meramec Valley Flood Damage Reduction Study*. N.p., 1981.

Soil Conservation Service, U.S. Department of Agriculture. *Planning Nonstructural Measures for Flood Damage Reduction*.

U.S. Army Corps of Engineers. *Guidelines for Reducing Flood Damages*. Vicksburg, Ms.: Army-MRC, 1967.

Weathers, John W., ed. *Flood Damage Prevention: An Indexed Bibliography*. Knoxville, Tennessee: Tennessee Valley Authority and University of Tennessee Water Resources Research Center, 1976.

4. FLOODPLAIN MANAGEMENT

Flood Loss Reduction Associates. *Floodplain Management Handbook*. Washington, D.C.: U.S. Government Printing Office, 1981.

Lally, Nicholas. *Floodproofing and Flood Plain Management: Federal Insurance Administration Viewpoints and Directions*. A paper presented at the Conference on Floodproofing and Flood Plain Management, Pacific Grove, California, March 20-25, 1977. (Photostatically reproduced.)

Owen, H. James. *Annotations of Selected Literature on Nonstructural Floodplain Management Measures*. Washington, D.C.: U.S. Government Printing Office, 1977.

U.S. Army Corps of Engineers, Hydrologic Engineering Center. Johnson, William K., ed. *Physical and Economic Feasibility of Nonstructural Floodplain Management Measures*. Washington, D.C.: U.S. Government Printing Office, 1978.

U.S. Army Corps of Engineers, Hydrologic Engineering Center and the Institute for Water Resources. *Proceedings of a Seminar on Nonstructural Floodplain Management Measures*. Washington, D.C.: U.S. Government Printing Office, 1976.

5. FLOODPROOFING

Akili, Petros, and Willis, Cleve E. *Flood Proofing Decisions Under Uncertainty: An Application to the Connecticut River Basin*. Springfield, VA.: National Technical Information Service, 1973.

Coxliran, Anita L. *Bibliography on Floodproofing*. Boulder, Colorado: Natural Hazards Research and Applications Information Center, 1977.

Colorado Water Conservation Board, Colorado Department of Natural Resources. *Colorado Floodproofing Manual*, October 1983.

Dexter, James R.; Willeke, Gene E.; and James L. Douglas. "Social Aspects of Flood Proofing." Reprinted from the Proceedings of the Specialty Conference on Legal, Institutional and Social Aspects of Irrigation and Drainage and Water Resources Planning and Management at Blacksburg, Virginia, July 26-28, 1979.

The Hartford Insurance Group. *Floodproofing: A Technique of Avoiding Flood Damage*. Hartford, Connecticut: The Hartford Insurance Group, n.d.

James F. MacLauren Limited. *Flood Proofing: Component of Flood Damage Reduction--Portfolio of Case Studies*. N.p., 1978.

Jones, D. Earl, Jr. *Early Floodproofing Limitations and the Fairbanks Contribution*. Washington, D.C. (Photostatically reproduced.)

U.S. Army Corps of Engineers, Office of the Chief of Engineers. *Floodproofing Regulations*. Washington, D.C.: U.S. Government Printing Office, 1972.

Sheaffer, John R. *Floodproofing: An Element in a Flood Damage Reduction Program* Chicago: The University of Chicago Press, 1960.

Sheaffer, John R. *Introduction to Floodproofing: An Outline of Principles and Methods*. Chicago: Center for Urban Studies, University of Chicago, 1967.

Soll Conservation Service, U.S. Department of Agriculture. *Floodproofing*, N.p., 1975.

U.S. Army Corps of Engineers, Baltimore District. *Existing Flood-Proofed Structures Within the Baltimore District*. N.p., 1980. (Photostatically reproduced.)

U.S. Army Corps of Engineers, Chicago District. *Inventory of Floodproofing Activity Within the Chicago District*. Chicago, 1980. (Photostatically reproduced.)

WBDC, Inc. *Floodproofing Criteria: Proposed Hotel, Grand Rapids, Michigan*. N.p., 1981.

6. FLOOD WARNING/PREPAREDNESS

Bresenhan, Thomas P. *Industrial Flood Preparedness: Proceedings of the Flood Warning and Floodproofing Seminar for Industry*. Lewisburg, Pa.: SEDA-Council of Governments, 1979.

Federal Committee for Meteorological Services and Supporting Research. *A Federal Plan for Natural Disaster Warning and Preparedness*. Washington; U.S. Department of Commerce, National Oceanic and Atmospheric Administration, 1973.

Owen, H. James, and Wendell, M. *Community Handbook on Flood Warning and Preparedness Programs*. Springfield, Virginia: National Technical Information Service, 1981.

Owen, H. James, and Wendell, M. *Effectiveness of Flood Warning and Preparedness Alternatives*. Springfield, Virginia: National Technical Information Service, 1981.

Owen, H. James, and Wendell, M. *Implementation Aspects of Flood Warning and Preparedness Planning Alternatives*. Springfield, Virginia: National Technical Information Service, 1981.

7. GENERAL RESOURCES

Booker Associates, Inc. *Kentucky Flood Protection Manual*. Lexington, Kentucky: Booker Associates, Inc. for the Kentucky Department for Local Government, 1982.

Connecticut Department of Environmental Protection. *Flood Hazard Mitigation: A Manual for Connecticut Municipalities* (Booker Associates, Inc. had access to only an excerpt from this study containing the section on floodproofing. Therefore, location and name of the publisher are not known, nor is the date of publication.)

James, L. Douglas. "Formulation on Nonstructural Flood Control Programs." *Water Resources Bulletin* 11 (August 1975): 688-705.

Kerns, Waldon R., ed. *Implementation of Non-Structural Alternatives in Flood Damage Abatement*. Blacksburg, Va.: Virginia Water Resources Research Center, 1977.

Manitoba Flood Control Headquarters. *Manitoba Flood Information*. N.p., n.d.

Platt, Rutherford. *Consultant Report: Options to Improve Federal Non-Structural Response to Floods*. Springfield, Virginia: National Technical Information Service (NTIS), 1979.

U.S. Army Corps of Engineers, Baltimore District. *Susquehanna River Basin Flood Control Review Study*. N.p., 1980.

White, Gilbert F. *Flood Hazard in the United States: A Research Assessment*. Springfield, Virginia: National Technical Information Service (NTIS), 1975.

8. NON-STRUCTURAL CASE STUDIES

- Ackenheil and Associates Geo Systems, Inc. *Nonstructural Floodplain Management Study, Little Grave Creek Watershed, Marshall County, West Virginia*. Hyattsville, Md.: U.S. Soil Conservation Service, 1978.
- Beyers, William B., et. al. *Nonstructural Approaches to the Management of the Snohomish River Basin Flood Hazard*. N.p., 1980.
- Booker Associates, Inc. *Report of Nonstructural Floodplain Management Alternatives: Stewart Creek Watershed, Hopkins County, Kentucky*. N.p., 1977.
- TSP Engineers, Inc. and Weichsebaum and Associates, Inc., Architects. *Floodproofing Study of Five Municipal Buildings for the City of Rochester, Minnesota*. N.p., 1980.
- U.S. Army Corps of Engineers, Baltimore District. *Floodproofing Recommendations for Avies Fibers, Inc.* Baltimore, n.d. (Photostatically reproduced.)
- U.S. Army Corps of Engineers, Baltimore District. *Floodproofing Recommendations for Londontown Corporation*. Baltimore, n.d. (Photostatically reproduced.)
- U.S. Army Corps of Engineers, Baltimore District. *Floodproofing Recommendations for I. Sekine Company, Inc.* Baltimore, n.d. (Photostatically reproduced.)
- U.S. Army Corps of Engineers, Baltimore District. *Floodproofing Recommendations for Poole Company*. Baltimore, n.d. (Photostatically reproduced.)
- U.S. Army Corps of Engineers, Mobile District. *Floodproofing City Hall, Bayou La Batre, Alabama*. Mobile, Ala.: Corps of Engineers, 1973.
- Weeks, Archie D. "Stewart Creek Non-Structural Study." A paper for presentation at the 1979 Winter Meeting of the American Society of Agricultural Engineers. (Photostatically reproduced.)

MAGAZINES & PROFESSIONAL JOURNALS

1. ECONOMIC FEASIBILITY ANALYSIS

- Flack, Ernest J. "Economic Analysis of Structural Floodproofing." *American Society of Civil Engineers Proceedings*, 104 (WR 1 No. 14185) (November 1978): 211-21.
- Johnson, Nolan L., Jr. "Economics of Permanent Flood-Plain Evacuation." *American Society of Civil Engineers Proceedings* 102 (IR 3 No. 12178) (September 1976): 273-83.

2. FLOOD DAMAGE REDUCTION

- "Fighting Floods with Bags of Water." *Product Engineering* (September 25, 1967): 30.
- "Fight Floods with Mud and Water." *Civil Engineering* 50 (November 1980): 24.
- Lardieri, Armando C. "Floodproofing Regulations for Building Codes." *American Society of Civil Engineers Proceedings* 101 (HY 9 No. 11576) (September 1975): 1155-69.
- Noble, Ronald M. "Flood Protection of Crystal River Unit 3 Nuclear Plant." *American Society of Civil Engineers Proceedings* 101 (PO 1 No. 11458) (July 1975): 85-94.
- O'Connor, James J. "How to Hold Flood Damage in Line." *Power*, 123 (January 1979): 62-5.
- Weather, John W. "Comprehensive Flood Damage Prevention." *American Society of Civil Engineers Proceedings* 91 (HY 1 No. 4193) (January 1965): 17-27.

3. FLOODPLAIN MANAGEMENT

- Goddard, James E. "Floodplain Management Must be Ecologically and Economically Sound." *Civil Engineering* 41 (September 1971): 81-85.
- Howells, David H. "Urban Flood Management: Problems and Research Needs." *American Society of Civil Engineers Proceedings* 103 (WR 2 No. 13325) (November 1977): 193-212.
- Tettemer, John M. "County Flood Control District Utilizes Floodplain Management." *Public Works* 110 (July 1979): 71-3.

4. GENERAL RESOURCES

- Copp, Howard D. "Pullman Tackles Its Flooding Problem." *Civil Engineering* 42 (August 1972): pages 42-6.
- Grigg, Neil S. "Evaluation and Implementation of Urban Drainage Projects." *American Society of Civil Engineers Proceedings* 101 (UP 1 No. 11324) (May 1975): 61-75.
- James, L. Douglas. "Formulation of Nonstructural Flood Control Programs." *Water Resources Bulletin* 11 (August 1975): 688-705.
- Morris, William T. "Repositioned Equipment, Rigid Maintenance Program Ready Water Company for Next Hurricane" *Public Works* 107 (December 1967): 41-4.
- Rosenthal, Meyer. "Water Company Survival in the Major Flood." *Public Works*. 109 (May 1978): 64-5

- Amortization Period.** The length of time used to repay a debt or mortgage or to depreciate an initial cost.
- Amortization Rate.** The price or rate of premium per unit of time that is paid by a borrower for repayment of a debt or mortgage or by a purchaser to depreciate an initial cost.
- Backflow Preventer ('Check Valve').** A device that allows liquids to flow in only one direction in a pipe. Backflow preventers are used on sewer pipes to prevent a reverse flow during flooding situations.
- Backwater Effect.** The rise in water surface elevation caused by some obstruction such as a narrow bridge opening, buildings or fill material that limits the area through which the water must flow. Also referred to as 'heading up.'
- Base Flood.** A term used in the National Flood Insurance Program to indicate the minimum size flood to be used by a community as a basis for its floodplain management regulations; presently required by regulation to be that flood which has a one-percent chance of being equaled or exceeded in any given year. Also known as a 100-year flood or one-percent chance flood.
- Base Flood Elevation (BFE).** The elevation for which there is a one-percent chance in any given year that flood levels will equal or exceed it. The BFE is generally based on statistical analysis of stream flow records for the watershed and rainfall and runoff characteristics in the general region of the watershed, and application of hydraulic backwater models.
- Base Floodplain.** The floodplain that would be inundated by a one-percent chance (100-year) flood.
- Basin.** The total area from which surface runoff is carried away by a drainage system. Other comparable terms are 'drainage area,' 'catchment area,' and 'watershed.'
- Building.** See 'structure.'
- Building Code.** The regulations adopted by a local governing body setting forth standards for the construction, addition, modification and repair of buildings and other structures for the purpose of protecting the health, safety, and general welfare of the public.
- C.F.S.** Cubic feet per second. Used to describe the amount of flow passing a given point in a stream channel. One cubic foot per second is equivalent to approximately 7.5 gallons per second.
- Channel.** A natural or artificial watercourse with definite bed and banks to confine and conduct flowing water.
- Channel Capacity.** The maximum flow which can pass through a channel without overflowing the banks.
- Check Valve.** See 'backflow preventer.'
- Community.** Any state or area or political subdivision thereof, or any Indian tribe or authorized tribal organization which has the authority to adopt and enforce floodplain management regulations for the areas within its jurisdiction.
- Cross Section.** A graph or plot of ground elevation across a stream/valley or a portion of it, usually along a line perpendicular to the stream or direction of flow.
- Degree of Protection.** See 'level of protection.'
- Designated Floodway.** The channel of a stream and that portion of the adjoining floodplain designated by a regulatory agency to be kept free of further development to provide for unobstructed passage of flood flows.
- Design Flood.** Commonly used to mean the magnitude of flood used for design and operation of flood control structures or other protective measures. It is sometimes used to denote the magnitude of flood used in floodplain regulations.

Emergency Program. The phase of the National Flood Insurance Program which a community enters prior to the completion of an individual community flood insurance study. It is intended to provide a first layer amount of insurance at federally-subsidized rates on all existing structures and new construction begun prior to the effective date of a Flood Insurance Rate Map, in return for the community's adoption of general floodplain management regulations. See also 'National Flood Insurance Program.'

Enabling Statute. A State law that transfers some of the police power residing in the State to localities within it for the purposes of zoning, subdivision, regulations, building codes, and the like.

Encroachment. Any physical object placed in a floodplain that hinders the passage of water or otherwise affects flood flows, e.g. landfills, buildings.

Erosion. The wearing away of the land surface by running water, wind, ice, or other geological agents.

Existing Construction. As used in reference to the National Flood Insurance Program, any structure already existing or on which construction or substantial improvement was started prior to the effective date of a community's floodplain management regulations.

Flash Flood. A flood that reaches its peak flow in a short length of time (hours or minutes) after the storm or other event causing it. Often characterized by high velocity flows.

Flood or Flooding. Temporary inundation of normally dry land areas from the overflow of inland or tidal waters, or from the unusual and rapid accumulation or runoff of surface waters from any source. The rise in water may be caused by excessive rainfall, snowmelt, natural stream blockages, wind storms over a lake or any combination of such conditions.

Flood Control. Keeping flood waters away from specific developments or populated areas by the construction of flood storage reservoirs, channel alterations, dikes and levees, bypass channels, or other engineering works.

Flood Crest. The maximum stage or elevation reached or expected to be reached by the waters of a specific flood at a given location.

Flood Duration. The length of time a stream is above flood stage or overflowing its banks.

Flood Fighting. Actions taken immediately before or during a flood to protect human life and to reduce flood damages such as evacuation, emergency sandbagging and diking, and provision of assistance to flood victims.

Flood Forecasting. The process of predicting the occurrence, magnitude and duration of an imminent flood through meteorological and hydrological observations and analysis.

Flood Frequency. A statistical expression of the average time period between floods equaling or exceeding a given magnitude. For example, a 100-year flood has a magnitude expected to be equaled or exceeded on the average of once every hundred years; such a flood has a one-percent chance of being equaled or exceeded in any given year. Often used interchangeably with 'recurrence interval.'

Flood Fringe. The portion of the floodplain outside of the floodway but still subject to flooding. Sometimes referred to as 'floodway fringe.'

Flood Hazard Boundary Map (FHBM). An official map of a community, issued or approved by the Federal Emergency Management Agency, Federal Insurance Administration, on which the boundaries of the floodplain and special flood hazard areas have been designated. This map is prepared according to the best flood data available at the time of its preparation, and is superseded by the Flood Insurance Rate Map after more detailed studies have been completed.

Flood Insurance Rate Map (FIRM). An official map of a community issued or approved by the Federal Emergency Management Agency, Federal Insurance Administration, that delineates both the special hazard areas and the risk premium zones applicable to the community.

Flood Insurance Rate Zone. A zone identified on a Flood Insurance Rate Map (FIRM) as subject to a specified degree of flood, mudslide (i.e., mudflow) or flood-related erosion hazards, to which a particular set of actuarial rates and floodplain management requirement applies.

Flood Insurance Study (FIS). A study, funded by the Federal Emergency Management Agency, Federal Insurance Administration, and carried out by any of a variety of agencies and consultants, to delineate the special flood hazard areas, base flood elevations, and NFIP actuarial insurance rate zones. The study is based on detailed site surveys and analysis of site-specific hydrologic characteristics.

Floodplain. Any normally dry land area that is susceptible to being inundated by water from any natural source. This area is usually low land adjacent to a river, stream, watercourse, ocean or lake.

Floodplain Management. The operation of a program of corrective and preventive measures for reducing flood damage, including but not limited to flood control projects, floodplain land use regulations, floodproofing of buildings, and emergency preparedness plans.

Floodplain Regulations. General term applied to the full range of codes, ordinances and other regulations relating to the use of land and construction within floodplain limits. The term encompasses zoning ordinances, subdivision regulations, building and housing codes, encroachment laws and open area (space) regulations.

Flood Profile. A graph showing the relationship of water surface elevation to a specific location, the latter generally expressed as distance above the mouth of a stream of water flowing in an open channel. It is generally drawn to show surface elevation for the crest of a specific magnitude of flooding, but may be prepared for conditions at any given time or stage.

Floodproofing. Any combination of structural and nonstructural additions, changes, or adjustments to properties and structures which reduce or eliminate flood damage to lands, water and sanitary facilities, structures, and contents of buildings.

Floodway. The channel of a watercourse and those portions of the adjoining floodplain required to provide for the passage of the selected flood (normally the 100-year flood) with an insignificant increase in the flood levels above that of natural conditions. As used in the National Flood Insurance Program, floodways must be large enough to pass the 100-year flood without causing an increase in elevation of more than a specified amount (one foot in most areas).

Flood Warning. The issuance and dissemination of information about an imminent or current flood.

Freeboard. A factor of safety expressed in feet above a design flood level for flood protective or control works. Freeboard is intended to allow for all of the uncertainties in analysis, design and construction which cannot be fully or readily considered in an analytical fashion.

Groundwater Recharge. The infiltration of water into the earth. It may increase the total amount of water stored underground or only replenish supplied depleted through pumping or natural discharge.

Hazard Adjustment. See "structural" and "nonstructural floodplain management measures."

Hydrodynamic Loads. Forces imposed on structures by floodwaters due to the impact of moving water on the upstream side of the structure, drag along its sides, and eddies or negative pressures on its downstream side.

Hydrograph. A graph that charts the passage of water as a function of time. It shows flood stages, depicted in feet above mean sea level or gage height, plotted against stated time intervals.

Hydrology. The science of the behavior of water in the atmosphere, on the earth's surface, and underground.

Hydrostatic Loads. Those loads or pressures resulting from the static mass of water at any point of floodwater contact with a structure. They are equal in all directions and always act perpendicular to the surface on which they are applied. Hydrostatic loads can act vertically on structural members such as floors, decks, and roofs, and can act laterally on upright structural members such as walls, piers, and foundations.

Impact Loads. Loads induced by the collision of solid objects on a structure carried by floodwater.

Debris can include trees, lumber, displaced sections of structures, tanks, runaway boats, and chunks of ice. Debris impact loads are difficult to predict accurately, yet reasonable allowances must be made for them in the design of potentially affected structures.

Infiltration. The flow of fluid into a substance through pores or small openings. The word is commonly used to denote the flow of water into soil.

Level of Protection. The greatest flood level against which a protective measure is designed to be fully effective; often expressed as a recurrence interval (e.g., 100-year level of protection) or as an exceedance frequency (e.g., one-percent chance of exceedance).

Lowest Floor. Under the NFIP, this term means the lowest floor of the lowest enclosed area (including basement). The lowest floor is required to be placed at or above the Base Flood Elevation if elevated foundation construction techniques are employed. Exception: An unfinished or flood resistant enclosure, useable solely for parking of vehicles, building access or limited storage would not be considered a building's lowest floor if the enclosure met all applicable floodplain management design and use requirements.

Mean Sea Level. The average height of the sea for all stages of the tide over a nineteen year period, usually determined from hourly height observations on an open coast or in adjacent waters having free access to the sea.

National Flood Insurance Program (NFIP). The program under which communities may be eligible for federal flood insurance on the condition that the communities enact satisfactory floodplain management regulations.

New Construction. As used in reference to the National Flood Insurance Program, any structures on which construction or substantial improvement was started on or after the effective date of a community's floodplain management regulations.

Nonstructural Floodplain Management Measures.

Those measures employed to modify the exposure of buildings to floods, e.g. floodproofing, land use planning, warning schemes, and insurance, as opposed to structural measures such as dams, levees, and channel modifications.

Non-Velocity Coastal Flood Area. Any area that is subject to inundation by tidal waters which has lower velocity or wave components than a Coastal High Hazard Area.

One-Hundred Year Flood. A flood having a one-percent chance of being equalled or exceeded in any given year.

Permeability. The property of soil or rock that allows passage of water through it.

Primary Cost. The cost of providing the basic floodproofing feature -- elevation, flood shield, floodwall or levee.

Probable Maximum Flood. The most severe flood that may be expected from a combination of the most critical meteorological and hydrological conditions that are reasonably possible in the drainage basin. It is used in designing high-risk flood protection works and siting of structures and facilities that must be subject to almost no risk of flooding. The probable maximum flood is usually much larger than the 100-year flood.

Profile. A graph or plot of the water surface elevation against distance along a channel. Also termed 'flood profile' if drawn for a specific flood or level of flooding.

Recurrence Interval. A statistical expression of the average time between floods equalling or exceeding a given magnitude (see flood frequency).

Regulatory Flood Datum (RFD). Established plane of reference from which elevation and depth of flooding may be determined for specific locations of the floodplain. It is the Base Flood plus a freeboard factor of safety established for each particular area which tends to compensate for the many unknown and uncalculable factors that could contribute to greater flood heights than that computed for a Base Flood.

- Regulatory Floodplain.** That portion of the floodplain subject to floodplain regulations (usually the floodplain inundated by the one-percent chance flood).
- Regulatory Floodway.** The channel and that portion of the adjacent land area that is required through regulations to pass flood flows without increasing the water surface elevation more than a designated height.
- Regular Program.** The phase of the National Flood Insurance Program that makes available increased amounts of flood insurance, with new and substantially improved structures being rated on an actuarial or actual risk basis.
- Reservoir.** A natural or artificially created pond, lake or other space used for storage, regulation or control of water. May be either permanent or temporary.
- Riverine.** Relating to, formed by, or resembling a river (including tributaries), stream, brook, etc.
- Runoff.** That portion of precipitation which is not intercepted by vegetation, absorbed by the land surface or evaporated, and thus flows overland into a depression, stream, lake or ocean (runoff called "immediate subsurface runoff" also takes place in the upper layers of the soil).
- Secondary Cost.** The cost associated with floodproofing activities, other than providing the basic floodproofing features, that are necessary to prevent a structure from being damaged by flooding.
- Seepage.** The passage of water or other fluid through a porous medium, such as the passage of water through an earth embankment or masonry wall.
- Special Flood Hazard Areas.** Areas in a community that have been identified as susceptible to a one-percent or greater chance of flooding in any given year. A one-percent-probability flood is also known as the 100-year flood or the base flood. Special Flood Hazard Areas are usually designated on the Flood Hazard Boundary Map (FHBM) as Zone A. After detailed evaluation of local flooding characteristics, the Flood Insurance Rate Map (FIRM) will refine this categorization into Zones A, AE, AH, AO, A1-30, VE, and V1-30.
- Standard Project Flood.** A term used by the U.S. Army Corps of Engineers to designate a flood that may be expected from the most severe combination of meteorological and hydrological conditions that is considered reasonably characteristic of the geographical area in which the drainage basin is located, excluding extremely rare combinations. The peak flow for a standard project flood is generally 40 to 60 percent of the probable maximum flood for the same location.
- State Coordinating Agency.** The agency of the state government designated by the Governor of the state at the request of the Administrator to coordinate the flood insurance program in that state.
- Stream.** A body of water flowing in a natural surface channel. Flow may be continuous or only during wet periods. Streams which flow only during wet periods are termed "intermittent streams."
- Structural Floodplain Management Measures.** Those physical or engineering measures employed to modify the way floods behave, e.g., dams, dikes, levees, channel enlargements and diversions.
- Structure.** A walled and roofed building, including a gas or liquid storage tank, that is principally above ground and affixed to a permanent site, as well as a mobile home on foundation.
- Subdivision Regulations.** Ordinances or regulations governing the subdivision of land with respect to such things as adequacy and suitability of building sites, utilities and public facilities.
- Subsidence.** Sinking of the land surface, usually due to withdrawals of underground water, oil, or minerals.
- Subsidized Rates.** The rates which involve subsidizations by the Federal Government to encourage the purchase of flood insurance on existing structures at reasonably affordable costs.

Substantial Improvement. A term used in connection with the National Flood Insurance Program for determining when its regulations must be applied to actions involving existing structures. It means any repair, reconstruction, or improvement of a structure, the cost of which equals or exceeds 50 percent of the market value of the structure either: (a) before the improvement or repair is started; or (b) if the structure has been damaged, and is being restored, before the damage occurred. The term does not, however, include either (1) any project for improvement of a structure to comply with existing state or local health sanitary, or safety code specifications which are solely necessary to assure safe living conditions or (2) any alteration of a structure listed on the National Register of Historic Places or a State Inventory of Historic Places.

Underseepage. Seepage along the bottom of a structure, floodwall, or levee or through the layer of earth beneath it.

Variance. A grant of relief by a community to a person from the terms of a floodplain management regulation permitting construction in a manner otherwise prohibited by the regulation and where specific enforcement would result in unnecessary hardship. Specific requirements may vary depending on state zoning enabling legislation or community ordinances.

Watercourse. A natural or artificial channel in which a flow of water occurs either continually or intermittently.

Watershed. An area from which water drains to a single point; in a natural basin, the watershed is the area contributing flow to a given place or a given point on a stream.

Water Surface Elevation. The heights, usually in relation to mean sea level, reached by flows of various magnitudes and frequencies at pertinent points in the floodplain.

Water Table. The uppermost zone of water saturation in the ground.

Wetlands. Areas that are inundated or saturated at a frequency and for a duration sufficient to support a prevalence of vegetative or aquatic life requiring saturated or seasonally saturated soil conditions for growth and reproduction.

Zoning Ordinance. An ordinance under the State or local government's police power which divides an area into districts and, within each district, regulates the use of land and buildings, height and bulk of buildings or other structures, and the density of population.

APPENDIX C SOURCES OF ASSISTANCE

FEDERAL EMERGENCY MANAGEMENT AGENCY (FEMA)

Types of Assistance:

- National Flood Insurance Program
- Flood Hazard Boundary Maps and Flood Insurance Rate Maps
- Seminars for building inspectors and other municipal officials
- Planning assistance for developing local regulations to meet the program's floodplain management requirements
- Engineering assistance on structure location and construction
- Flood map evaluations and appeals
- Information on flood characteristics

Contact Offices:

Region I:

Connecticut, Maine, Massachusetts, New Hampshire, Rhode Island, and Vermont

J.W. McCormack
Post Office & Courthouse Building
Room 442
Boston, Massachusetts 02109
(617) 223-4741

Region II:

New Jersey, New York, Puerto Rico and Virgin Islands

26 Federal Plaza Room 1337
New York, New York 10278
(212) 264-8980

Region III:

Delaware, District of Columbia, Maryland, Pennsylvania, Virginia, and West Virginia

Liberty Square Building
(Second Floor)
105 South Seventh Street
Philadelphia, Pennsylvania 19106
(215) 597-9416

Region IV:

Alabama, Florida, Georgia, Kentucky, Mississippi, North Carolina, South Carolina, and Tennessee

Gulf Oil Building,
Suite 700
1371 Peachtree Street, N.E.
Atlanta, Georgia 30309
(404) 347-2391

Region V:

Illinois, Indiana, Michigan, Minnesota, Ohio and Wisconsin

300 S. Wacker Drive - 24th Floor
Chicago, Illinois 60606
(312) 353-8661

Region VI:

Arkansas, Louisiana, New Mexico, Oklahoma and Texas

Federal Regional Center
800 N. Loop, 288
Denton, Texas 76201-3698
(817) 387-5811

Region VII:

Iowa, Kansas, Missouri and Nebraska
911 Walnut Street, Room 300
Kansas City, Missouri 64106
(816) 374-5912



Region VIII:

Colorado, Montana, North Dakota, South Dakota,
Utah and Wyoming

Federal Regional Center
Building 710, Box 25267
Denver, Colorado 80225-0267
(303) 235-4811

Region IX:

Arizona, California, Hawaii, and Nevada

Building 105
Presidio of San Francisco, California 94129
(415) 556-8794

Region X:

Alaska, Idaho, Oregon, and Washington

Federal Regional Center
130 228th Street, Southwest
Bothell, Washington 98021-9796
(206) 481-8800

U.S. ARMY CORPS OF ENGINEERS (COE)**Types of Assistance:**

- Floodplain delineation.
- Technical assistance on individual sites on flood depth, velocity, flood frequency, and duration.
- Structural information on floodwalls and levees.
- Assistance during flooding with materials, equipment and personnel.
- Post flooding assistance for the rehabilitation of damaged public facilities and protective works.

Division Offices:

North Atlantic Division
90 Church Street
New York, NY 10007
212/264-7483

South Atlantic Division
510 Title Bldg.
30 Pryor Street S. W.
Atlanta, GA 30303
404/221-6702

Southwestern Division
Main Tower Bldg.
1114 Commerce St.
Dallas, Texas 75242
214/767-2310

South Pacific Division
630 Sansom Street
Room 1216
San Francisco, CA 94111

Lower Mississippi Valley
1400 Walnut Street
Vicksburg, MS 39180
601/634-5843, Ext. 385

Missouri River Division
12565 W. Center Road
Omaha, NE 68101
402/221-7270

North Central Division
536 S. Clark Street
Chicago, Illinois 60605
312/353-6531

Ohio River Division
550 Main Street
Cincinnati, Ohio 45201
513/684-3012

North Pacific Division
220 N.W. 8th Avenue
Portland, OR 97208
503/221-3823

New England Division
424 Trapelo Road
Waltham, MA 02154
617/894-2400, Ext. 545

Pacific Ocean Division
Bldg. 230
Fort Shafter, HI 96858
808/438-2883

U.S. Army Corps of Engineers (COE) continued

District Office Locations:

Flood Plain Management Services Program representatives in each of the following Corps District offices can provide additional information concerning flood proofing techniques.

Office, Chief of Engineers
Department of the Army
Washington, DC 20314

Lower Mississippi Valley Division

U.S. Army Engineer District, Memphis
8314 Clifford Davis Federal Building
Memphis, TN 38103

U.S. Army Engineer District, New Orleans
P.O. Box 60267
New Orleans, LA 70160

U.S. Army Engineer District, St. Louis
210 Tucker Blvd. N.
St. Louis, MO 63101

U.S. Army Engineer District, Vicksburg
P.O. Box 60
Vicksburg, MS 39180

Missouri River Division

U.S. Army Engineer District, Kansas City
700 Federal Building
601 E. 12th Street
Kansas City, MO 64106

U.S. Army Engineer District, Omaha
6014 USPO and Courthouse
Omaha, NE 68102

North Atlantic Division

U.S. Army Engineer District, Baltimore
P.O. Box 1715
Baltimore, MD 21203

U.S. Army Engineer District, New York
26 Federal Plaza
New York, NY 10278

U.S. Army Engineer District, Norfolk
803 Front Street
Norfolk, VA 23510

U.S. Army Engineer District, Philadelphia
U.S. Custom House
2nd and Chestnut Streets
Philadelphia, PA 19106

North Central Division

U.S. Army Engineer District, Buffalo
1776 Niagara Street
Buffalo, NY 14207

U.S. Army Engineer District, Chicago
219 S. Dearborn Street
Chicago, IL 60604

U.S. Army Engineer District, Detroit
P.O. Box 1027
Detroit, MI 48231

U.S. Army Engineer District, Rock Island
Clock Tower Building
Rock Island, IL 61201

U.S. Army Engineer District, St. Paul
1135 USPO and Customhouse
St. Paul, MN 55101

North Pacific Division

U.S. Army Engineer District, Alaska
Pouch 878
Anchorage, AK 99506

U.S. Army Engineer District, Portland
P.O. Box 2946
Portland, OR 97208

U.S. Army Engineer District, Seattle
P.O. Box C-3755
Seattle, WA 98124

U.S. Army Engineer District, Walla Walla
Building 602, City-County Airport
Walla Walla, WA 99362

Ohio River Division

U.S. Army Engineer District, Huntington
502 8th Street
Huntington, WV 25701

U.S. Army Engineer District, Louisville
P.O. Box 59
Louisville, KY 40201

U.S. Army Engineer District, Nashville
P.O. Box 1070
Nashville, TN 37202

U.S. Army Engineer District, Pittsburg
William S. Moorhead Federal Building
1000 Liberty Avenue
Pittsburg, PA 15222

South Atlantic Division

U.S. Army Engineer District, Charleston
P.O. Box 919
Charleston, SC 29402

U.S. Army Engineer District, Jacksonville
P.O. Box 4970
Jacksonville, FL 32232

U.S. Army Engineer District, Mobile
P.O. Box 2288
Mobile, AL 36628

U.S. Army Engineer District, Savannah
P.O. Box 889
Savannah, GA 31402

U.S. Army Engineer District, Wilmington
P.O. Box 1890
Wilmington, NC 28402

South Pacific Division

U.S. Army Engineer District, Los Angeles
P.O. Box 2711
Los Angeles, CA 90053

U.S. Army Engineer District, Sacramento
650 Capital Mall
Sacramento, CA 95814

U.S. Army Engineer District, San Francisco
211 Main Street
San Francisco, CA 94105

Southwestern Division

U.S. Army Engineer District, Albuquerque
P.O. Box 1580
Albuquerque, NM 87103

U.S. Army Engineer District, Fort Worth
P.O. Box 17300
Fort Worth, TX 76102

U.S. Army Engineer District, Galveston
P.O. Box 1229
Galveston, TX 77553

U.S. Army Engineer District, Little Rock
P.O. Box 867
Little Rock, AR 72203

U.S. Army Engineer District, Tulsa
P.O. Box 61
Tulsa, OK 74121

U.S. Army Engineer District, Huntsville
P.O. Box 1600, West Station
Huntsville, AL 35806

SOIL CONSERVATION SERVICE (SCS)

Types of Assistance:

- Floodplain delineation and characteristics
- Engineering and technical assistance
- Planning assistance and public information
- Post-flood relief
- Flood warning systems and preparedness

Contact Offices:

Information can be obtained from the SCS state office or county office. Consult your local telephone directory under U.S. Government, Department of Agriculture.



**UNITED STATES GEOLOGICAL SURVEY
(U.S.G.S.)**

Types of Assistance:

- River level and discharge records
- Floodplain information

Contact Office:

The United States Geological Survey has an office in every state. Contact with these offices can be made through the Geology Department of your closest state university.

**DEPARTMENT OF COMMERCE, NATIONAL
OCEANIC AND ATMOSPHERIC
ADMINISTRATION (NOAA)**

Type of Assistance:

- Historic weather records
- Hydrologic data
- Flood warning assistance
- Public Information
- Storm surge data

Contact Offices:

National Oceanic & Atmospheric Administration
Eastern Region, National Weather Service
585 Stewart Avenue
Garden City, New York 11530
(516)/222-1616

National Oceanic & Atmospheric Administration
Southern Region, National Weather Service
819 Taylor Street
Rm. 10E09
Fort Worth, Texas 76102
(817)/334-2668

National Oceanic & Atmospheric Administration
Central Region, National Weather Service
601 E. 12th Street
Rm. 1836
Kansas City, MO 64106
(815)/374-5463

National Oceanic & Atmospheric Administration
Western Region, National Weather Service
Box 11188 Federal Bldg.
125 S. State Street
Salt Lake City, UT 84147
(801)/524-5122

National Oceanic & Atmospheric Administration
Alaskan Region, National Weather Service
Box 23, 701 C. Street
Anchorage, AL 99513
(907)/271-5116

National Oceanic & Atmospheric Administration
Pacific Region, National Weather Service
Prince Kuhio Federal Bldg, Room 4110
Box 50027
300 Ala Moana Blvd.
Honolulu, Hawaii 96850
(808)/546-5680

REGIONAL AUTHORITIES

Types of Assistance

There are several regional authorities which provide technical assistance in areas related to floodproofing such as

- Floodwater control method designs and evaluations
- Technical assistance
- Flood characteristics
- Floodplain regulations
- Dissemination of public information
- Post-flood disaster relief assistance.

INTERSTATE COMPACT COMMISSIONS

Delaware River Basin Commission
P. O. Box 7630
West Trenton, NJ 08628
(609) 883-9500

Susquehanna River Basin Commission
1721 North Front Street
Harrisburg, PA 17102
(717) 238-0423

TENNESSEE VALLEY AUTHORITY

Tennessee Valley Authority
Flood Plain Management Branch 190
Liberty Building Knoxville, TN 37902
(615) 632-4451

STATE CONTACTS FOR THE NATIONAL FLOOD INSURANCE PROGRAM

Types of Assistance:

- NFIP information
- Floodplain regulations
- Floodplain management information

Contact Office:

The following is a list of state office contacts for the National Flood Insurance Program:

Alabama

Department of Economic & Community Affairs
State Capitol Building
P.O. 2939
3465 Norman Bridge Road
Montgomery, Alabama 36105-0939
(205) 284-8735

Alaska

Department of Community & Regional Affairs
Municipal & Regional Assistance Division
949 East 36 Avenue, Suite 400
Anchorage, Alaska 99508
(907) 561-8586

Arizona

Department of Water Resources
Flood Control Branch
99 East Virginia, 2nd Floor
Phoenix, Arizona 85004
(602) 255-1566

Arkansas

Arkansas Soil & Water Conservation Commission
#1 Capitol Mall - Suite 2D
Little Rock, Arkansas 72201
(501) 371-1611

California

Department of Water Resources
P.O. Box 388
Sacramento, California 95802
(916) 445-6249

Colorado

Colorado Water Conservation Board
State Centennial Bldg., Room 823
1313 Sherman Street
Denver, Colorado 80203
(303) 866-3441

Connecticut

State Dept. of Environmental Protection
Water Resources Unit
165 Capitol Avenue
Hartford, Connecticut 06106
(203) 566-7245

Delaware

Dept. of Natural Resources & Environmental
Control
Division of Soil & Water Conservation
Richardson & Robbins Building
89 Kings Highway - P.O. 1401
Dover, Delaware 19903
(302) 736-4411

District of Columbia

Department of Consumer Regulatory Affairs
614 H. St., N.W.
Washington, D.C. 20001
(202) 727-7577

Florida

Department of Community Affairs
Division of Resource Planning and Management
2571 Executive Ctr. Circle
East Tallahassee, Florida 32301
(904) 488-8466

Georgia

Department of Natural Resources
19 Martin Luther King, Jr. Drive, S.W.
Room 400
Atlanta, Georgia 30334
(404) 656-3214

Guam

Director, Office of Civil Defense
P.O. Box 2877
Agana, Guam 96910
011-671-477-9841

Hawaii

Hawaii Board of Land & Natural Resources
P.O. Box 373
Honolulu, Hawaii 96809
(808) 548-7539

Idaho

Department of Water Resources
State House
Boise, Idaho 83720
(208) 334-4470

Illinois

Illinois Dept. of Transportation
Division of Water Resources
Local Floodplain Programs
300 North State Street, Room 1010
Chicago, Illinois 60610
(312) 793-3864

Indiana

Department of Natural Resources
608 State Office Building
Indianapolis, Indiana 46204
(317) 232-4160

Iowa

Iowa Dept. of Water, Air and Waste Management
Wallace State Office Building
Des Moines, Iowa 50319
(515) 281-5029

Kansas

Kansas State Board of Agriculture
Division of Water Resources
109 Southwest Ninth Street
Topeka, Kansas 66612-1283
(913) 296-3717

Kentucky

Department of Natural Resources
Division of Water
18 Reilly Road
Fort Boone Plaza
Frankfort, Kentucky 40601
(502) 564-3410

Louisiana

Louisiana Dept. of Urban & Community Affairs
P.O. Box 44455 - Capitol Station
Baton Rouge, Louisiana 70804
(504) 925-1730

Maine

Bureau of Civil Emergency Preparedness
State House
187 State Street
Augusta, Maine 04330
(207) 289-3154

Maryland

Maryland Water Resources Administration
Tawes State Office Building D-2
Annapolis, Maryland 21401
(301) 269-3826

Massachusetts

Massachusetts Water Resources Commission
State Office Building
100 Cambridge Street
Boston, Massachusetts 02202
(617) 727-3267

Michigan

Water Management Division
Michigan Department of Natural Resources
P.O. Box 30028
Lansing, Michigan 48909
(517) 373-3930

Minnesota

Department of Natural Resources
Floodplains/Shoreline Management Section
Division of Waters
444 LaFayette Road
St. Paul, Minnesota 55101
(612) 296-9226

Mississippi

Mississippi Research & Development Center
3825 Ridgewood Road
Jackson, Mississippi 39211
(601) 982-6376

Missouri

Department of Natural Resources
1101 R. Southwest Boulevard
P.O. Box 1368
Jefferson City, Missouri 65102
(314) 751-4932

Montana

Montana Department of Natural Resources &
Conservation
Engineering Bureau
32 South Ewing Street
Helena, Montana 59601
(406) 444-6646

Nebraska

Nebraska Natural Resources Commission
P.O. Box 94876
Lincoln, Nebraska 68509
(402) 471-2081

Nevada

Division of Emergency Management
Capitol Complex
Carson City, Nevada 89710
(702) 885-4240

New Hampshire

New Hampshire Office of State Planning
2 1/2 Beacon Street
Concord, New Hampshire 03301
(603) 271-2231

New Jersey

New Jersey Dept. of Environmental Protection
Division of Water Resources
P.O. Box CN 029
Trenton, New Jersey 08625
(609) 292-2296

New Mexico

State Engineer's Office
Rataan Memorial Building
Santa Fe, New Mexico 97501
(505) 827-6140

New York

Department of Environmental Conservation
Flood Protection Bureau
50 Wolf Road, Room 422
Albany, New York 12213
(518) 457-3157

North Carolina

North Carolina Dept. of Natural Resources and
Community Development
Division of Community Assistance
512 North Salisbury Street
P.O. Box 27687
Raleigh, North Carolina 27611
(919) 733-2850

North Dakota

State Water Commission
900 East Boulevard
Bismarck, North Dakota 58505
(791)224-2750

Ohio

Ohio Dept. of Natural Resources
Floodplain Planning Unit
Fountain Square
Columbus, Ohio 43224
(614) 265-6755

Oklahoma

Oklahoma Water Resources Board
12th Floor
Northeast 10th & Stonewall
Oklahoma City, Oklahoma 73105
(405) 271-2533

Oregon

Department of Land Conservation & Development
1175 Court Street, N.E.
Salem, Oregon 97310
(503) 378-2332

Pennsylvania

Department of Community Affairs
551 Forum Building
Harrisburg, Pennsylvania 17120
(717) 787-7400

Puerto Rico

Puerto Rico Planning Board
P.O. Box 41119, Minillas Station
D-Diego Avenue
Sanurce, Puerto Rico 00940
(809) 726-7110

Rhode Island

Office of State Planning
Statewide Planning Program
265 Melrose Street
Providence, Rhode Island 02907
(401) 277-2656

South Carolina

South Carolina Water Resources Commission
3830 Forest Drive
P.O. Box 4440
Columbia, South Carolina 29240
(803) 758-2514

South Dakota

Department of Military & Veteran Affairs
Division of Emergency and Disaster Services
State Capitol
Pierre, South Dakota 57501
(605) 773-3231

Tennessee

Department of Economic & Community
Development
Local Planning Division
1800 James K. Polk Office Building
505 Deaderick Street
Nashville, Tennessee 37219
(615) 741-2211

Texas

Texas Dept. of Water Resources
P.O. Box 13087, Capitol Station
1700 North Congress Avenue
Austin, Texas 78711
(512) 475-2171

Utah

Office of Comprehensive Emergency Management
1543 Sunnyside Avenue
Salt Lake City, Utah 84108
(801) 533-5271

Vermont

Agency of Environmental Conservation
Division of Water Resources
State Office Building
Montpelier, Vermont 05602
(802) 828-2761

Virgin Islands

Disaster Preparedness
Office Box 1208
St. Thomas, Virgin Islands 00801
(809) 774-6555

Virginia

Virginia State Water Control Board
P.O. Box 11143
2111 North Hamilton Street
Richmond, Virginia 23230
(804) 257-0075

Washington

Department of Ecology
Mail Stop PV11
Olympia, Washington 98504
(206) 459-6288

West Virginia

West Virginia Office of Emergency Services
Capitol Building
Room EB-80
Charleston, West Virginia 25305
(304) 348-3831

Wisconsin

Department of Natural Resources
Floodplain-Shoreland Management Section
P.O. Box 7921
Madison, Wisconsin 53707
(608) 266-1926

Wyoming

Wyoming Disaster & Civil Defense Agency
P.O. Box 1709
Cheyenne, Wyoming 82003
(307) 777-7566

LOCAL AGENCIES**Types of Assistance**

- Floodplain Maps
- Building, zoning, subdivision, ordinance to guide development in the floodplain
- Primary source of informing the public about projects
- Provide assistance and planning on interpretation of state and federal regulations.

Contact Offices:

These offices vary depending on jurisdictional boundaries of cities, counties, townships, etc.. Therefore, the manual user is directed to consult your local telephone directory under local Government for assistance.

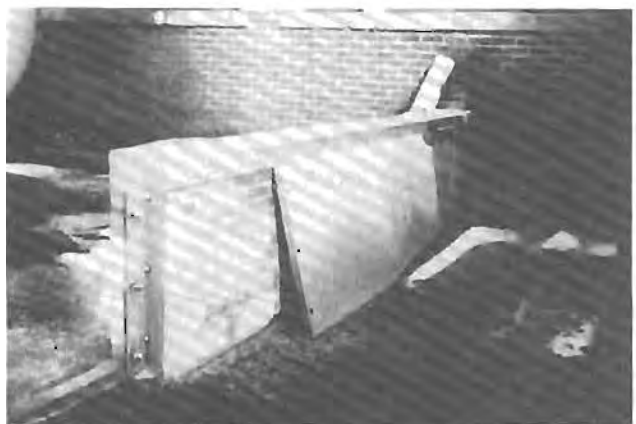

A. INTRODUCTION

This appendix presents concepts and criteria for the design and evaluation of floodproofing measures. The appendix begins with a discussion of the various forces, or structural loads, that must be understood to formulate preliminary floodproofing plans. Section C then presents criteria that describe the desired level of performance for various floodproofing methods. These performance criteria are applicable to all methods developed in Chapter III, which presents design guidelines for (1) elevated structures, (2) closures and flood shields, and (3) floodwalls and levees, and in Chapter IV, which describes emergency measures and utility protection.

Before proceeding with a presentation of design loads, it is desirable to acquaint the reader with the effects floodwater may have on a structure. This information provides some insight into the rationale that has been applied in the development and application of flood protection alternatives.

The *Flood Emergency and Residential Repair Handbook* (developed by the Federal Emergency Management Agency) identifies seven major effects of floodwater: hydrostatic pressure, buoyancy, battering, pulsating water, translation, scouring and overturning as shown on Figure D-1 and described below:

- **Hydrostatic Pressure.** Extreme pressure can be exerted on the walls of a building that is subjected to saturated soil and/or inundation. At a depth of 5 feet, water exerts over 300 pounds of pressure per square foot of surface. This pressure can result in major structural failure if certain combinations of adverse natural and structural factors are combined. Hydrostatic pressures may be alleviated by allowing waters to enter the structure.

- **Buoyancy/Uplift.** An object in water is buoyed by an upward force equal to the weight of the water displaced. Therefore, each cubic foot of water displaced by the structure exerts enough force to float about 62 pounds. The average 1-story house with basement could reach a buoyant condition and begin to float out of the ground when outside water has reached about 3 feet above the basement floor (assuming total soil saturation). Hydrostatic loads generally lead to basement floor or wall failure before a buoyant condition is reached. Effective anchoring systems can greatly improve a structure's resistance to buoyant forces. Although buoyancy is a concern for non-residential structures, use of heavier construction materials contributes to increased resistance to uplift forces.

- **Battering.** The battering force exerted by rushing water, waves, or floating objects in the water represent a major flood hazard in many areas. Battering forces can destroy any type of structure including masonry or concrete structures that have limited lateral strength. Reinforcing steel, used in conjunction with concrete wall structures, can greatly improve resistance to battering forces.



- **Pulsating Water.** Pulsating water action is most pronounced when it enters a structure. Water rushing in is stopped by an opposite wall and returned towards the point of entry. Furnishings and structural elements may be seriously damaged by these pulsating waters.
- **Translation.** Translation refers to the physical movement of a structure off its foundation by the forces exerted from flood waters. If forces exerted by the surrounding water are unevenly distributed, the structure may rotate. Buoyant forces may make a structure more vulnerable to translation. An effective sill anchoring system can protect against translation or lifting forces.
- **Scouring.** Scouring action may remove stabilizing soil and eventually undermine a structure. Scouring can be caused by high velocity and/or wave action. The affect is often amplified at the corners of the structure. Scouring at corners may be alleviated by soil stabilization, vegetation, or buried structural wing walls.
- **Overturning.** Rushing water or wave action can combine with buoyant forces or a bottom snagging effect to turn a structure onto its side.

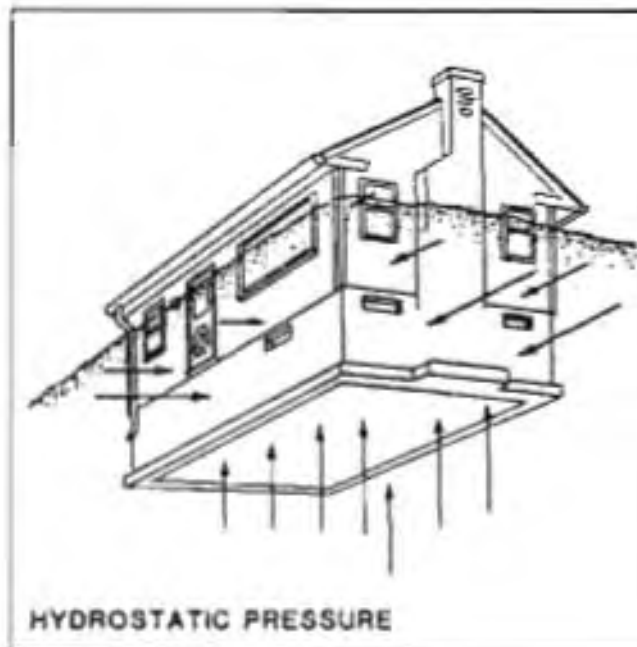

Figure D-1.
Effects of Floodwater
180



Figure D-1. (cont.)
Effects of Floodwater

B. DESIGN LOADS

Before describing the technical parameters of various floodproofing techniques, it is important that there is an understanding of the type and magnitude of forces to which a floodproofed structure may be subjected to. The *design load* for a structure may be defined as the minimum loading condition that the structure and all associated service systems should be designed to resist. Much of the following presentation on design loads has been based on guidance provided in *Flood-Proofing Regulations*, as published by the Corps of Engineers. For the purpose of this manual, calculation of design load will include the following factors:

1. DEAD LOAD (D). Dead load includes the weight of all permanent construction including: (a) the weight of the structure itself, (b) the weight of all permanent construction materials, (c) the weight of permanent equipment, and (d) forces resulting from prestressing.

2. GRAVITY LIVE LOAD (L). Gravity live loads result from both the occupancy (floor) and the environment (roof) of the building, as stipulated in the applicable building code.

3. RESTRAINT LOADS (R). Restraint loads result from expansion, contraction, creep, swelling and shrinkage of structural components; and forces associated with movement resulting from differential settlement.

4. WIND LOADS (W). The flowing wind exerts velocity pressures on a structure in its path. A horizontal pressure is usually assumed to act normal to the gross area of the vertical projection of the exposed or windward wall; and because wind flowing over and about a structure speeds up, it also tends to create a suction or outward pressure on the leeward wall and sidewalls. Likewise, an upward suction or uplift can be experienced by the roof system.

Basic wind design data and procedures to be followed in applying wind loadings to all structures are furnished in several building codes including the Southern Building Code Congress International Standard Building Code; the Building Officials and Code Administrators (BOCA) Code; and the Uniform Building Code. Each code employs a slightly different procedure for computation of the applied loads used in structural analysis and design; and each code contains explicit procedures for evaluating the magnitude and effect of applied wind pressures and how they should be combined in the sizing of various structural framing members and systems.

The recommended basic wind speed in a non-coastal or riverine flood site should be no less than the Annual Extreme Fastest-Mile Speed 30 feet above ground, 50-Year Mean Recurrence Interval, when combined with other flood loading forces. Obviously, the chances are remote that a higher mean recurrence interval would occur in combination with severe flooding situations. (Coastal floodplain situations are much more severe and the 100-year Mean Recurrence Interval is usually employed.)

5. FLOODWATER LOADS (F). Extreme pressure can be exerted on all surfaces of a structure that are exposed to flood waters. These pressures can result in cracking, displacement or collapse of walls, floors and horizontal framing members of a structure. With the exception of impact loads (see Item 6 below) flood water forces can be classified into hydrostatic and hydrodynamic loads. Sections 602.0 and 604.0 of the Corps of Engineers' publication *Flood-Proofing Regulations* are reproduced in part below to define these loads:

a) Water Loads

Water loads, defined herein, are loads or pressures on surfaces of the buildings and structures caused and induced by the presence of flood waters. These loads are of two basic types: hydrostatic and hydrodynamic.

1) Hydrostatic Loads: Hydrostatic loads are those caused by either free or contained water occurring above or below the ground surface. These loads are equal to the product of the water pressure times the surface area on which the pressure acts. The pressure at any point is equal to the product of the unit weight of water (62.5 pounds per cubic foot) multiplied by the height of water above the point or by the height to which confined water would rise if free to do so. Hydrostatic pressures at any point are equal in all directions and always act perpendicularly to the surface on which they are applied. Hydrostatic loads are subdivided into the following types:

- **Vertical Loads:** These are loads acting vertically downward on horizontal or inclined surfaces of buildings or structures, such as roofs, decks or floors, and walls, caused by the weight of flood waters above them.
- **Lateral Loads:** Lateral hydrostatic loads are those which act in a horizontal direction, against vertical or inclined surfaces, both above and below the ground surface and tend to cause lateral displacement and overturning of the building, structure, or parts thereof.
- **Uplift:** Uplift loads are those which act in a vertically upward direction on the underside of horizontal or sloping surfaces of buildings or structures, such as basement slabs, footings, floors, decks, roofs and overhangs.

2) Hydrodynamic Loads: Hydrodynamic loads are those induced on buildings or structures by the flow of floodwater around the building or structure or parts thereof, above ground level. Such loads may occur below the ground level when openings or conduits exist that allow free flow of floodwaters. Hydrodynamic loads are basically of the lateral type and relate to direct impact loads by the moving mass of water, and to drag forces as the water flows around the obstruction. (Where application of hydrodynamic loads is required, the loads should be computed or estimated by recognized and authoritative methods.)

- **Conversion to Equivalent Hydrostatic Loads:** ... for cases when water velocities do not exceed 10 feet per second, dynamic effects of the moving water may be converted into equivalent hydrostatic loads by increasing the depth of water to the Design Flood level) by an amount dh , (Figure D-2), on the headwater side and above the ground level only, equal to:

$$dh = aV^2/2g, \text{ where}$$

V is the average velocity of the water in feet per second; (fps);

g is the acceleration of gravity (32.2 fps);

a is the coefficient of drag or shape factor. (The value of a , unless otherwise evaluated, shall not be less than 1.25).

The equivalent surcharge depth dh is added to the depth (at the Design Flood Level)... and the resultant pressures applied to, and uniformly distributed across, the vertical projected area of the building or structure which is perpendicular to the flow. Surfaces parallel to the flow or downstream surfaces should be considered subject to hydrostatic pressures for depths to the (Design Flood level) only.

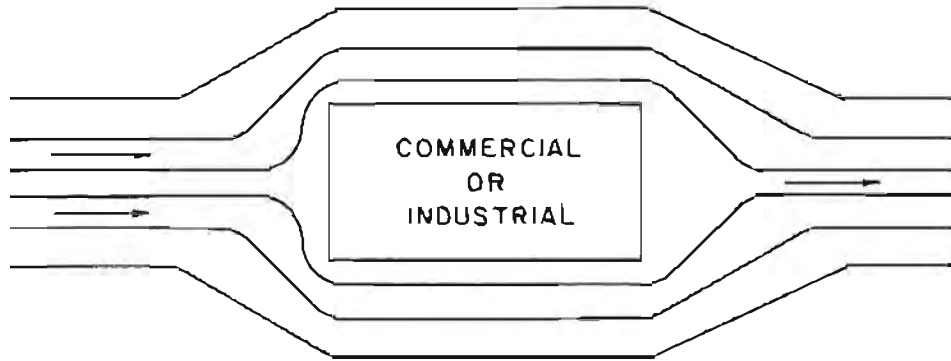

PLAN

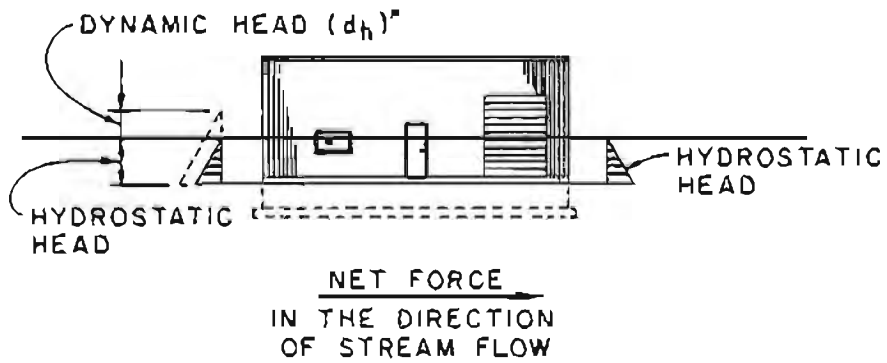

ELEVATION

FIGURE D-2
DYNAMIC EFFECTS OF MOVING WATER

• EXAMPLE: FOR FLOODWATER VELOCITY 8FPS. $d_h = (1.25 \times 8^3) \div 2 \times 32.2 = 1.24$ feet

b) **Intensity of Loads:** The application of the loads defined above should be made in the design calculations in the manner described as follows:

- **Vertical Loads:** Full intensity of hydrostatic pressures caused by a depth of water (at the Design Flood level) applied on all surfaces involved.
- **Lateral Loads:** Full intensity of hydrostatic pressures caused by a depth of water (at the Design Flood level) applied over all surfaces involved, both above and below ground level, except that for surfaces exposed to free water, the design depth should be increased by one foot.
- **Uplift:** Full intensity of hydrostatic pressures caused by a depth of water (at the Design Flood level) acting on all surfaces involved, unless provisions are made to reduce uplift intensities.

Hydrostatic loads should be used in the design of buildings and structures exposed to water loads from stagnant floodwaters. For buildings and structures, or parts thereof, that are exposed and subject to flowing water having velocities greater than five (5) feet per second, hydrostatic and hydrodynamic loads shall apply.

c) **Reduction of Uplift Pressures:** Uplift forces, in conjunction with lateral hydrostatic forces, constitute the most adverse flood related loading on buildings and structures and elements thereof. Their combined effect determines to a major extent the requirements for weight and anchorage of a structure as a whole to assure its stability against flotation, sliding, and overturning. When uplift forces are applied to structural elements of a building or structure, such as footings, walls, and particularly basement slabs, they generally constitute the critical loading on such elements. Economical solutions to flood-proofing buildings and structures may be aided by the use of impervious cutoffs, foundation drainage, and sumps and pumps.

6. **FLOOD IMPACT LOADS (FI).** Flood impact loads are imposed on a structure by solid objects that are propelled by moving floodwaters. Although it is difficult to predict the exact magnitude of probable impact loads, representative values must be included in the design of floodproofed buildings and structures. Impact loads are defined in Section 603.0 and 605.0 of *Flood-Proofing Regulations* as described below:

a) **Impact Loads:** Impact loads are those which result from floating debris, ice and any floatable object or mass carried by floodwaters striking against buildings and structures or parts thereof. These loads are of three basic types: normal, special and extreme.

- **Normal Impact Loads:** Normal impact loads are those that relate to isolated occurrences of loss, ice blocks or floatable objects of normally encountered sizes striking buildings or parts thereof.
- **Special Impact Loads:** Special impact loads are those that relate to large conglomerates of floatable objects, such as large trees or broken up ice floes and accumulation of floating debris, either striking or resting against a building, structure, or parts thereof.
- **Extreme Impact Loads:** Extreme impact loads are those that relate to large floatable objects and masses such as runaway barges or collapsed buildings and structures, striking the building, structure, or component under consideration.

Impact loads should be considered in the design of buildings, structures, and parts thereof, as follows:

- **Normal Impact Loads:** A concentrated load acting horizontally at the Design Flood level or at any point below it, equal to the impact force, produced by a 1,000-pound mass traveling at the velocity of the floodwater and acting on a one (1) square foot surface of the structure.

- **Special Impact Loads:** Where special impact loads are likely to occur, such loads shall be considered in the design of buildings, structures, or parts thereof. Unless a rational and detailed analysis is made ... the intensity of load shall be taken as 100 pounds per foot acting horizontally over a one-foot wide horizontal strip at the Design Flood level or at any level below it. Where natural or artificial barriers exist which would effectively prevent these special impact loads from occurring, the loads may be ignored in the design.
- **Extreme Impact Loads:** It is considered impractical to design buildings having adequate strength for resisting extreme impact loads. Accordingly, except for special cases when exposure to these loads is highly probable and the resulting damages are extremely severe, no allowances for these loads need be made in the design.

7. SOIL LOADS AND PRESSURE. Soil loads play a key role in the design of floodproofed structures. Active soil forces are generally expressed in terms of equivalent heavy fluid pressures. Various soil types have their own equivalent fluid pressure, with values ranging from 30 pounds per square foot (psf) to 120 psf. The applicability of soil loads to floodproofing and allowable soil pressures are adapted from *Flood-Proofing Regulations* as follows:

a) Soil Load(s). Full consideration should be given in the design of buildings, structures, and parts thereof, to the loads or pressures resulting from the presence of soils against or over the structure. Loads or pressures should be computed in accordance with accepted engineering practice, giving full consideration to the effects that the presence of floodwater, above or within the soil, has on loads and pressures. When expansive soils are present, special provisions may be made in foundation and wall design and construction to safeguard against damage due to this expansiveness.

b) Allowable Soil Pressures: Under flood conditions, the bearing capacity of submerged soils is affected and reduced by the buoyancy effect of the water on the soil. For foundations of buildings and structures, the bearing capacity of soils should be evaluated by a recognized acceptable method. Expansive soils should be investigated with special care. Soils that lose all bearing capacity when saturated, or become 'liquefied', should not be used for supporting foundations.

8. EARTHQUAKE LOADS (EQ). Earthquake loads should be treated as specified in the applicable local building code.



C. PERFORMANCE CRITERIA

The performance criteria included in this section of the manual represent objectives that should be achieved in the design of floodproofed non-residential structures and associated service systems. These criteria are applicable to the permanent and contingent techniques described in Chapter 1 including: (1) elevation on fill or supporting columns, piles, posts, piers, or wall section, (2) watertight construction (through the use of interior and exterior membranes or sealants; integrally waterproofed concrete construction; and/or a full range of closure and flood shield assemblies), and (3) the use of floodwalls and earth levees.

It should be noted that the performance criteria are generally structured to indicate the desired attributes of a floodproofed structure without reference to specific construction techniques or materials. This format has been selected to facilitate and encourage the development of a full range of traditional and innovative designs that are equally effective in reducing flood damages.

Provisions included in the following criteria represent the minimum design requirements for floodproofing of non-residential structures. It must be understood that these criteria are generally limited to design factors that are directly related to flooding conditions. Therefore, the following performance criteria can only be used in association with all applicable local building codes and regulations.

Where applicable, the criteria listed in this section accord with the Corps of Engineers' *Flood-Proofing Regulations*.

1. CRITERIA 1 - STRENGTH:

a) **Elevation on Posts, Piers, or Walls and Watertight Structures.** All elevated and watertight buildings (including all closure, flood shield assemblies, utilities and service systems) should be designed to resist the following loads (as defined in Part B of this appendix) acting simultaneously:

LOADING	SAFETY FACTORS		CONDITION
	OVERTURNING/SLIDING		
(Eq. 1.11) $D + L + R + F + S$	1.5	1.5	Design Flood
(Eq. 1.12) $D + L + R + F + FI + S$	1.5	1.5	Design Flood + Impact
(Eq. 1.13) $D + L + R + W + F + FI + S$	1.5	1.5	Design Flood + Impact + Wind
(Eq. 1.14) $.9D + R + W + F + S$	1.33	1.33	Uplift and hydrostatic
(Eq. 1.15) $.9D + R + W + F + FI + S$	1.33	1.33	Uplift and hydrostatic

where,

D - Dead loads,

L - Live loads, as defined in the applicable building code for the structure.

R - Loads resulting from expansion, contraction, creep, swelling and shrinkage of structural components. Also includes forces due to movements resulting from differential settlement.

W - Wind loads (see applicable local code),

F - Flood loads caused by the Design Flood which include both hydrostatic and hydrodynamic forces,

FI - Flood impact loads,

S - Soil loads.

Structures on fill should be designed to resist the above loads with the exclusion of F and FI from the load equations.

b) **Floodwalls.** Floodwalls should be designed to resist the following loads (as defined in Part B of this appendix) acting simultaneously:

LOADING	SAFETY FACTORS		CONDITION
	OVERTURNING/SLIDING		
(Eq. 1.21) $D + S + F$	1.75	1.3	Design Flood
(Eq. 1.22) $D + F + FI + S$	1.5	1.1	Design Flood + Impact
(Eq. 1.23) $D + W + F + FI + S$	1.5	1.1	Design Flood + Impact + Wind
(Eq. 1.24) $D + F^* + S$	1.0	1.1	Flood to top of wall
(Eq. 1.25) $D + S + EQ$	1.5	1.1	Normal load + Earthquake
(Eq. 1.26) $D + W$	1.3	1.1	Construction phase
(Eq. 1.27) $D + S$	2.0	1.5	Normal condition

* Assumes that the hydrostatic head of water pressure is equal to the height of the wall

c) Commentary

The loading cases defined in Item 1.1 are to be used in association with *working stress* design methods. If *load factor* design analysis is used (as required in instances where the American Concrete Institute Building Code Requirements for Reinforced Concrete (ACI-318-71) is applicable) load factors should be applied as stated in the applicable standard; and flood loads (F) should be combined with the live loads (L), or incorporated as though it were a live load for loading conditions (1.11) and (1.14). In all other loading cases, flood loads (F) and flood impact loads (FI) are to be combined with wind loads (W) or factored as equivalent to W.

The load cases described in items (1.11) and (1.12) provide an appropriate margin of safety against excessive damage or structural collapse when subjected to the design flood. The margins of safety applied to floodproofed structures are intended to be no less than those applied to structures that are not subjected to flooding. These criteria are deemed as satisfied if stresses and deflections do not exceed the limits specified in applicable codes, and all loads specified herein. Maximum load values and member stresses must be calculated to include the combined effects of all normal loads required by applicable local codes, and those related to flood conditions.

It is assumed that the flood loads (F) may act on a structure for a period of days, and overstress conditions are not permissible. Flood Impact (FI) loads (from normal impact sources) are short-term loads. Therefore, the margin of safety against load combinations containing FI need not exceed that provided against wind or earthquake loads. If a structure is subject to special or extreme impact loads, no overstress should be used. The combination of earthquake and flood loads should not be considered simultaneously due to the low probability of occurrence.

2. CRITERIA 2 - STABILITY

a) **Elevation on Posts, Piles, Piers, or Walls and Watertight Structures.** All structures elevated on posts, piles, piers or walls and all watertight structures should be designed to provide a minimum safety factor of 1.5 against structure failure from sliding or overturning; and should have enough dead load weight to resist anticipated hydrostatic pressures, including uplift, from floodwater at the Design Flood level with a minimum safety factor of 1.33.

b) **Floodwalls.** All floodwalls should be designed with appropriate safety factors associated with each loading case as given above in Criteria 1.

c) Levees and Elevation on Fill. Fill material should be selected, placed and compacted in layers to ensure stability and impermeability during a Design Flood. Levee and elevated fill design should recognize the effects of saturation from floodwaters on slope stability, and uniform and differential settlement.

The applicable loading cases to be considered in the embankment and foundation design of low-level levees are as follows:

- End of Construction
- Sudden Drawdown
- Critical Flood Stage
- Steady Seepage from Full Flood Stage
- Earthquake

The end of construction case evaluates both the riverside and landside slopes at a point where the soil, usually impervious, has not yet had time to drain since being loaded. Excess pore water pressure is often present. The sudden drawdown case evaluates embankment stability where a prolonged flood saturates a major portion of the structure and then falls faster than the soil can drain. Excess pore water pressure can result and the riverside slope can possibly become unstable.

The critical flood state and the steady seepage from full flood are similar loading conditions. The first evaluates embankment stability for some intermediate prolonged flood stage which saturates the embankment resulting in a steady seepage condition, while the latter occurs when the water remains at near full flood sufficiently long enough such that the embankment becomes either fully or partially saturated and steady seepage occurs.

Earthquake loadings are not normally considered in analyzing the stability of levees because of the low probability of earthquakes coinciding with periods of high water. Levees constructed of loose cohesionless materials or founded on loose cohesionless materials are particularly susceptible to failure due to liquefaction during earthquakes. Depending on the severity of the expected earthquake and the

importance of the levee, seismic analyses to determine liquefaction susceptibility may be required.

d) Commentary

In cases when it is not practical to provide the required factor of safety against flotation by weight of the structure alone, tie-down or anchorage devices may be used to achieve structural stability. When these devices are used they must be designed to resist significant deterioration during the service life of the structure. Adequate anchorage must also be provided for all sealed conduits, tanks and similar structure of site components that could become buoyant and result in extreme damages during flooding conditions.



3. CRITERIA 3 - SCOUR AND DEBRIS ACCUMULATION

The following provisions apply to facilities that may be subjected to flow velocities in excess of 5 fps, and/or floating debris content.

a) Elevation on Posts, Piles, Piers or Walls. Structures elevated on posts, piles, piers or walls or other similar supports should have clear spacing of support members, measured perpendicular to the general direction of flood flow of not less than eight (8) feet apart at the closest point. The supports should, as far as practicable, be compact and free from unnecessary appendages which would tend to trap or restrict free passage of debris during a flood. Solid walls, or walled-in columns are permissible if oriented with the longest dimension of the member parallel to the flow. Bracing, where used to provide lateral stability should be of a type that causes the least obstruction to the flow and the least potential for trapping floating debris. The potential of surface scour around the supports should be recognized and protective measures provided.

b) Watertight Structures and Floodwalls. Watertight structures and floodwalls should be sited and/or designed to resist undermining of foundation elements as a result of scour and increased structural loads associated with extensive debris accumulation.

c) Levees and Elevation on Fill. Levees and elevated fill areas should be designed to resist the effects of scour. For slopes exposed to flood velocities of less than 5 fps, grass or comparable vegetation may be used to provide adequate protection from scour. For areas subject to higher velocities, stone, concrete or some other durable material shall be used to prevent excessive scour.

d) Commentary. Protection against scour may include paving or riprapping of foundations, levees or earthfill areas. Consideration should also be given to landscaping features or the construction of flood flow diverters or barriers near the upstream side of the structure to reduce flood velocities and the associated impacts of scour and debris accumulation.

4. CRITERIA 4 - PERMEABILITY AND STORM DRAINAGE

a) Watertight Structures. Buildings and associated structures that are protected from the Design Flood by permanent closures, flood shields and related techniques must remain substantially impermeable to water. This requirement applies to the total structure including walls and floors that are below grade elevation. Slight seepage may be allowed in cases where resulting damages would be negligible, and where seepage can be easily collected at a sump and pumped out of the structure. Acceptable seepage rates should not exceed an amount which would result in accumulation of more than four (4) inches of water depth during a 24-hour period, if there were no devices provided for its removal. However, sump pumps would be required to control such seepage.

b) Floodwalls and Levees. Floodwalls and levees should be designed and constructed to minimize seepage through or under the structure during a Design Flood event. Provisions should also be made to collect all seepage and storm water that collects behind the levee or floodwall and pump this water from the dry to the wet side of the structure.

c) Commentary. To meet the requirements stated in item b, watertight construction must incorporate the following minimum design considerations:

- All expansion and construction joints shall be constructed with appropriate waterstops and joint sealing material. To prevent excess seepage at these tension zones, the maximum deflection of any structural floor slab or exterior wall shall not exceed 1/500 of its shorter span.
- Structure design may include the use of impervious barriers or cutoffs around the building perimeter to decrease the potential for the development of full hydrostatic uplift pressures and related seepage. These cutoffs must be connected to the impervious membrane of the building walls to operate effectively.

- * Watertight closures or shields must be provided for all doors, windows, grilles, vents and other openings that are below the Design Flood level. Whenever structure utility system components extend through the watertight wall, the openings must be sealed to eliminate seepage.

To meet the requirements of item b, it may be necessary to provide impervious cutoffs to prevent seepage beneath the wall or levee. This requirement is critical for structures that are designed on highly pervious foundation materials. It may also be necessary to construct a drainage system parallel to the interior base of the structure to collect seepage through or under the structure and normal surface runoff from the watershed above the structure. All seepage and storm drainage should be diverted to an appropriate number of sumps and pumped to the floodwater side of the structure. Spacing, sizing and determination of depth of sumps should be consistent with the intended drainage system, the estimated amount of seepage and drainage yield. Normal surface runoff into the protected area (during non-flood conditions) may normally be discharged through piles or culverts that are fitted with appropriate backflow prevention valves.

5. CRITERIA 5 - ELECTRICAL SYSTEMS

a) Main Power Disconnect. Provisions should be made to ensure that the main power service to any floodproofed structure can be disconnected at a single location that is readily accessible at the peak of a Design Flood. This main switch should control all electrical circuits throughout the building, with the exception of emergency lighting circuits.

b) Emergency Lighting. For buildings that may require emergency evacuation operations, or that may require personnel to occupy the building during flooding conditions to install or operate floodproofing measures, an emergency lighting system shall be installed. The emergency lighting system should be totally installed above the Design Flood elevation, be equipped with a separate distribution panel; and be powered by a source that will not be affected by the Design Flood.

c) Electrical Equipment. Whenever possible, all major electrical control panels, transformers, stationary equipment, elevator power equipment and similar items should be located above the Design Flood. Moveable electrical equipment may be located below the Design Flood if it is equipped with submersible quick-disconnects; and if provisions are made for elevating the equipment above anticipated flood level. All electrical equipment that is permanently installed below the design flood elevation should be of the submersible type.

d) Wiring. All wiring installed below the Design Flood level should be suitable for continuous submergence in water, with submersible type splices. All electrical conduits subject to flooding should be self-draining.

e) Sump Pumps. Buildings and structures that require sump pump equipment should provide automatic starting generators located above the Design Flood level. This equipment shall be capable of continuous operation for a minimum period of 125% of the estimated period water will be in contact with the structure during the Design Flood.

6. CRITERIA 6 - HEATING, AIR CONDITIONING AND VENTILATION

a) Location. All heating, air conditioning and ventilation equipment should be located above the Design Flood level whenever possible. When elevation is not feasible, this equipment may be located below the Design Flood in areas that are essentially watertight (see Criteria 4.1).

b) Heating and Air Conditioning. All gas or oil operated systems that are located below the Design Flood level should be equipped with automatic shut-off valves that are activated by rising flood waters. All heating equipment should be vented to a level above the Design Flood.

c) **Ventilation.** All duct work that is located below the Design Flood level should be installed to ensure positive drainage to a sufficient number of openings provided for that purpose. Sufficient anchorage and strength provisions should be made for any sealed conduit systems. Where duct work extends through a watertight floor or wall, the duct should be equipped with a closure assembly that can be operated from a position above the Design Flood.

d) **Fuel Tanks and Lines.** Liquid fuel and gas storage tanks should be elevated above the Design Flood Level; or anchored and protected from flotation and floodwater velocity and impact forces. The anchorage system should have a factor of safety of at least 1.5 against flotation. If it is exposed to stream flow or impact, it must be anchored to resist those forces.

All supply lines that are exposed to flood waters should be protected from hydrodynamic and impact forces, and equipped with automatic shut-off valves to prevent liquid or gas fuel spillage in the event of line failure. All storage tanks should be vented to a level above the Design Flood.

7. CRITERIA 7 - PLUMBING SYSTEMS

a) **General.** All plumbing system components that are installed below the Design Flood level should be designed to minimize loss of stability or tightness that may permit infiltration of floodwaters or permanently impair the function of the system.

b) **Sanitary Sewer System.** New and replacement sanitary sewage systems should be designed to minimize or eliminate infiltration of floodwaters into the systems and discharge from the systems into floodwaters. On-site waste disposal systems should be located to avoid impairment to them or contamination from them during flooding.

Sanitary sewer systems (including septic tank systems) that must remain in operation during a flood should be designed with a sealed holding tank and necessary mechanical controls to prevent sewage discharge during a flood. The holding tank should be sized to accommodate 150% of the demand that is anticipated for the duration of the Design Flood. All

vents should extend above the Design Flood level.

c) **Water Supply System.** Potable water supply systems should be designed to prevent contamination from floodwater up to the Design Flood level. Private potable wells should not be developed from a water table that is less than 25 feet below the ground surface, or from any source that may be directly polluted by floodwater. Private wells should be protected with a water-tight casing that is sealed at the bottom of the well in an impermeable stratum, or extends several feet into the water bearing stratum. If the pumping system is above ground, it shall be protected by a watertight enclosure or by adequate elevation. All vents should extend above the Design Flood level.

If the source of the water supply is public, the owner of the structure needs to follow the directions of local authorities during flooding conditions. If the function of the facility is critical, the owner may want to consider a water storage system for emergency use.

d) **Backflow Prevention.** Each storm drainage and sanitary sewer line that enters a structure below the Design Flood level should be provided with an automatic and/or manual backflow prevention device. Approved backflow prevention devices should also be installed on main water service lines at water wells, and/or at building entry locations to protect the water system from floodwater backflow or siphonage that could result from a water line break.

8. CRITERIA 8 - FLOODPROOFING OPERATIONS

a) Efficiency of Installation. All contingent floodproofing measures should be designed and maintained to facilitate safe and efficient implementation upon receipt of flood warning. The installation time requirements can not exceed the advance warning capabilities of the warning system that is in affect for the area.

b) Training and Preparedness Planning. All personnel that are required for the installation and/or operation of contingent floodproofing measures should be trained to minimize the risk of system failure resulting from an improper or incomplete floodproofing response. A comprehensive and detailed floodproofing Preparedness Plan should be developed and maintained to clearly document all floodproofing system maintenance and operational procedures.

9. CRITERIA 9 - RESCUE OPERATIONS

Whenever possible, floodproofed buildings should be designed to provide direct access to land areas that are above the Design Flood through site grading, walkways or similar methods. For structures where this is not feasible, and where flood depths will exceed 2 feet or velocities exceed 3 feet per second, the structure should be designed to prevent the entrapment of building occupants by rising floodwaters. An enclosed refuge space should be provided in an area above the Design Flood that provides sufficient space for all occupants. This space should be provided with an appropriate number of exterior exits to a space that will allow the safe transfer of occupants from the building to rescue vehicles.

The determination of flood-depths at a structure requires a interaction of the flood-hazard boundary map and the stream profile map with field activity to translate flood elevations to flood depths. Both maps are **contained** within the detailed Flood Insurance Study for a municipality or specific unincorporated areas. The procedure was adapted from the report entitled *Floodplain Regulations-To Encourage Wise Use and Reduce Flood Damage* and subsequent workshop of the Tennessee Valley Authority Office of Community Development.

A. FLOOD-HAZARD BOUNDARY MAP

This map will be used to correlate the location of a structure or structures to the flooding source. The Flood-Hazard Boundary Map (FHBM), Figure F-1, is similar to a city or road map. It has street names, the stream name and flood boundaries. On the stream are reference marks, usually in stream miles, above the mouth, which will be used to find the location of the structure on the profile.

The location of a structure may be determined in stream miles by using the following four steps.

Step 1: Locate the structure on the Flood-Hazard Boundary Map (Figure 1)

- a. Identify map features, such as street intersections, which are close to the structures.
- b. Select the most prominent ground feature nearest the structure.
- c. **In the field, measure** the distance and direction from the ground feature to the structure either by pacing or through more accurate taping.
- d. Check on availability of aerial photographs which can aid in relating ground features to the FHBM and vice versa. These photographs may be available from city or county governments, local engineering firms, the Department of Transportation or the Soil Conservation Service.
- e. **Transfer** location of structure to the FHBM by scaling the distance on the map.



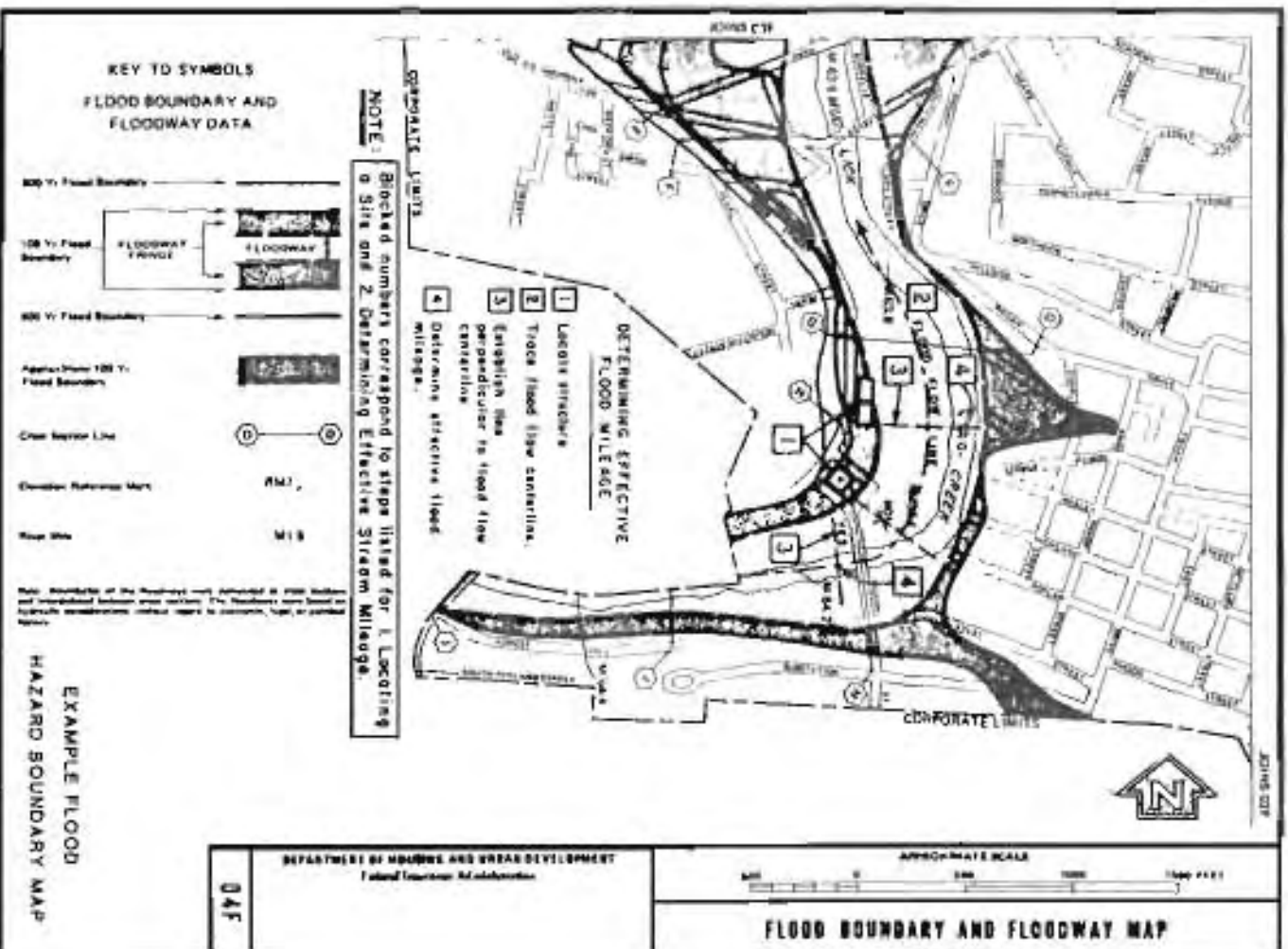

FIGURE F-1

Step 2: Trace the floodflow centerline

Draw a line on the map that represents the general direction of *floodflow* (shown as the floodflow line). This line should be approximately in the middle of the flood boundaries.

Step 3: Establish a line perpendicular to the floodflow centerline.

Align a straight edge *perpendicular to the floodflow line* (not the stream necessarily) and intersect the *most upstream side* or corner of the site or building. Notice that for building A two lines (both perpendicular to the floodflow line) have been drawn to illustrate the proper and improper ways for determining the effective stream mileage. When more than one line can be drawn to an upstream side or corner, the most upstream perpendicular line is the appropriate one for determining the effective mileage because it results in the highest applicable flood elevation for the site (flood elevations increase in the upstream direction).

Step 4: Determine the effective flood mileage.

The point where the perpendicular line intersects the centerline of the *stream* determines the effective mileage to be used when obtaining applicable flood elevations from the profile. For location A, measure effective mileage as 64.2 and for location B the effective mileage is 64.0. Very accurate results can be obtained using a precise scale and instrument which results in effective mileages for locations A and B as 64.16 and 63.97, respectively.

B. FLOOD PROFILE

The flood profile is used to determine applicable flood elevations. The flood elevations at the structure can be obtained from the profile after the effective stream mileage has been established from the flood-hazard boundary map. The following steps illustrate how to use the effective mileage and the profile to obtain the flood elevations shown in Figure F-2.

Step 1:

Place a straight edge along the vertical axis which matches the effective mileage and trace a light line where it will cross the profile lines.

Step 2:

At the points where the effective mileage line crosses the flood profile lines, read the pertinent elevation(s) along the horizontal grid or mark them with a horizontal line for future reference.

Step 3:

The profile indicates the 100-year flood elevations for the example as:

Location A = 2593.7 (using next highest foot = 2594)

Location B = 2592.0 (use 2592)

Other flood elevations which can be read from the sample profiles are indicated below (Table 1).

TABLE 1
PROFILE ELEVATIONS

FLOOD FREQUENCY	ELEVATION	
	Location A	Location B
10-Year	2586.7	2583.9
50-Year	2591.1	2588.3
500-Year	2597.4	2596.3

All map and profile readings should be carefully checked before they are used. It is suggested that readings be made by two individuals and the answers compared. Completion of the above process provides a flood elevation which can be used to:

- Determine flood depth
- Establish a construction elevation for a floor or earthfill to meet local ordinance or flood insurance requirements.

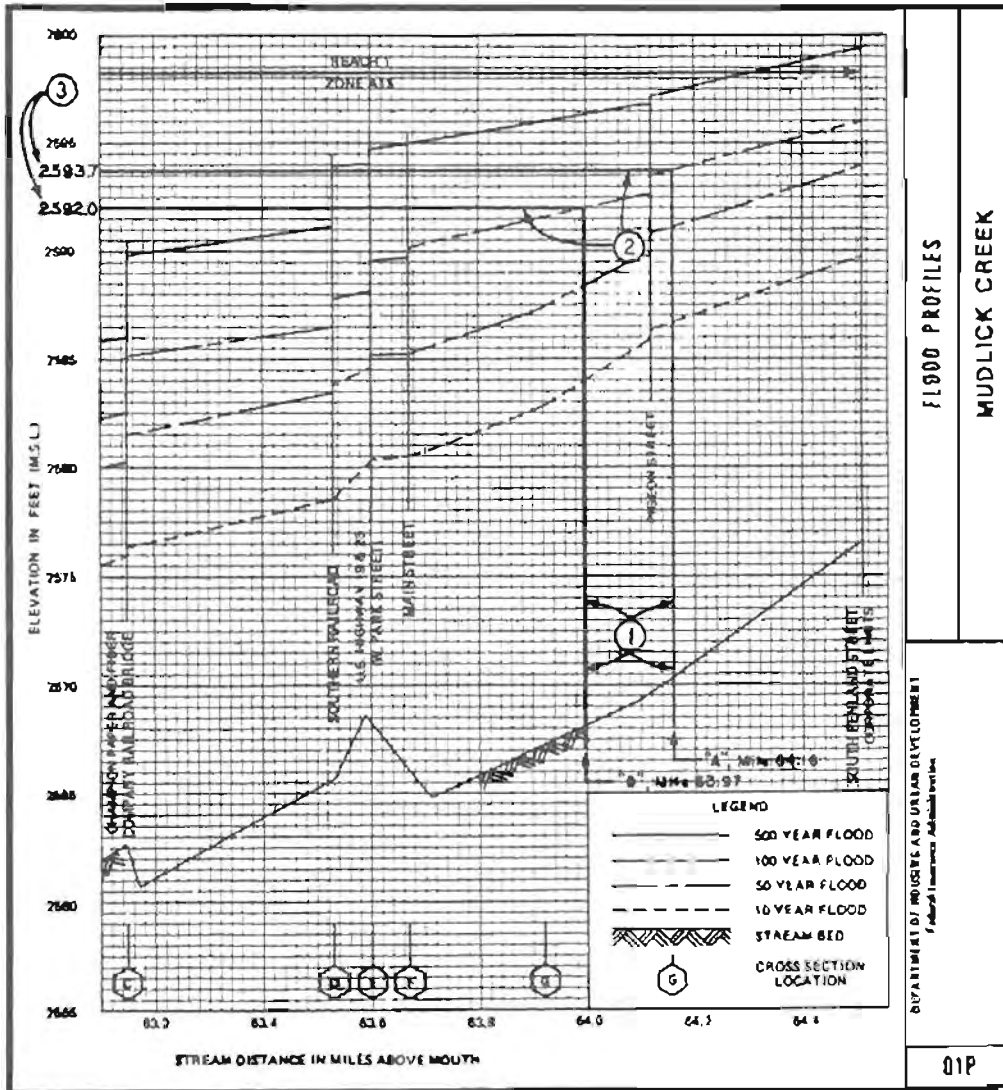

FIGURE F-2
EXAMPLE FLOOD PROFILE

Circled numbers correspond to steps listed for determining applicable flood elevations

C. DEPTH OF FLOODING

The preceding methods were used to determine the anticipated elevation of flood waters. A final step must be accomplished to find the elevation of the structure or the depth of the flood water at the structure. This can be accomplished by three different procedures. These include a field survey, the use of a hand-level or the use of a U.S.G.S. topographic map. The reliability of the information decreases in order of their presentation above. Each of the three methods is further defined in the following paragraphs.

1. FIELD SURVEY. A field survey is the most accurate technique for the establishment of flood depths at the structure. The procedure requires the use of land surveying techniques performed by a licensed land surveyor or registered professional engineer. The field survey will use benchmarks (fixed elevations) to align the flood level with reference to the ground at the structure, and therefore, determine the height of water at or upon the structure for a given flood.

2. HAND-LEVEL. This method can be accomplished provided a benchmark or known elevation is within sight of the structure. For example, the elevation at the benchmark was 963 feet and the elevation of the 100-year base flood was 969 feet. A six-foot rod or pole could be placed on the benchmark and a line sighted through the hand-level to a point on the wall of the structure. The imaginary line strikes the structure at a point two feet above the ground level of the structure. Since the imaginary line approximates the 100-year base flood elevation, it can be estimated that the base flood would be two feet high at the structure. Consequently, the two-foot water depth must be used in the consideration of optional floodproofing techniques.

3. U.S.G.S. TOPOGRAPHIC MAPS. Topographic maps illustrate elevations through a series of lines known as contours. Benchmarks and structures (depending upon the original or revised date of the map) are also portrayed on the maps. As in the previous examples, the benchmark of 963 feet would be identified on the map. The base flood level was determined as 969 feet so one would need to locate

the 970-foot contour line and trace its path toward the structure. Any site or structure located on the 970-foot contour would probably be safe from the base flood. The structure in the previous example will in all probability be partially situated inside the 970-foot contour and consequently within the potential flood-hazard boundary of the base flood. The actual height of the flood water at the structure, however, can only be estimated by locating the lowest contour that is near the structure in question. Subtracting this contour, assume it is 967, from the 100-year flood elevation 969. The difference, 2 feet, is the flood depth for this structure.

